

# Aspire 4930/4930G Series Service Guide

Service guide files and updates are available on the ACER/CSD web; for more information, please refer to <http://csd.acer.com.tw>

PRINTED IN TAIWAN

---

# Revision History

Please refer to the table below for the updates made on Aspire 4930 Series service guide.

Date	Chapter	Updates

---

## Copyright

Copyright © 2008 by Acer Incorporated. All rights reserved. No part of this publication may be reproduced, transmitted, transcribed, stored in a retrieval system, or translated into any language or computer language, in any form or by any means, electronic, mechanical, magnetic, optical, chemical, manual or otherwise, without the prior written permission of Acer Incorporated.

## Disclaimer

The information in this guide is subject to change without notice.

Acer Incorporated makes no representations or warranties, either expressed or implied, with respect to the contents hereof and specifically disclaims any warranties of merchantability or fitness for any particular purpose. Any Acer Incorporated software described in this manual is sold or licensed "as is". Should the programs prove defective following their purchase, the buyer (and not Acer Incorporated, its distributor, or its dealer) assumes the entire cost of all necessary servicing, repair, and any incidental or consequential damages resulting from any defect in the software.

Acer is a registered trademark of Acer Corporation.

Intel is a registered trademark of Intel Corporation.

Pentium and Pentium II/III are trademarks of Intel Corporation.

Other brand and product names are trademarks and/or registered trademarks of their respective holders.

---

## Conventions

The following conventions are used in this manual:

<b>SCREEN MESSAGES</b>	Denotes actual messages that appear on screen.
<b>NOTE</b>	Gives bits and pieces of additional information related to the current topic.
<b>WARNING</b>	Alerts you to any damage that might result from doing or not doing specific actions.
<b>CAUTION</b>	Gives precautionary measures to avoid possible hardware or software problems.
<b>IMPORTANT</b>	Reminds you to do specific actions relevant to the accomplishment of procedures.

---

## Preface

Before using this information and the product it supports, please read the following general information.

1. This Service Guide provides you with all technical information relating to the BASIC CONFIGURATION decided for Acer's "global" product offering. To better fit local market requirements and enhance product competitiveness, your regional office MAY have decided to extend the functionality of a machine (e.g. add-on card, modem, or extra memory capability). These LOCALIZED FEATURES will NOT be covered in this generic service guide. In such cases, please contact your regional offices or the responsible personnel/channel to provide you with further technical details.
2. Please note WHEN ORDERING FRU PARTS, that you should check the most up-to-date information available on your regional web or channel. If, for whatever reason, a part number change is made, it will not be noted in the printed Service Guide. For ACER-AUTHORIZED SERVICE PROVIDERS, your Acer office may have a DIFFERENT part number code to those given in the FRU list of this printed Service Guide. You MUST use the list provided by your regional Acer office to order FRU parts for repair and service of customer machines.



# Table of Contents

<b>System Specifications</b>	<b>1</b>
Features	1
System Block Diagram	4
Your Acer Notebook tour	5
Front View	5
Closed Front View	6
Left View	7
Right View	8
Rear View	8
Bottom View	9
Indicators	10
Easy-Launch Buttons	11
Touch Pad Basics (with fingerprint reader)	12
Using the Keyboard	13
Lock Keys and embedded numeric keypad	13
Windows Keys	14
Hot Keys	15
Special Key	16
Acer Empowering Technology	17
Empowering Technology password	17
Acer eNet Management	18
Acer ePower Management	19
Acer eAudio Management	21
Acer ePresentation Management	22
Acer eDataSecurity Management (for selected models)	23
Acer eLock Management	24
Acer eRecovery Management	25
Acer eSettings Management	26
Windows Mobility Center	27
Using the System Utilities	28
Acer GridVista (dual-display compatible)	28
Launch Manager	29
Norton Internet Security	30
Hardware Specifications and Configurations	31
<b>System Utilities</b>	<b>39</b>
BIOS Setup Utility	39
Navigating the BIOS Utility	39
Information	40
Main	41
Advanced	42
Security	44
Power	47
Boot	49
Exit	50
BIOS Flash Utility	51
Remove HDD/BIOS Utility	52
<b>Machine Disassembly and Replacement</b>	<b>57</b>
Disassembly Requirements	57
General Information	58
Pre-disassembly Instructions	58
Disassembly Process	58
External Module Disassembly Process	59

# Table of Contents

External Modules Disassembly Flowchart	59
Removing the Battery Pack	60
Removing the SD dummy card	61
Removing the ExpressCard dummy card	62
Removing the Lower Covers	63
Removing the DIMM Module	65
Removing the WLAN Board Module	66
Removing the Hard Disk Drive Module	68
Removing the Optical Drive Module	70
Main Unit Disassembly Process	73
Main Unit Disassembly Flowchart	73
Removing the Switch Cover	74
Removing the Keyboard	76
Removing the Antenna	78
Removing the LCD Module	82
Removing the Upper Cover	84
Removing the Touch Pad Bracket	88
Removing the Finger Print Reader	91
Removing the Launch Board	93
Removing the Speaker Module	95
Removing the Switch Board	97
Removing the Touch Pad Board	98
Removing the I/O Board	99
Removing the Bluetooth board	101
Removing the Modem Module	103
Removing the Main Board	106
Removing the Thermal Module	110
Removing the CPU	112
Removing the CPU Fan	114
Removing the HDMI Module	116
LCD Module Disassembly Process	118
LCD Module Disassembly Flowchart	118
Removing the LCD Bezel	119
Removing the Inverter Board	121
Removing the Camera Module	123
Removing the LCD Panel	125
Removing the LCD Brackets and FPC Cable	126
Removing the Antennas	129
Removing the MIC Module	131
LCM Module Reassembly Procedure	132
Replacing the LCD Panel	132
Replacing the LCM Bezel	134
Main Module Reassembly Procedure	135
Replacing the CPU	135
Replacing the Thermal Module	135
Replacing the CPU Fan Module	136
Replacing the HDMI Module	136
Replacing the Mainboard	137
Replacing the I/O Board	138
Replacing the Bluetooth Board	138
Replacing the Modem Module	139
Replacing the Finger Print Reader	140
Replacing the Touch Pad	141
Replacing the Launch Board	142
Replacing the Switch Board	142



# Table of Contents

Replacing the Antenna Cables	143
Replacing the Speaker Module	144
Replacing the Keyboard	144
Replacing the Switch Cover	145
Replacing the WLAN Module	145
Replacing the Hard Disk Drive Module	146
Replacing the DIMM Modules	147
Replacing the ODD Module	148
Replacing the Lower Covers	148
Replacing the Express and SD Card Trays	149
<b>Troubleshooting</b>	<b>151</b>
Common Problems	151
Power On Issue	152
No Display Issue	153
Random Loss of BIOS Settings	154
LCD Failure	155
Built-In Keyboard Failure	155
Touch Pad Failure	156
Internal Speaker Failure	156
Internal Microphone Failure	158
HDD Not Operating Correctly	159
ODD Failure	160
USB Failure (Rightside)	163
Modem Function Failure	163
Wireless Function Failure	164
EasyTouch Button Failure	164
MediaTouch Button Failure	165
Fingerprint Reader Failure	165
Thermal Unit Failure	166
HDTV Switch Failure	166
External Mouse Failure	167
Other Failures	167
Intermittent Problems	168
Undetermined Problems	168
<b>Jumper and Connector Locations</b>	<b>169</b>
Top View	169
Bottom View	170
Clearing Password Check and BIOS Recovery	171
Clearing Password Check	171
BIOS Recovery by Crisis Disk	172
<b>FRU (Field Replaceable Unit) List</b>	<b>173</b>
Aspire 4930 Exploded Diagram	174
<b>Model Definition and Configuration</b>	<b>182</b>
Aspire 4930 Series	182
<b>Test Compatible Components</b>	<b>205</b>
Microsoft® Windows® Vista Environment Test	206
<b>Online Support Information</b>	<b>209</b>
<b>Index</b>	<b>211</b>

# ***Table of Contents***

# System Specifications

---

## Features

Below is a brief summary of the computer's many feature:

### Operating System

- Windows® Vista™

### Platform

- Intel® Centrino® 2 processor technology, featuring:
  - Intel® Core™2 Duo processor\*
  - Mobile Intel® PM45/GM45 Express Chipset\*
  - Intel® Wireless WiFi Link 5100/5300, 5150/5350\*

### System Memory

- Dual-Channel DDR2 SDRAM support
- Up to 2 GB of DDR2 667 MHz memory, upgradeable to 4 GB using two soDIMM modules\*

### TV Tuner

- Digital TV-tuner supporting DVB-T\*

### Display and graphics

- 14.1" WXGA 1280 x 800
- Mobile Intel® GM45 Express Chipset
- NVIDIA GeForce 9300M GS / 9600M GT (For Aspire 4390G only)

### Storage subsystem

- 2.5" hard disk drive
- Optical drive options:
  - Blu-ray Disc™ /DVD-Super Multi double-layerdrive
  - DVD-Super Multi double-layer drive
- 5-in-1 card reader

### Audio

- Dolby-certified surround sound system with two built-in stereo speakers and one subwoofer supporting low-frequency effects
- S/PDIF (Sony/Philips Digital Interface) support for digital speakers
- Acer PureZone technology with two built-in stereo microphones

---

## Dimensions and Weight

- 340.4 (W) x 247 (D) x 22.9/42.3 (H) mm (13.4 x 9.7 x 0.9/1.6 inches)
- 2.4 kg (5.29 lbs.)

## Communication

- Acer Video Conference, featuring:
  - Integrated Acer Crystal Eye webcam
  - Acer Video Conference Manager software
  - Acer PureZone technology
  - Optional Acer Xpress VoIP phone
- WLAN: Intel® Wireless WiFi Link 5100/5300\*
- WiFi®/WiMAX™: Intel® Wireless WiFi Link 5150/5350\*
- WPAN: Bluetooth® 2.0+EDR (Enhanced Data Rate)
- LAN: Gigabit Ethernet; Wake-on-LAN ready
- Modem: 56K ITU V.92

## Privacy control

- Acer Bio-Protection fingerprint solution
- BIOS user, supervisor, HDD passwords
- Kensington lock slot

## Power subsystem

- ACPI 3.0
- 48.8 W 4400 mAh\*
- 3-pin 90 W AC adapter\*
- 3-pin 65 W AC adapter\*
- Energy Star 4.0

## Special keys and controls

- 88-/89-/93-key keyboard
- Touch Pad pointing device
- Empowering Key
- Easy-launch buttons: WLAN, Internet, email, Bluetooth, Acer Arcade™
- Acer MediaTouch keys: play/pause, stop, previous, next and record keys
- Volume wheel
- Acer Media Center remote control\*

## I/O interface

- Acer EasyPort IV connector
- ExpressCard™/54 slot
- 5-in-1 card reader (SD/MMC/MS/MS PRO/xD)

- 
- 3 USB 2.0 ports
  - HDMI™ port with HDCP support
  - Consumer infrared (CIR) port
  - External display (VGA) port
  - Headphones/speaker/line-out port with S/PDIF support
  - Microphone-in jack
  - Line-in jack
  - Ethernet (RJ-45) port
  - Modem (RJ-11) port
  - DC-in jack for AC adapter

## Environment

- Temperature:
  - Operating: 5 °C to 35 °C
  - Non-operating: -20 °C to 65 °C
- Humidity (non-condensing):
  - Operating: 20% to 80%
  - Non-operating: 20% to 80%

**NOTE:** Items marked with \* denote only selected models.

# System Block Diagram

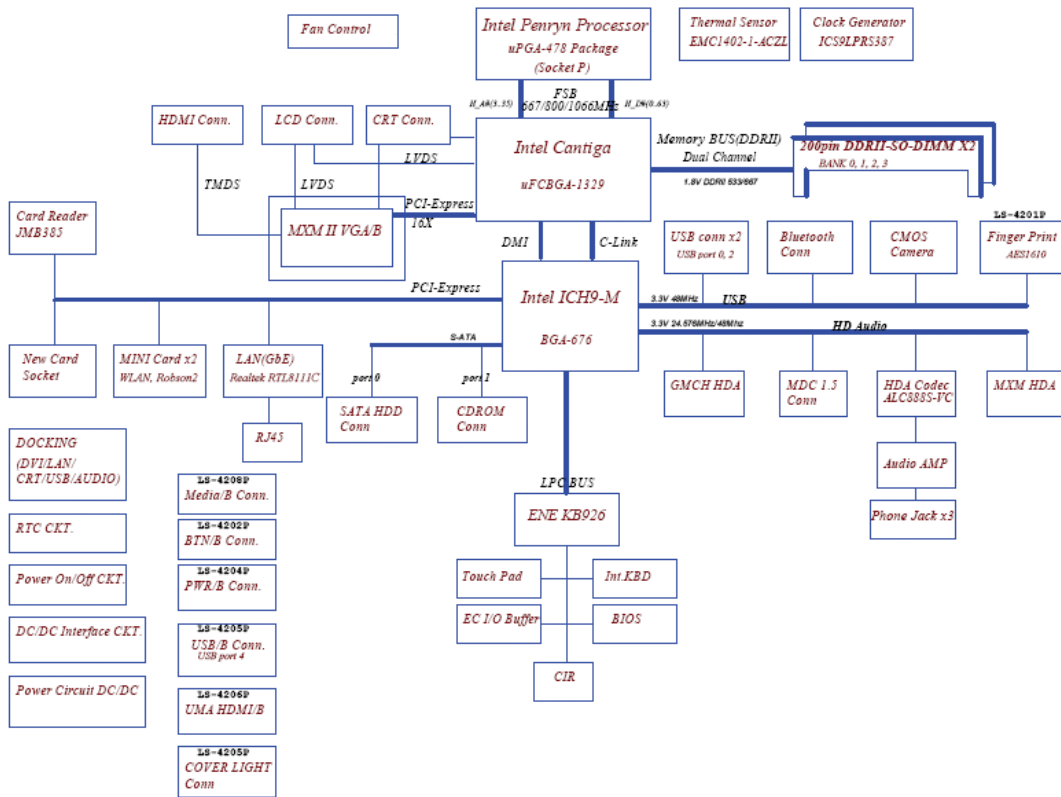



# Your Acer Notebook tour

After knowing your computer features, let us show you around your new computer.

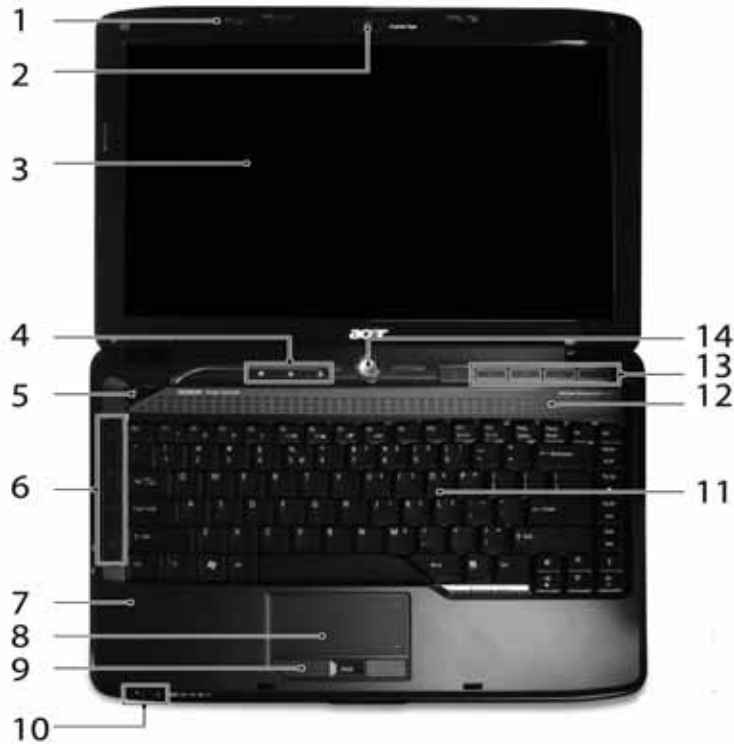
## Front View





No.	Icon	Item	Description
1		Acer PureZone	Two internal stereo microphones for sound recording.
2		Acer Crystal Eye	Web camera for video communication.
3		Display screen	Also called Liquid-Crystal Display (LCD), displays computer output.
4		Status indicators	Light-Emitting Diodes (LEDs) that light up to show the status of the computer's functions and components.
5		Empowering key	Launch Acer Empowering Technology
6		Easy-launch buttons	Buttons for launching frequently used program.
7		Palmrest	Comfortable support area for your hands when you use the computer.
8		Touch Pad	Touch-sensitive pointing device which functions like a computer mouse.

No.	Icon	Item	Description
9		Click buttons (left, center* and right)	The left and right buttons function like the left and right mouse buttons. *The center button serves as Acer Bio-Protection fingerprint reader supporting Acer FingerNav 4-way control function.
10		Status indicators	Light-Emitting Diodes (LEDs) that light up to show the status of the computer's functions and components.
11		Keyboard	For entering data into your computer.
12		Speakers	Left and right speakers deliver stereo audio output.
13		Acer MediaTouch keys	For use with Acer Arcade and other media playing programs.
14		Power button	Turns the computer on and off.

## Closed Front View











No.	Icon	Item	Description
1		CIR receiver	Receives signals from a remote control.
2		5-in-1 card reader	Accepts Secure Digital (SD), MultiMediaCard (MMC), Memory Stick (MS), Memory Stick PRO (MS PRO), xD-Picture Card (xD).
3		Latch	Locks and releases the lid







# Left View



No.	Icon	Item	Description
1		Acer EasyPort IV connector	Connects to Acer EasyPort IV.
2		Ethernet (RJ-45) port	Connects to an Ethernet 10/100/1000-based network.
3		External display (VGA) port	Connects to a display device (e.g. external monitor, LCD projector).
4	HDMI	HDMI	Connects to a television or display device with HDMI input.
5		USB 2.0 ports	Connect to USB 2.0 devices (e.g. USB mouse, USB camera).
6		Line-in jack	Accepts audio line-in devices (e.g. audio CD player, stereo walkman).
7		Microphone-in jack	Accepts input from external microphones.
8		Headphones/speaker/line-out jack with S/PDIF support	Connects to audio line-out devices (e.g. speakers, headphones).
9		Unlimited volume control wheel	Adjust the volume of the audio-out.
10	ExpressCard / 54	ExpressCard/54 slot	Accepts one ExpressCard/54 module.

## Right View



No.	Icon	Item	Description
1		Kensington lock slot	Connects to a Kensington-compatible computer security lock.
2		Optical drive	Internal optical drive; accepts CDs or DVDs.
3		Optical disk access indicator	Lights up when the optical drive is active.
4		Optical drive eject button	Ejects the optical disk from the drive.
5		Emergency eject hole	Ejects the optical drive tray when the computer is turned off. <b>Note:</b> Insert a paper clip into the emergency eject hole to eject the optical drive tray when the computer is off.
6		Modem (RJ-11) port	Connects to a phone line.
7		USB 2.0 port	Connect to USB 2.0 devices (e.g. USB mouse, USB camera).
8		DC-in jack	Connects to an AC adapter





## Rear View

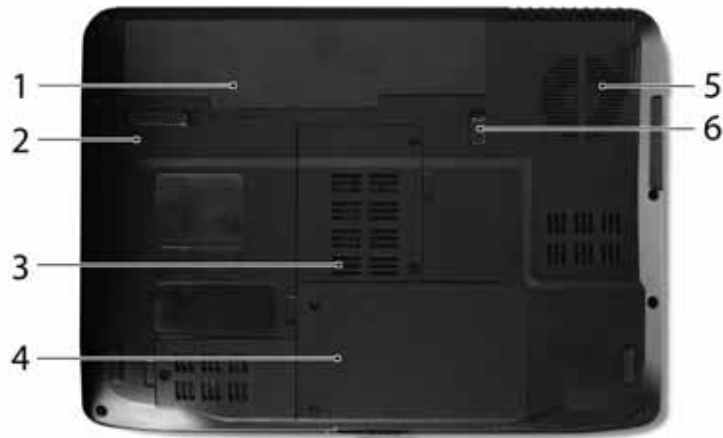

No.	Icon	Item	Description
1		Ventilation slots	Enable the computer to stay cool, even after prolonged use.

## Bottom View







No.	Icon	Item	Description
1		Battery bay	Houses the computer's battery pack.
2		Battery release latch	Releases the battery for removal.
3		Memory compartment	Houses the computer's main memory.
4		Hard disk bay	Houses the computer's hard disk (secured with screws).
5		Battery lock	Locks the battery in position.
6		Ventilation slots and cooling fan	Enable the computer to stay cool, even after prolonged use. <b>Note:</b> Do not cover or obstruct the opening of the fan.

---

# Indicators

The computer has several easy-to-read status indicators:

The front panel indicators are visible even when the computer cover is closed.

Icon	Function	Description
	Power	Indicates the computer's power status.
	Battery	Indicates the computer's battery status.
	HDD	Indicates when the hard disk drive is active.
	Num Lock	Lights up when Num Lock is activated.
	Caps Lock	Lights up when Caps Lock is activated.







**NOTE:** 1. **Charging:** The light shows amber when the battery is charging. 2. **Fully charged:** The light shows green when in AC mode.

---

## Easy-Launch Buttons

Located beside the keyboard are application buttons. These buttons are called easy-launch buttons. They are: WLAN, Internet, email, Bluetooth, Arcade and Acer Empowering Technology.

The mail and Web browser buttons are pre-set to email and Internet programs, but can be reset by users. To set the Web browser, mail and programmable buttons, run the Acer Launch Manager.

Icon	Function	Description
	Empowering Technology	Launch Acer Empowering Technology. (user-programmable)
	Acer Arcade	Launch Acer Arcade utility
	Wireless communication button/indicator	Enables/disables the wireless function. Indicates the status of wireless LAN communication.
	Web browser	Internet browser (user-Programmable)
	Mail	Email application (user-Programmable)
	Bluetooth communication button/indicator	Enables/disables the Bluetooth function. Indicates the status of Bluetooth communication.

# Touch Pad Basics (with fingerprint reader)

The following items show you how to use the Touch Pad with Acer Bio-Protection fingerprint reader:

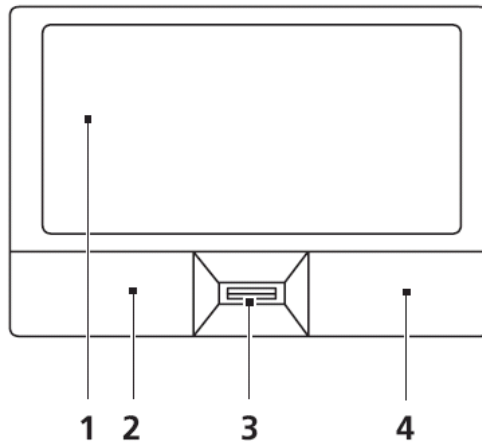

- Move your finger across the Touch Pad (2) to move the cursor.
- Press the left (1) and right (4) buttons located beneath the Touch Pad to perform selection and execution functions. These two buttons are similar to the left and right buttons on a mouse. Tapping on the Touch Pad is the same as clicking the left button.
- Use Acer Bio-Protection fingerprint reader (3) supporting Acer FingerNav 4-way control function (only for certain models) or the 4-way scroll (3) button (only for certain models) to scroll up or down and move left or right a page. This fingerprint reader or button mimics your cursor pressing on the right scroll bar of Windows applications.

Function	Left Button (1)	Right Button (3)	Main Touch Pad (2)
Execute	Quickly click twice.		Tap twice (at the same speed as double-clicking a mouse button).
Select	Click once.		Tap once.
Drag	Click and hold, then use finger on the Touch Pad to drag the cursor.		Tap twice (at the same speed as double-clicking a mouse button); rest your finger on the Touch Pad on the second tap and drag the cursor.
Access context menu		Click once.	

**NOTE:** When using the Touch Pad, keep it - and your fingers - dry and clean. The Touch Pad is sensitive to finger movement; hence, the lighter the touch, the better the response. Tapping too hard will not increase the Touch Pad's responsiveness.

# Using the Keyboard

The keyboard has full-sized keys and an embedded numeric keypad, separate cursor, lock, Windows, function and special keys.

## Lock Keys and embedded numeric keypad

The keyboard has three lock keys which you can toggle on and off.





















Lock key	Description
Caps Lock	When Caps Lock is on, all alphabetic characters typed are in uppercase.
Num Lock <Fn> + <F11>	When Num Lock is on, the embedded keypad is in numeric mode. The keys function as a calculator (complete with the arithmetic operators +, -, *, and /). Use this mode when you need to do a lot of numeric data entry. A better solution would be to connect an external keypad.
Scroll Lock <Fn> + <F12>	When Scroll Lock is on, the screen moves one line up or down when you press the up or down arrow keys respectively. Scroll Lock does not work with some applications.

The embedded numeric keypad functions like a desktop numeric keypad. It is indicated by small characters located on the upper right corner of the keycaps. To simplify the keyboard legend, cursor-control key symbols are not printed on the keys.

Desired access	Num Lock on	Num Lock off
Number keys on embedded keypad	Type numbers in a normal manner.	
Cursor-control keys on embedded keypad	Hold <Shift> while using cursor-control keys.	Hold <Fn> while using cursor-control keys.
Main keyboard keys	Hold <Fn> while typing letters on embedded keypad.	Type the letters in a normal manner.

# Windows Keys

The keyboard has two keys that perform Windows-specific functions.

Key	Description
 Windows key	<p>Pressed alone, this key has the same effect as clicking on the Windows Start button; it launches the Start menu. It can also be used with other keys to provide a variety of functions:</p> <ul style="list-style-type: none"> <li>&lt;  &gt; : Open or close the Start menu</li> <li>&lt;  &gt; + &lt;D&gt;: Display the desktop</li> <li>&lt;  &gt; + &lt;E&gt;: Open Windows Explore</li> <li>&lt;  &gt; + &lt;F&gt;: Search for a file or folder</li> <li>&lt;  &gt; + &lt;G&gt;: Cycle through Sidebar gadgets</li> <li>&lt;  &gt; + &lt;L&gt;: Lock your computer (if you are connected to a network domain), or switch users (if you're not connected to a network domain)</li> <li>&lt;  &gt; + &lt;M&gt;: Minimizes all windows</li> <li>&lt;  &gt; + &lt;R&gt;: Open the Run dialog box</li> <li>&lt;  &gt; + &lt;T&gt;: Cycle through programs on the taskbar</li> <li>&lt;  &gt; + &lt;U&gt;: Open Ease of Access Center</li> <li>&lt;  &gt; + &lt;X&gt;: Open Windows Mobility Center</li> <li>&lt;  &gt; + &lt;BREAK&gt;: Display the System Properties dialog box</li> <li>&lt;  &gt; + &lt;SHIFT+M&gt;: Restore minimized windows to the desktop</li> <li>&lt;  &gt; + &lt;TAB&gt;: Cycle through programs on the taskbar by using Windows Flip 3-D</li> <li>&lt;  &gt; + &lt;SPACEBAR&gt;: Bring all gadgets to the front and select Windows Sidebar</li> <li>&lt;CTRL&gt; + &lt;  &gt; + &lt;F&gt;: Search for computers (if you are on a network)</li> <li>&lt;CTRL&gt; + &lt;  &gt; + &lt;TAB&gt;: Use the arrow keys to cycle through programs on the taskbar by using Windows Flip 3-D</li> </ul> <p><b>Note:</b> Depending on your edition of Windows Vista, some shortcuts may not function as described.</p>
 Application key	<p>This key has the same effect as clicking the right mouse button; it opens the application's context menu.</p>



# Hot Keys

The computer employs hotkeys or key combinations to access most of the computer's controls like screen brightness, volume output and the BIOS utility.

To activate hot keys, press and hold the <Fn> key before pressing the other key in the hotkey combination.



Hotkey	Icon	Function	Description
<Fn> + <F1>	?	Hotkey help	Displays help on hotkeys.
<Fn> + <F2>		Acer eSettings Management	Launches Acer eSettings Management in Acer Empowering Technology.
<Fn> + <F3>		Acer ePower Management	Launches Acer ePower Management in Acer Empowering Technology.
<Fn> + <F4>	Z <sup>z</sup>	Sleep	Puts the computer in Sleep mode.
<Fn> + <F5>		Display toggle	Switches display output between the display screen, external monitor (if connected) and both.
<Fn> + <F6>		Screen blank	Turns the display screen backlight off to save power. Press any key to return.
<Fn> + <F7>		Touch Pad toggle	Turns the internal Touch Pad on and off.
<Fn> + <F8>		Speaker toggle	Turns the speakers on and off.
<Fn> + <F9>		Brightness up	Increases the screen brightness.
<Fn> + <F10>		Brightness down	Decreases the screen brightness.
<Fn> + <F11>	?	Hotkey help	Displays help on hotkeys.
<Fn> + <F12>		Acer eSettings Management	Launches Acer eSettings Management in Acer Empowering Technology.

---

## Special Key

You can locate the Euro symbol and the US dollar sign at the upper-center and/or bottom-right of your keyboard.



### The Euro symbol

1. Open a text editor or word processor.
2. Hold <Alt Gr> and then press the <5> key at the upper-center of the keyboard.

**NOTE: Note:** Some fonts and software do not support the Euro symbol. Please refer to [www.microsoft.com/typography/faq/faq12.htm](http://www.microsoft.com/typography/faq/faq12.htm) for more information.

### The US dollar sign

1. Open a text editor or word processor.
2. Hold <Shift> and then press the <4> key at the upper-center of the keyboard.

**NOTE:** This function varies by the operating system version.

---

# Acer Empowering Technology

The Empowering Technology toolbar makes it easy for you to access frequently used functions and manage your new Acer system. Displayed by default in the upper half of your screen, it provides access to the following utilities:

- **Acer eNet Management** hooks up to location-based networks intelligently.
- **Acer ePower Management** optimizes battery usage via customizable power plans.
- **Acer ePresentation Management** connects to a projector and adjusts display settings.
- **Acer eDataSecurity Management** protects data with passwords and encryption.
- **Acer eLock Management** limits access to external storage media.
- **Acer eRecovery Management** backs up and recovers data flexibly, reliably and completely.
- **Acer eSettings Management** accesses system information and adjusts settings easily.



For more information, right click on the Empowering Technology toolbar, then select the **"Help"** or **"Tutorial"** function.

## Empowering Technology password

Before using Acer eLock Management and Acer eRecovery Management, you must initialize the Empowering Technology password. Right-click on the Empowering Technology toolbar and select **"Password Setup"** to do so. If you have not initialized the Empowering Technology password and run Acer eLock Management or Acer eRecovery Management, you will be asked to create it.

**NOTE:** If you lose the Empowering Technology password, there is no way to reset it except by reformatting your system. Make sure to remember or write down your password!

# Acer eNet Management

Acer eNet Management helps you quickly connect to both wired and wireless networks in a variety of locations. To access this utility, select "**Acer eNet Management**" from the Empowering Technology toolbar or run the program from the Acer Empowering Technology program group in Start menu. You can also set Acer eNet Management to start automatically when you boot up your PC.

Acer eNet Management automatically detects the best settings for a new location, while offering you the option to manually adjust the settings to match your needs.



Acer eNet Management can save network settings for a location to a profile, and automatically switch to the appropriate profile when you move from one location to another. Settings stored include network connection settings (IP and DNS settings, wireless AP details, etc.), as well as default printer settings. Security and safety concerns mean that Acer eNet Management does not store username and password information.

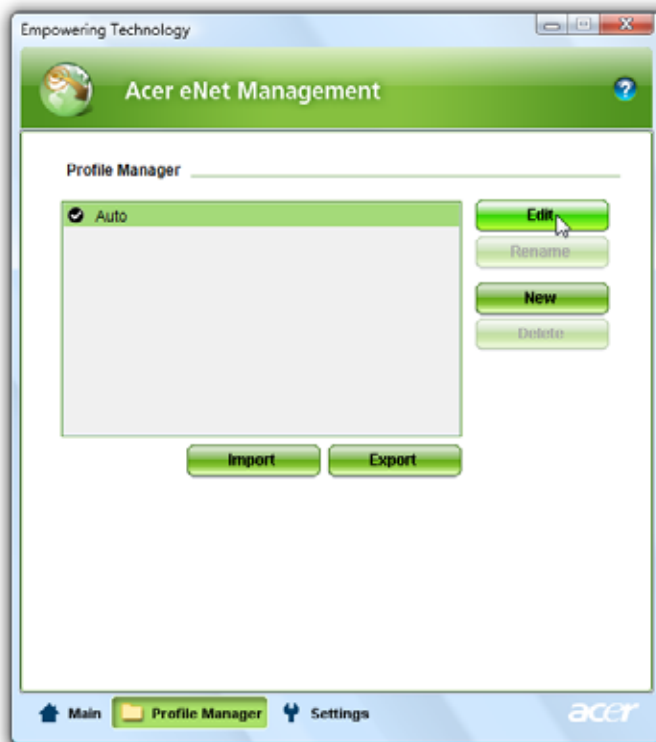

## Acer ePower Management

Acer ePower Management features a straightforward user interface for configuring your power management options. To access this utility, select "**Acer ePower Management**" from the Empowering Technology toolbar, run the program from the Acer Empowering Technology program group in Start menu, or right-click the Windows power icon in the system tray and select "**Acer ePower Management**".

### Using power plans

Acer ePower Management comes with three predefined power plans: Balanced, High performance and Power saver. You can also create customized power plans. You can create, switch between, edit, delete and restore power plans, as described below.

View and adjust settings for On Battery and Plugged In modes by clicking the appropriate tabs. You can open Windows power options by clicking "**More Power Options**".

**NOTE:** You cannot delete the predefined power plans.

### To create a new power plan:

Creating customized power plans allows you to save and quickly switch to a personalized set of power options.

1. Click the Create Power Plan icon. 
2. Enter a name for your new power plan.
3. Choose a predefined power plan to base your customized plan on.

4. If necessary, change the display and sleep settings you want your computer to use.
5. Click "OK" to save your new power plan.

### To switch between power plans:

1. Select the power plan you wish to switch to from the drop-down list.
2. Click "Apply".

### To edit a power plan:

Editing a power plan allows you to adjust system settings like LCD brightness and CPU speed. You can also turn on/off system components to extend battery life.

1. Switch to the power plan you wish to edit
2. Adjust settings as required.
3. Click "Apply" to save your new settings.

### To delete a power plan:

You cannot delete the power plan you are currently using. If you want to delete the active power plan, switch to another one first.

1. Select the power plan you wish to delete from the drop-down list.
2. Click the Delete Power Plan icon. 

### Battery status

For real-time battery life estimates based on current usage, refer to the panel in the upper half of the window.

Click the  to view estimated battery life in sleep and hibernate modes.

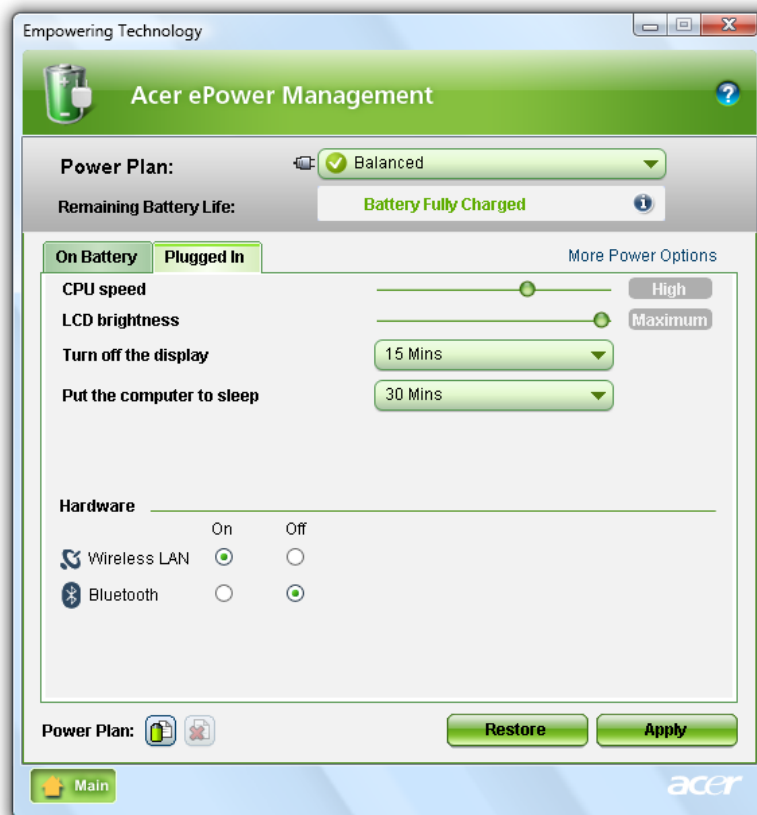

# Acer eAudio Management

Acer eAudio Management allows you to easily control the enhanced sound effects of Dolby® Home Theater™ on your system. Select "**Movie**" or "**Game**" mode to experience the awesome realism of 5.1-channel surround sound from just 2 speakers, via Dolby Virtual Speaker technology. "**Music**" mode lets you enjoy your favorite tunes, in vivid detail.



---

## Acer ePresentation Management

Acer ePresentation Management lets you project your computer's display to an external display device or projector using the hotkey: **<Fn> + <F5>**. If auto-detection hardware is implemented in the system and the external display supports it, your system display will be automatically switched out when an external display is connected to the system. For projectors and external devices that are not auto-detected, launch Acer ePresentation Management to choose an appropriate display setting.

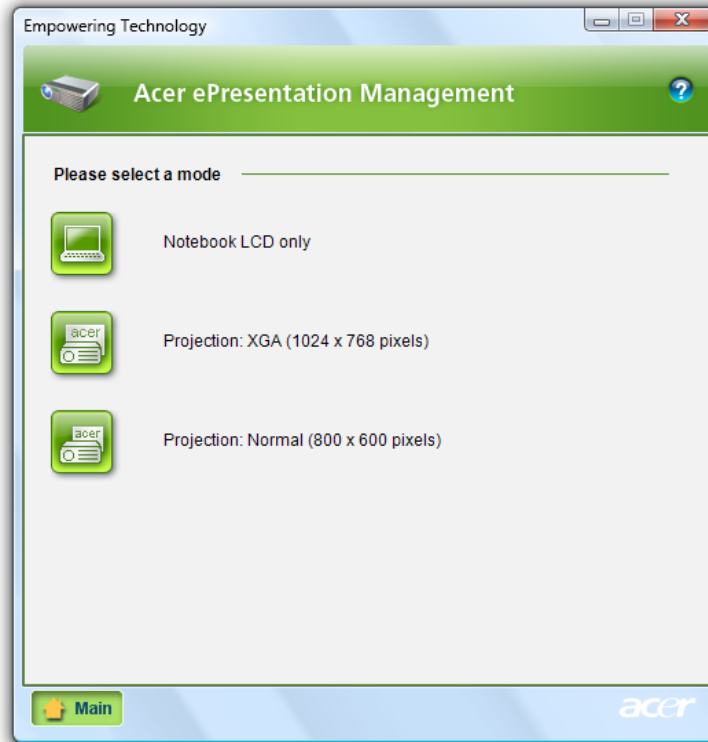

**NOTE:** If the restored resolution is not correct after disconnecting a projector, or you need to use an external resolution that is not supported by Acer ePresentation Management, adjust your display settings using Display Properties or the utility provided by the graphics vendor.



# Acer eDataSecurity Management (for selected models)

Acer eDataSecurity Management is an encryption utility that protects your files from being accessed by unauthorized persons. It is conveniently integrated with Windows Explorer as a shell extension for quick data encryption/decryption and also supports on-the-fly file encryption for Lotus Notes and Microsoft Outlook.

The Acer eDataSecurity Management setup wizard will prompt you for a supervisor password and default encryption password. This password will be used to encrypt files by default, or you can choose to enter your own password when encrypting a file.



**NOTE:** The password used to encrypt a file is the unique key that the system needs to decrypt it. If you lose the password, the supervisor password is the only other key capable of decrypting the file. If you lose both passwords, there will be no way to decrypt your encrypted file! **Be sure to safeguard all related passwords!**



# Acer eLock Management

Acer eLock Management is simple yet effective utility that allows you to lock removable storage, optical and floppy drive devices to ensure that data can't be stolen while your system is unattended.

- Removable Storage Devices — includes USB disk drives, USB pen drives, USB flash drives, USB MP3 drives, USB memory card readers, IEEE 1394 disk drives, and any other removable storage devices that can be mounted as a file system when plugged into the system.
- Optical Drive Devices — includes any kind of CD-ROM, DVD-ROM, HD-DVD or Blu-ray drive devices.
- Floppy Drive Devices — 3.5-inch floppy drives only.

To use Acer eLock Management, the Empowering Technology password must be set first. Once set, you can apply locks to any of the devices types. Lock(s) will immediately be set without any reboot necessary, and will remain after rebooting, until removed.

**NOTE:** If you lose the Empowering Technology password, there is no method to reset it except by reformatting your system. Make sure to remember or write down your password.

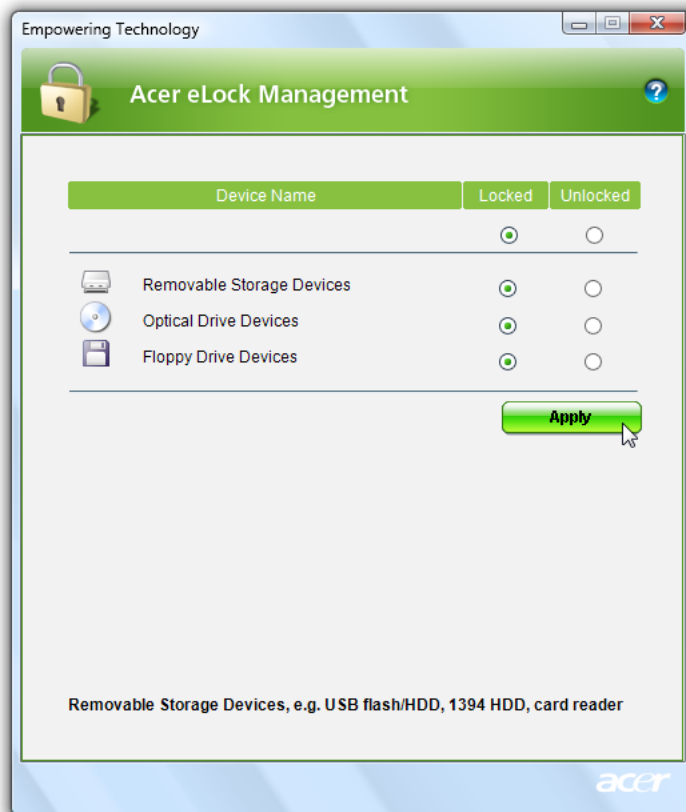

# Acer eRecovery Management

Acer eRecovery Management is a versatile backup utility. It allows you to create full or incremental backups, burn the factory default image to optical disc, and restore from previously created backups or reinstall applications and drivers. By default, user-created backups are stored to the D:\ drive.

Acer eRecovery Management provides you with:

- Password protection (Empowering Technology password)
- Full and incremental backups to hard disk or optical disc
- Creation of backups:
  - Factory default image
  - User backup image
  - Current system configuration
  - Application backup
- Restore and recovery:
  - Factory default image
  - User backup image
  - From previously-created CD/DVD
  - Reinstall applications/drivers

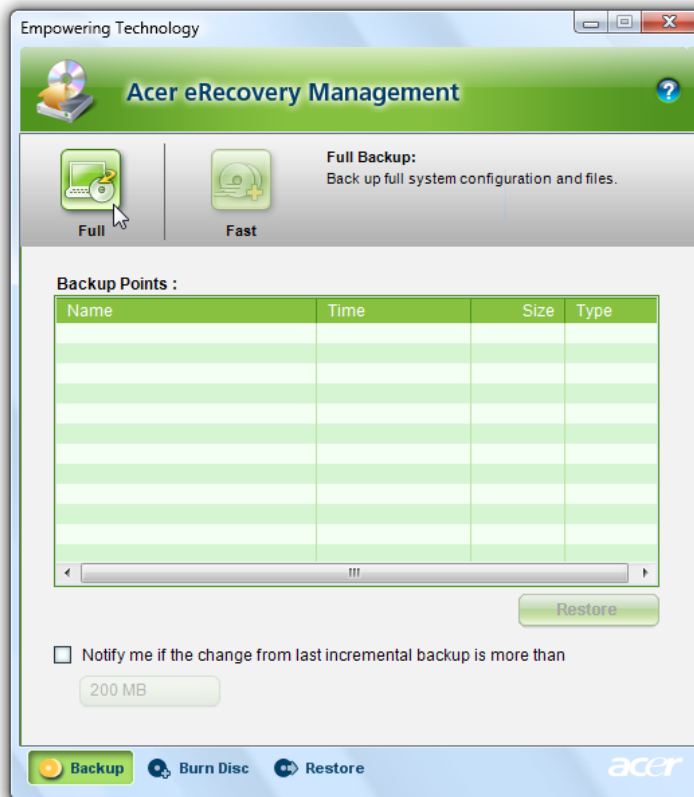

**NOTE:** If your computer did not come with a Recovery CD or System CD, please use Acer eRecovery Management's "System backup to optical disc" feature to burn a backup image to CD or DVD. To ensure the best results when recovering your system using a CD or Acer eRecovery Management, detach all peripherals (except the external Acer ODD, if your computer has one), including your Acer ezDock.

# Acer eSettings Management

Acer eSettings Management allows you to inspect hardware specifications, set BIOS passwords and modify boot options.

Acer eSettings Management also:

- Provides a simple graphical user interface for navigation.
- Prints and saves hardware specifications.
- Lets you set an asset tag for your system.

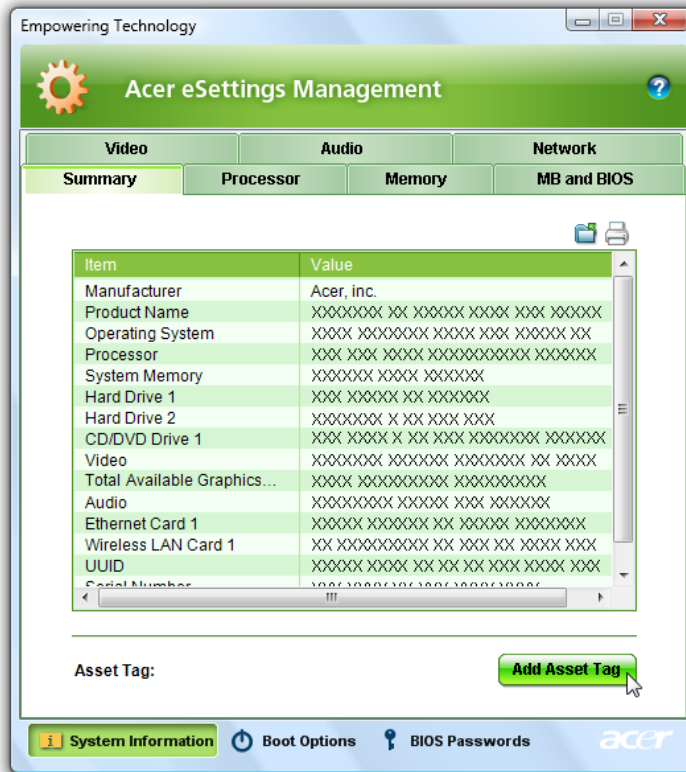

---

# Windows Mobility Center



The Windows Mobility Center collects key mobile-related system settings in one easy-to-find place, so you can quickly configure your Acer system to fit the situation as you change locations, networks or activities. Settings include display brightness, power plan, volume, wireless networking on/off, external display settings, display orientation and synchronization status.

Windows Mobility Center also includes Acer-specific settings like Bluetooth Add Device (if applicable), sharing folders overview/sharing service on or off, and a shortcut to the Acer user guide, drivers and utilities.

To launch Windows Mobility Center:

- Use the shortcut key  $\langle \text{Windows Logo} \rangle + \langle X \rangle$
- Start Windows Mobility Center from the Control panel
- Start Windows Mobility Center from the Accessories program group in the Start menu.

# Using the System Utilities

Acer Bio-Protection (only for certain models) Acer Bio-Protection Fingerprint Solution is a multi-purpose fingerprint software package integrated with the Microsoft Windows operating system. Utilizing the uniqueness of one's fingerprint features, Acer Bio-Protection Fingerprint Solution has incorporated protection against unauthorized access to your computer with centralized password management with Password Bank, easy music player launching with Acer MusicLaunch, secure Internet favorites via Acer MyLaunch, and fast application/website launching and login with Acer FingerLaunch, while Acer ProfileLaunch can launch up to three applications/websites from a single finger swipe.

Acer Bio-Protection Fingerprint Solution also allows you to navigate through web browsers and documents using Acer FingerNav. With Acer Bio-Protection Fingerprint Solution, you can now enjoy an extra layer of protection for your personal computer, as well as the convenience of accessing your daily tasks with a simple swipe of your finger!

For more information refer to the Acer Bio-Protection help files.



## Acer GridVista (dual-display compatible)

**NOTE:** This feature is only available on certain models.

To enable the dual monitor feature of the notebook, first ensure that the second monitor is connected, then select **Start, Control Panel, Display** and click on **Settings**. Select the secondary monitor (**2**) icon in the display box and then click the check box **Extend my windows desktop onto this monitor**. Finally, click **Apply** to confirm the new settings and click **OK** to complete the process.



Acer GridVista is a handy utility that offers four pre-defined display settings so you can view multiple windows on the same screen. To access this function, please go to **Start → All Programs** and click on **Acer GridVista**. You may choose any one of the four display settings indicated below:



Double (vertical), Triple (primary at left), Triple (primary at right), or Quad Acer Gridvista is dual-display compatible, allowing two displays to be partitioned independently.

Acer Gridvista is dual-display compatible, allowing two displays to be partitioned independently.

AcerGridVista is simple to set up:

1. Run Acer GridVista and select your preferred screen configuration for each display from the task bar.
2. Drag and drop each window into the appropriate grid.
3. Enjoy the convenience of a well-organized desktop.

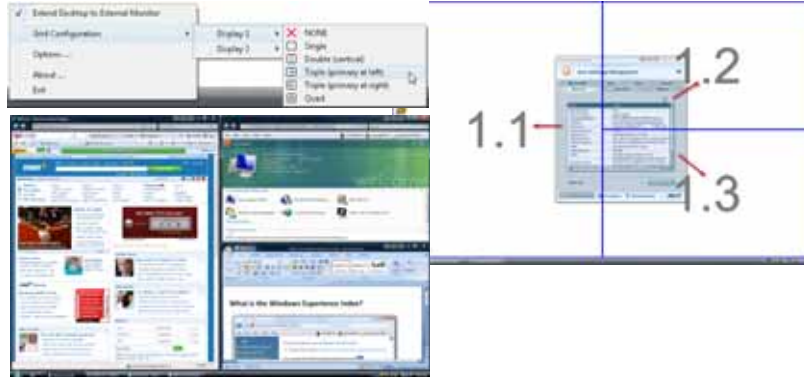

**NOTE:** Please ensure that the resolution setting of the second monitor is set to the manufacturer's recommended value.

## Launch Manager



Launch Manager allows you to set the four easy-launch buttons located above the keyboard. You can access the Launch Manager by clicking on Start > All Programs > Launch Manager to start the application.

---

# Norton Internet Security

Norton Internet Security is an anti-virus utility that can protect against viruses, keeping your data safe and secure.

## How do I check for viruses?

1. Double-click the **Norton Internet Security** icon on the Windows desktop.
2. Select **Tasks & Scans**.
3. Select **Run Scan** to scan your system.



4. When the scan is complete, review the results of the scan.

**NOTE:** For optimal security, run a Full System Scan when scanning your computer for the first time.

You can schedule customized virus scans that run unattended on specific dates and times or at periodic intervals. If you are using the computer when the scheduled scan begins, it runs in the background so that you do not have to stop working.

For more information refer to the Norton Internet Security help files.



# Hardware Specifications and Configurations

## Processor

Item	Specification
CPU type	Intel® Core™2 Duo mobile processor, supporting Intel® 64 architecture
Core logic	Mobile Intel® GM45/PM45 + ICH9M
CPU package	Socket M (FCPGA6)
CPU core voltage	1.0375V to 1.3V

## CPU Fan True Value Table

CPU Temperature		Fan Speed (rpm)	SPL Spec (dBA)
Core 0	Core 1		
58	58	2500	29
66	66	3000	31
74	74	3400	34
85	85	3800	37
100	100	4200	40

- Throttling 50%: On= 100°C; OFF=90°C
- OS shut down at 105°C; H/W shut down at 96°C

## BIOS

Item	Specification
BIOS vendor	Insyde
BIOS Version	1.00 (MP version)
BIOS ROM type	Macronix_MX25L8005/ EON_EN25F80
BIOS ROM size	1M bytes
BIOS package	SPI Flash part
Supported protocols	ACPI 1.0b/2.0/3.0 PCI 2.2 or later System/HDD Password Security Control INT 13h Extensions PnP BIOS 1.0a SMBIOS 2.4 or later. BIOS Boot Specification (Compal, Phoenix, Intel) Simple Boot Flag 1.0 Boot Block PCI Bus Power Management Interface Specification USB Specification 1.1/2.0 USB Boot Up support Support HD audio WfM 2.0 Preboot Execution Environment (PXE) 2.1 Boot Integrity Service Application Program Interface (BIS) 1.0. PC2002/2005 compliant Intel Enhanced SpeedStep Technology AHCI support.
BIOS password control	Set by setup manual

## Cache

Item	Specification
Cache controller	Built-in CPU
Cache size	Up to 6-MB second-level shared cache (See CPU type)

## System Memory

Item	Specification
Memory controller	Built-in
Memory size	0MB (no on-board memory)
DIMM socket number	2 sockets
Supports memory size per socket	2 GB
Supports maximum memory size	4G for 64bit OS (with two 2GB SODIMM)
Supports DIMM type	DDR 2 Synchronous DRAM
Supports DIMM Speed	667/800 MHz
Supports DIMM voltage	1.8V and 0.9V
Supports DIMM package	200-pin soDIMM
Memory module combinations	You can install memory modules in any combinations as long as they match the above specifications.

## Memory Combinations

Slot 1	Slot 2	Total Memory
0MB	256MB	256MB
0MB	512MB	512MB
0MB	1024MB	1024MB
0MB	2048MB	2048MB
256MB	256MB	512MB
256MB	512MB	768MB
256MB	1024MB	1280MB
256MB	2048MB	2304MB
512MB	256MB	768MB
512MB	512MB	1024MB
512MB	1024MB	1536MB
512MB	2048MB	2560MB
1024MB	0MB	1024MB
1024MB	256MB	1280MB
1024MB	512MB	1536MB
1024MB	1024MB	2048MB
1024MB	2048MB	3072MB
2048MB	0MB	2048MB
2048MB	256MB	2304MB
2048MB	512MB	2560MB
2048MB	1024MB	3072MB
2048MB	2048MB	4096MB

**NOTE:** Above table lists some system memory configurations. You may combine DIMMs with various capacities to form other combinations. On above table, the configuration of slot 1 and slot 2 could be reversed.

### LAN Interface

Item	Specification
LAN Chipset	Realtek RTL8111C-GR
Supports LAN protocol	10/100/1000 Mbps
LAN connector type	RJ45
LAN connector location	Left side
Features	PCI-E Giga LAN Support Wake-On-Lan (AC mode S5) No ASF 2.0/iAMT 4.0

### Bluetooth Interface

Item	Specification
Chipset	Broadcom 2045 & Broadcom 2070
Data throughput	723 bps (full speed data rate)
Protocol	Bluetooth 2.0
Interface	Mini USB module and built-in antenna
Connector type	Mini USB

### Wireless Module 802.11b/g

Item	Specification
Chipset	Intel Shirley Peak and Echo Peak (for Centrino platform) Atheros WLAN XB63 and Broadcom WLAN BCM4312 (for Non-Centrino)
Data throughput	11~54 Mbps, up to 270 Mbps for Draft-N
Protocol	802.11b+g, Draft-N
Interface	PCI bus (mini PCI socket for wireless module)

### Hard Disk Drive Interface

Item				
Vendor & Model Name	HGST 2.5" HTS542580K9SA00 BRONCO-B SATA II, WD 2.5" WD800BEVS-22RST0 ML80 SATA	HGST 2.5" HTS542512K9SA00 BRONCO-B SATA II	WD 2.5" WD1600BEVS-22RST0 ML80 SATA, HGST 2.5" HTS542516K9SA00 BRONCO-B SATA II	HGST 2.5" HTS542525K9SA00 BRONCO-B SATA II, WD 2.5" WD2500BEVS-22UST0 ML80 SATA
Capacity (MB)	80000	120000	160000	250000
Bytes per sector	512	512	512	512
Data heads	2	3	3/4	4
Drive Format				
Disks	1	2	2	2
Spindle speed (RPM)	5400 RPM	5400 RPM	5400 RPM	5400 RPM
Performance Specifications				
Buffer size	8MB	8MB	8MB	8MB
Interface	SATA	SATA	SATA	SATA

Item				
Max. media transfer rate (disk-buffer, Mbytes/s)	540	540	540	540
Data transfer rate (host~buffer, Mbytes/s)	100 MB/Sec. Ultra DMA mode-5	150 MB/Sec. Ultra DMA mode-5	150 MB/Sec. Ultra DMA mode-5	150 MB/Sec. Ultra DMA mode-5
<b>DC Power Requirements</b>				
Voltage tolerance	5V(DC) +/- 5%	5V(DC) +/- 5%	5V(DC) +/- 5%	5V(DC) +/- 5%

### Combo Drive Module

Item	Specification
Vendor & model name	PLDS Corp./DS-8A2S, Pioneer/DVR-TD08RS, Hitachi/GSA-T50N, Acer/UJ870ABAA-A, Sony/BC-5500S-AR, Toshiba/TS-L633A
Performance Specification	With CD Diskette   With DVD Diskette
Transfer rate (KB/sec)	Sustained: Max 3.6Mbytes/sec   Sustained: Max 10.8Mbytes/sec
Buffer Memory	2MB
Interface	SATA
Applicable disc format	Applicable media types: CD-ROM, CD-R and CD-RW DVD-ROM (4.7G/8.54G) single layer on single/double side (Read Only), DVD-ROM dual layer (PTP/OTP) on single/double side, (Read Only) DVD-R (3.9G, 4.7G for General and Authoring), DVD-RW, DVD+RW (4.7G), DVD+R, DVD+R DL, DVD-R DL DVD-RAM CD-DA, CD-TEXT, CD ROM Mode-1, CD-ROM/XA Mode-2 Form-1 and Form-2, CD-I Ready, Video-CD (MPEG-1), Photo-CD, Enhance CD, CD extra, I-Trax CD and UDF DVD-ROM, DVD-Video, DVD-Audio, DVD-R single/multi border(s) DVD+R single/multi session(s) DVD-RW DVD+RW DVD-RAM
Loading mechanism	Drawer (Solenoid Open) Tact SW (Open) Emergency Release (draw open hole)
<b>Power Requirement</b>	
Input Voltage	DC 5 V +/- 0.25V

### Audio Interface

Item	Specification
Audio Controller	Realtek ALC888S-VC
Audio onboard or optional	Built-in
Mono or Stereo	Stereo
Resolution	True 5.1
Compatibility	Headphone-out/Line-out/SPDIF-out: UAA Supports Dolby Home Theater
Sampling rate	1Hz resolution VSR (Variable Sampling Rate)
Internal microphone	Mic Array (ForteMedia, Digital Mic type)
Internal speaker / Quantity	2.0 Watt speaker/10cc chamber/speaker size 18 phi, x2

### Video Memory

Item	Specification
Chipset	UMA NB9PGE2-256MB-GDDR3/NB9MGS-256MB-GDDR2
Memory size	256 MB

### USB Interface

Item	Specification
Chipset	ICH9M
USB Compliancy Level	2.0
OHCI	USB 1.1 and USB 2.0 Host controller
Number of USB port	3
Location	Two on the left side/one on the right side
Serial port function control	Enable/Disable by BIOS Setup

### System Board Major Chips

Item	Controller
Core logic	Intel® Cantiga (GM-45 & PM-45)/ICH9M Express Chipset
VGA	UMA
LAN	Realtek RTL8111C-GR
USB 2.0	Intel ICH9M
Super I/O controller	N/A
MODEM	Foxconn/LSI AM5 V2 1.5_3.3V
Bluetooth	Broadcom 2045 & Broadcom 2070
Wireless 802.11 b+g	Atheros WLAN XB63 and Broadcom WLAN BCM4312
Audio Codec	Realtek ALC888S-VC

### Keyboard

Item	Specification
Keyboard controller	LPC interface
Total number of keypads	88-/89-/93-key
Windows logo key	Yes
Internal & external keyboard work simultaneously	Plug USB keyboard to the USB port directly: Yes

**Battery**

Item	Specification
Vendor & model name	Sanyo AS07A Sony AS07A Simplo AS07A Panasonic AS07A
Battery Type	Li-ion
Pack capacity	4400 mAh
Number of battery cell	6
Package configuration	3 cells in series, 2 series in parallel
Normal voltage	11.1V (Panasonic 10.8V)
Charge voltage	12.6V

**LCD 14.1"**

Item	Specification
Vendor/model name	LG.Philips/LP141WX3, AUO/B141EW04 V4, Chimei/N141I3 - L02, Samsung/LTN141W3-L01
Screen Diagonal (mm)	14.1 inches
Active Area (mm)	303.74 x 189.84 mm
Display resolution (pixels)	1280 x 800 WXGA
Pixel Pitch	0.2373 x 0.2373 mm
Pixel Arrangement	R.G.B. Vertical Stripe
Display Mode	Transmissive mode, normally white
Typical White Luminance (cd/m <sup>2</sup> ) also called Brightness	200 cd/m <sup>2</sup> (Typ.5 point)
Luminance Uniformity	1.3 max.
Contrast Ratio	300 minimum
Response Time (Optical Rise Time/Fall Time) msec	16
Nominal Input Voltage VDD	+3.3V
Typical Power Consumption (watt)	1.4W max.
Weight (without inverter)	400g max.
Physical Size (mm)	319.5 (±0.5) x 205.5 (± 0.5) x 5.5 max.
Electrical Interface	3.3V LVDS interface with 1 pixel/clock
Support Color	greater than 262144
Viewing Angle (degree) Horizontal: Right/Left Vertical: Upper/Lower	Minimum: 40/40, Typical: 45/45 Minimum: 10/30, Typical: 20/35
Temperature Range (°C) Operating Storage (shipping)	0 to +50 -20 to +60

**LCD Inverter**

Item	Specification
Vendor & model name	YEC YNV-C01H
Brightness conditions	N/A
Input voltage (V)	9~20(V)
Input current (mA)	Typical 0.33(mA)
Output voltage (V, rms)	Typical 650 Vrms
Output current (mA, rms)	MAX. 6.8mA
Output voltage frequency (k Hz)	45~65 (KHz)

**AC Adapter**

Item	Specification
Input rating	100~240Vac/ 50-60Hz
Maximum input AC current	1.5A
Inrush current	No damage
Efficiency	Meet EPA level-4 requirement

**System Power Management**

ACPI mode	Power Management
Mech. Off (G3)	All devices in the system are turned off completely.
Soft Off (G2/S5)	OS initiated shutdown. All devices in the system are turned off completely.
Working (G0/S0)	Individual devices such as the CPU and hard disk may be power managed in this state.
Suspend to RAM (S3)	CPU set power down VGA Suspend PCMCIA Suspend Audio Power Down Hard Disk Power Down CD-ROM Power Down Super I/O Low Power mode
Save to Disk (S4)	Also called Hibernation Mode. System saves all system states and data onto the disc prior to power off the whole system.





# System Utilities

---

## BIOS Setup Utility

The BIOS Setup Utility is a hardware configuration program built into your computer's BIOS (Basic Input/Output System).

Your computer is already properly configured and optimized, and you do not need to run this utility. However, if you encounter configuration problems, you may need to run Setup. Please also refer to Chapter 4 Troubleshooting when problem arises.

To activate the BIOS Utility, press **F2** during POST (when "Press <F2> to enter Setup" message is prompted on the bottom of screen).

Press **F2** to enter setup. The default parameter of F12 Boot Menu is set to "disabled". If you want to change boot device without entering BIOS Setup Utility, please set the parameter to "enabled".

Press <F12> during POST to enter multi-boot menu. In this menu, user can change boot device without entering BIOS SETUP Utility.

## Navigating the BIOS Utility

There are six menu options: Information, Main, Advanced, Security, Boot, and Exit.

Follow these instructions:

- To choose a menu, use the left and right arrow keys.
- To choose an item, use the up and down arrow keys.
- To change the value of a parameter, press **F5** or **F6**.
- A plus sign (+) indicates the item has sub-items. Press **Enter** to expand this item.
- Press **Esc** while you are in any of the menu options to go to the Exit menu.
- In any menu, you can load default settings by pressing **F9**. You can also press **F10** to save any changes made and exit the BIOS Setup Utility.

**NOTE:** You can change the value of a parameter if it is enclosed in square brackets. Navigation keys for a particular menu are shown on the bottom of the screen. Help for parameters are found in the Item Specific Help part of the screen. Read this carefully when making changes to parameter values. **Please note that system information is subject to different models.**

# Information

The Information screen displays a summary of your computer hardware information.

InsydeH20 Setup Utility						Rev. 3.5
Information	Main	Advanced	Security	Power	Boot	Exit
CPU Type:	Intel (R) Core (TM)2 Duo CPU @ 2.40GHz					
CPU Speed:	2.40GHz					
HDD Model Name:	Hitachi HTS543516K9SA00					
HDD Serial Number:	071129BB0C02WGHDKKGC					
ATAPI Model Name:	Slimtype DVD A DS8A2S					
System BIOS Version:	V0.15T2					
VGA BIOS Version:	Intel V1588					
Serial Number:						
Asset Tag Number:						
Product Name:	Aspire 4930					
Manufacturer Name:	Acer					
UUID:	864BD4BE-6B22-5843-38D2-001B38D637FC					
F1 Help	↑↓ Select Item	F5/F6 Change Item	F9 Setup Default			
ESC Exit	←→ Select Menu	Enter Select▶ Submenu	F10 Save and Exit			

**NOTE:** The system information is subject to different models.

Parameter	Description
CPU Type	This field shows the CPU type and speed of the system.
CPU Speed	This field shows the speed of the CPU.
HDD Model Name	This field shows the model name of HDD installed on primary IDE master.
HDD Serial Number	This field displays the serial number of HDD installed on primary IDE master.
ATAPI Model Name	This field shows the model name of the Optical device installed in the system.
System BIOS Version	Displays system BIOS version.
VGA BIOS Version	This field displays the VGA firmware version of the system.
Serial Number	This field displays the serial number of this unit.
Asset Tag Number	This field displays the asset tag number of the system.
Product Name	This field shows product name of the system.
Manufacturer Name	This field displays the manufacturer of this system.
UUID Number	Universally Unique Identifier (UUID) is an identifier standard used in software construction, standardized by the Open Software Foundation (OSF) as part of the Distributed Computing Environment (DCE).

# Main

The Main screen allows the user to set the system time and date as well as enable and disable boot option and recovery.

InsydeH20 Setup Utility						Rev. 3.5
Information	Main	Advanced	Security	Power	Boot	Exit
System Time			[13:04:04]			Item Specific Help
System Date			[04/21/2008]			This is the help for the hour field. Valid range is from 0 to 23. INCREASE/REDUCE : F5/F6
Total Memory			3017 MB			
Video Memory			[32MB]			
Quick Boot			[Enabled]			
Network Boot			[Enabled]			
F12 Boot Menu			[Disabled]			
D2D Recovery			[Enabled]			
SATA Mode			[ACHI]			
F1 Help	↑↓ Select Item		F5/F6 Change Item			F9 Setup Default
ESC Exit	←→ Select Menu		Enter Select▶ Submenu			F10 Save and Exit

**NOTE:** The screen above is for your reference only. Actual values may differ.

The table below describes the parameters in this screen. Settings in **boldface** are the default and suggested parameter settings.

Parameter	Description	Format/Option
System Time	Sets the system time. The hours are displayed with 24-hour format.	Format: HH:MM:SS (hour:minute:second)
System Date	Sets the system date.	Format MM/DD/YYYY (month/day/year)
System Memory	This field reports the memory size of the system. Memory size is fixed to 3071 MB.	N/A
Video Memory	Shows the video memory size. VGA Memory size=32 MB	N/A
Quick Boot	Allows startup to skip certain tests while booting, decreasing the time needed to boot the system.	Option: <b>Enabled</b> or Disabled
Network Boot	Enables, disables the system boot from LAN (remote server).	Option: <b>Enabled</b> or Disabled
F12 Boot Menu	Enables, disables Boot Menu during POST.	Option: <b>Disabled</b> or Enabled
D2D Recovery	Enables, disables D2D Recovery function. The function allows the user to create a hidden partition on hard disc drive to store operation system and restore the system to factory defaults.	Option: <b>Enabled</b> or Disabled
SATA Mode	Control the mode in which the SATA controller should operate.	Option: <b>AHCI Mode</b> or IDE Mode

**NOTE:** The sub-items under each device will not be shown if the device control is set to disable or auto. This is because the user is not allowed to control the settings in these cases.

# Advanced

The Advanced screen allows the user to configure the various advanced BIOS options.

**IMPORTANT:** Making incorrect settings to items on these pages may cause the system to malfunction. Unless you have experience adjusting these items, we recommend that you leave these settings at the default values. If making settings to items on these pages causes your system to malfunction or prevents the system from booting, open BIOS and choose Load Optimal Defaults in the Exit menu to boot up normally.

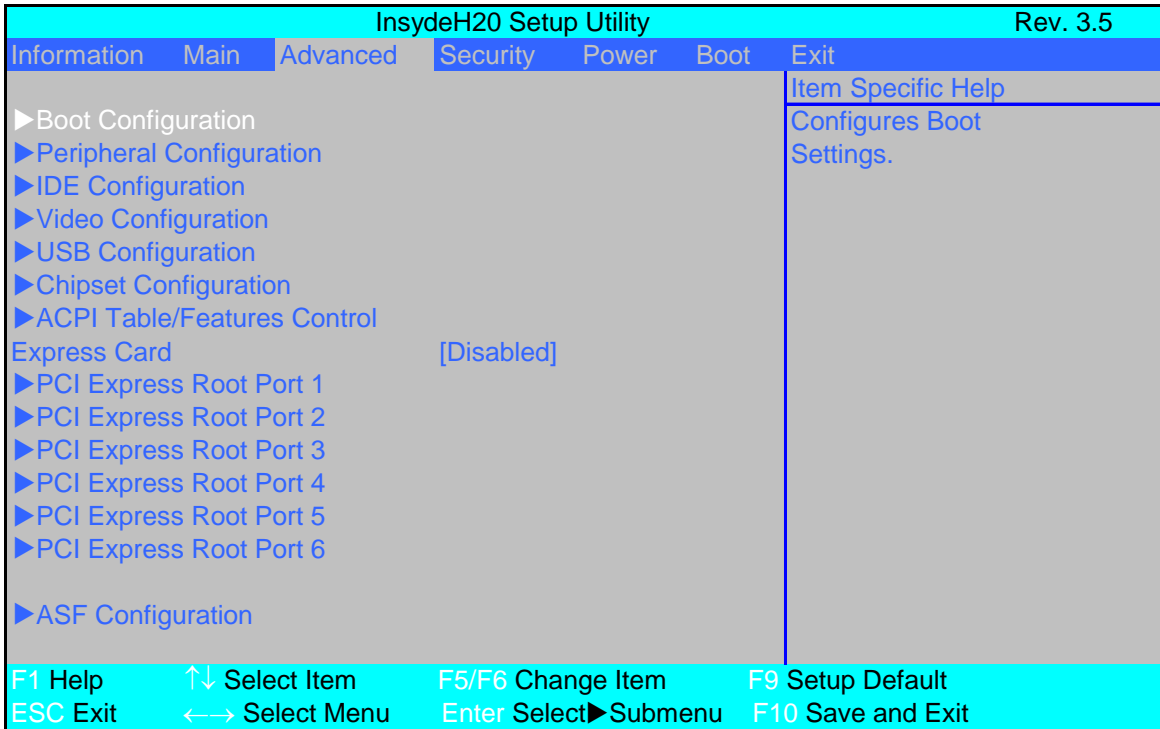

The table below describes the items, menus, and submenus in this screen. Settings in **boldface** are the default and suggested parameter settings.

Parameter	Description	Submenu Items
Boot Configuration	Enter the Boot Configuration menu.	<ul style="list-style-type: none"> <li>Numlock</li> <li>Zip Emulation Type</li> </ul>
Peripheral Configuration	Enter the Peripheral Configuration menu.	<ul style="list-style-type: none"> <li>Serial Port A</li> <li>Infrared Port</li> <li>Azalia</li> <li>LAN</li> </ul>
IDE Configuration	Enter the IDE Configuration menu.	<ul style="list-style-type: none"> <li>IDE Controller</li> <li>HDC Configure as</li> <li>ACHI Option ROM Support</li> <li>SATA Port 0, 1, 4, and 5 Hotplug</li> <li>Channel 1 to 4 Master and Slave</li> </ul>
Video Configuration	Enter the Video Configuration menu.	<ul style="list-style-type: none"> <li>IGD Device2, Function1</li> <li>IGD Pre-allocate Memory</li> <li>IGD DVMT Size</li> <li>Clock Chip Intialize</li> <li>Enabled CK SSC</li> <li>IGD Boot Type</li> <li>IGD LCD Panel Type</li> <li>IGD TV</li> </ul>

Parameter	Description	Submenu Items
USB Configuration	Enter the USB Configuration menu.	<ul style="list-style-type: none"> <li>• USB Driver Select</li> <li>• EHCI 1 and 2</li> <li>• UHCI 1 to 5</li> <li>• Per-Port Control</li> </ul>
Chipset Configuration	Enter the Chipset Configuration menu.	<ul style="list-style-type: none"> <li>• Port 80h Cycles</li> <li>• DMI Link ASPM Control</li> <li>• PCI Latency Timer</li> <li>• VT-d</li> </ul>
ACPI Table/ Features Control	Enter the ACPI Table/Features Control menu.	<ul style="list-style-type: none"> <li>• FACP C2 Latency Value</li> <li>• FACP C3 Latency Value</li> <li>• FACP RTC S4 Wakeup</li> <li>• APIC IO APIC Mode</li> <li>• HPET Support</li> <li>• Base Address Select</li> </ul>
Express Card	<b>Disable</b> or Enable the Express Card solution for windows Standby and Hibernation.	N/A
PCI Express Root Port 1 to 6	Enter the PCI Port 1 to 6 configuration menus.	<ul style="list-style-type: none"> <li>• VC1 Enable</li> <li>• ASPM</li> <li>• URR</li> <li>• FER</li> <li>• NFER</li> <li>• CER</li> <li>• CTO</li> <li>• SEFE</li> <li>• SENFE</li> <li>• SECE</li> <li>• PME Interrupt</li> <li>• PME SCI</li> <li>• Hot Plug SCI</li> </ul>
ASF Configuration	Enter the ASF Configuration menu.	<ul style="list-style-type: none"> <li>• Mini Watchdog Timeout</li> <li>• BIOS Boot Timeout</li> <li>• OS Boot Timeout</li> <li>• Power-on wait time</li> </ul>

# Security

The Security screen contains parameters that help safeguard and protect your computer from unauthorized use.

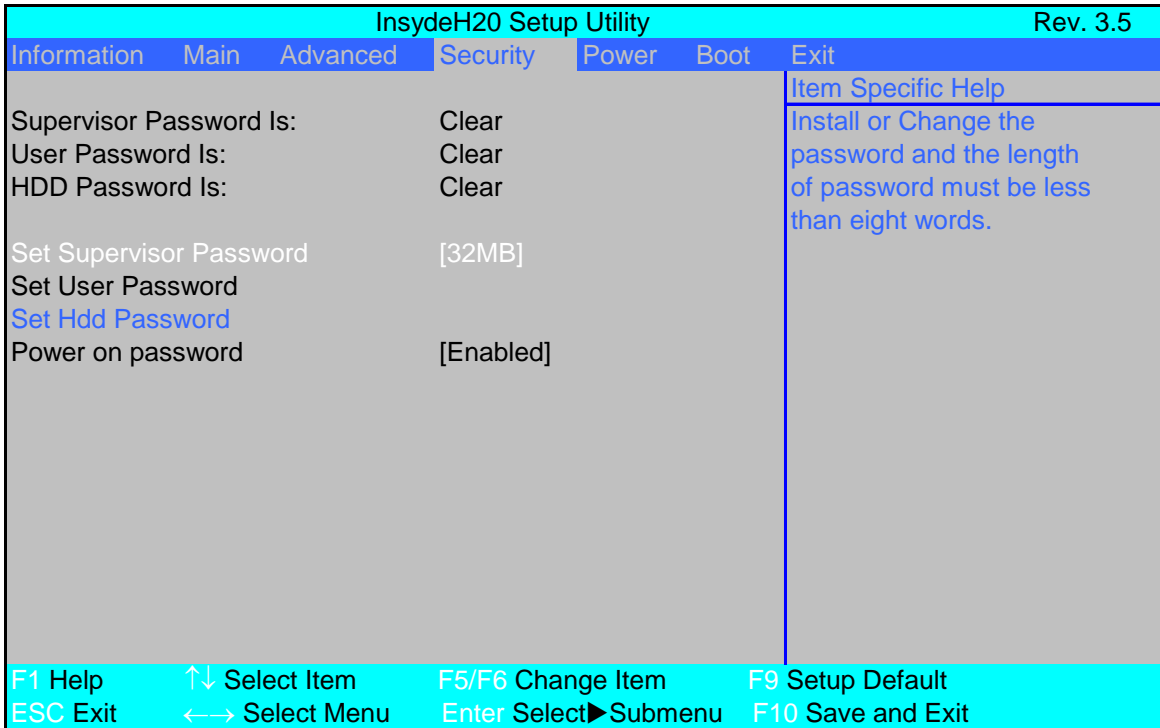

The table below describes the parameters in this screen. Settings in **boldface** are the default and suggested parameter settings.

Parameter	Description	Option
Supervisor Password Is	Shows the setting of the Supervisor password	<b>Clear</b> or Set
User Password Is	Shows the setting of the user password.	<b>Clear</b> or Set
HDD Password Is	Shows the setting of the hard disk password.	<b>Clear</b> or Set
Set Supervisor Password	Press Enter to set the supervisor password. When set, this password protects the BIOS Setup Utility from unauthorized access. The user can not either enter the Setup menu nor change the value of parameters.	
Set User Password	Press Enter to set the user password. When user password is set, this password protects the BIOS Setup Utility from unauthorized access. The user can enter Setup menu only and does not have right to change the value of parameters.	
Set HDD Password	Enter HDD Password.	
Password on Boot	Defines whether a password is required or not while the events defined in this group happened. The following sub-options are all requires the Supervisor password for changes and should be grayed out if the user password was used to enter setup.	<b>Disabled</b> or Enabled

**NOTE:** When you are prompted to enter a password, you have three tries before the system halts. Don't forget your password. If you forget your password, you may have to return your notebook computer to your dealer to reset it.

---

## Setting a Password

Follow these steps as you set the user or the supervisor password:

1. Use the ↑ and ↓ keys to highlight the Set Supervisor Password parameter and press the **Enter** key. The Set Supervisor Password box appears:

Set Supervisor Password		
Enter New Password	[	]
Confirm New Password	[	]

2. Type a password in the “Enter New Password” field. The password length can not exceeds 8 alphanumeric characters (A-Z, a-z, 0-9, not case sensitive). Retype the password in the “Confirm New Password” field.

**IMPORTANT:** Be very careful when typing your password because the characters do not appear on the screen.

3. Press **Enter**. After setting the password, the computer sets the User Password parameter to “Set”.
4. If desired, you can opt to enable the Password on boot parameter.
5. When you are done, press F10 to save the changes and exit the BIOS Setup Utility.

## Removing a Password

Follow these steps:

1. Use the w and y keys to highlight the Set Supervisor Password parameter and press the **Enter** key. The Set Password box appears:

Set Supervisor Password		
Enter current password	[	]
Enter New Password	[	]
Confirm New Password	[	]

2. Type the current password in the Enter Current Password field and press **Enter**.
3. Press e twice **without** typing anything in the Enter New Password and Confirm New Password fields. The computer then sets the Supervisor Password parameter to “Clear”.
4. When you have changed the settings, press u to save the changes and exit the BIOS Setup Utility.

---

## Changing a Password

1. Use the ↑ and ↓ keys to highlight the Set Supervisor Password parameter and press the **Enter** key. The Set Password box appears.

Set Supervisor Password		
Enter current password	[	]
Enter New Password	[	]
Confirm New Password	[	]

2. Type the current password in the Enter Current Password field and press **Enter**.
3. Type a password in the Enter New Password field. Retype the password in the Confirm New Password field.
4. Press **Enter**. After setting the password, the computer sets the User Password parameter to “Set”.
5. If desired, you can enable the Password on boot parameter.
6. When you are done, press F10 to save the changes and exit the BIOS Setup Utility.

If the verification is OK, the screen will display as following.

Setup Notice
Changes have been saved.
[ continue]

The password setting is complete after the user presses **Enter**.

If the current password entered does not match the actual current password, the screen will show you the Setup Warning.

Setup Warning
Invalid password
Re-enter Password
[ continue]

If the new password and confirm new password strings do not match, the screen will display the following message.

Setup Warning
Password do not match
Re-enter Password



# Power

The Power screen allows the user to configure various CPU and power management options and device wakeup behavior.

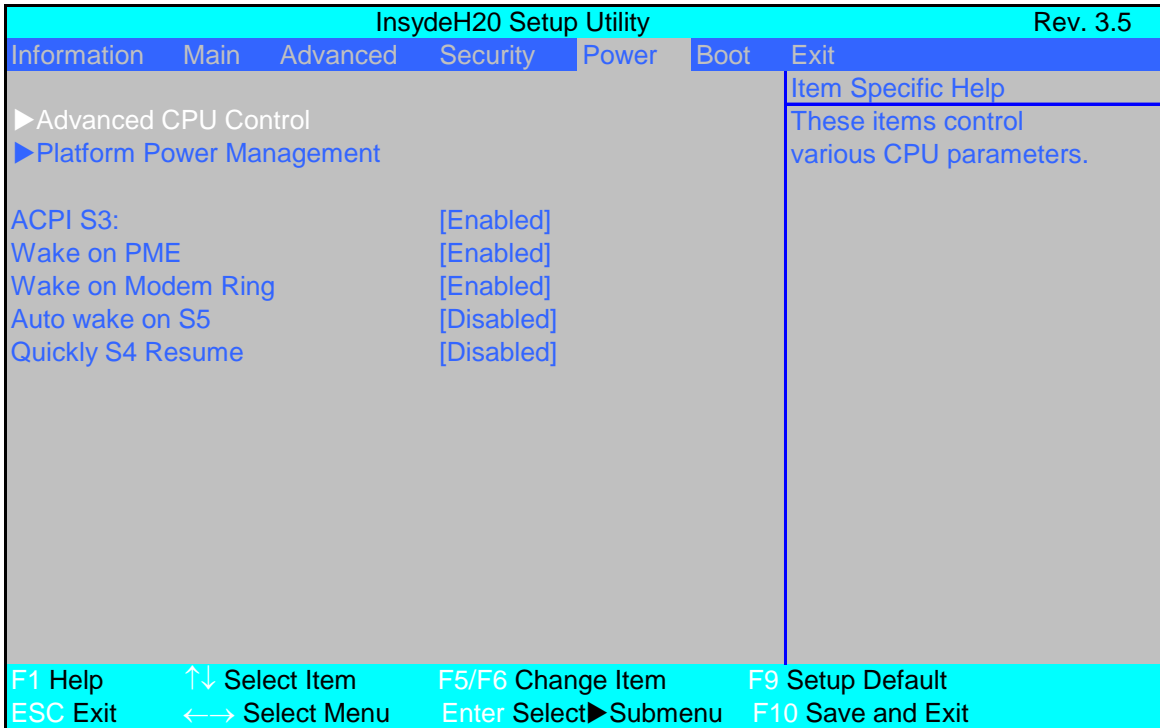

The table below describes the items, menus, and submenus in this screen. Settings in **boldface** are the default and suggested parameter settings.

Parameter	Description	Submenu Items
Advanced CPU Control	Enter the Advanced CPU Control menu.	<ul style="list-style-type: none"> <li>• P-States (IST)</li> <li>• Boot performance mode</li> <li>• Thermal Mode</li> <li>• CMP Support</li> <li>• Use XD capability</li> <li>• VT Support</li> <li>• C-States</li> <li>• Enhanced C-States</li> <li>• C-State Pop Up Mode</li> <li>• C-State Pop Down Mode</li> <li>• C4 Exit Timing Mode</li> <li>• DeepC4</li> <li>• Hard C4E</li> <li>• Enable C6</li> <li>• EMTTM</li> <li>• Bi-directional PROCHOT#</li> <li>• Dynamic FSB Switching</li> <li>• Turbo Mode</li> <li>• ACPI 3.0 T-States</li> <li>• DTS</li> <li>• DTS Calibration</li> <li>• Thermal Trip Points Setting (Fan On Temp., Throttle On Temp.)</li> </ul>

Parameter	Description	Submenu Items
Platform Power management	Enter the Platform Power Management menu.	<ul style="list-style-type: none"> <li>• PCI Clock Run</li> <li>• _CST - C4 Latency Value</li> <li>• C4 on C3 - Deeper Sleep</li> </ul>
ACPI S3	<b>Enable</b> or Disable ACPI S1/S3 Sleep State	N/A
Wake on PME	<b>Enable</b> or Disable wake up when the system power is off and a PCI Power Management Enable wake up event occurs.	N/A
Wake on Modem Ring	<b>Enable</b> or Disable wake up when the system power is off and a modem attached to the serial port is ringing.	N/A
Auto wake on S5	<b>Disable</b> or Enable auto wake up by date and time or at a fixed time everyday.	N/A
Quickly S4 Resume	Disable or Enable optional quick boot from S4 Resume.	N/A

# Boot

This menu allows the user to decide the order of boot devices to load the operating system. Bootable devices includes the USB diskette drives, the onboard hard disk drive and the DVD drive in the module bay.

InsydeH20 Setup Utility				Rev. 3.5		
Information	Main	Advanced	Security	Power	Boot	Exit
Boot priority order:						Item Specific Help
1. IDE0 : Hitachi HTS542516K9SA00						Use <↑> or <↓> to select a device, then press <F5> to move it down the list, or <F6> to move it up the list. Press <Esc> to escape the menu
2. IDE1 : Slimtype DVD A DS8A2S						
3 . USB FDD :						
4. Network Boot : Realtek Boot Agent						
5. USB HDD :						
6. USB CDROM :						
F1 Help	↑↓ Select Item	F5/F6 Change Item	F9 Setup Default			
ESC Exit	←→ Select Menu	Enter Select▶ Submenu	F10 Save and Exit			

# Exit

The Exit screen allows you to save or discard any changes you made and quit the BIOS Utility.

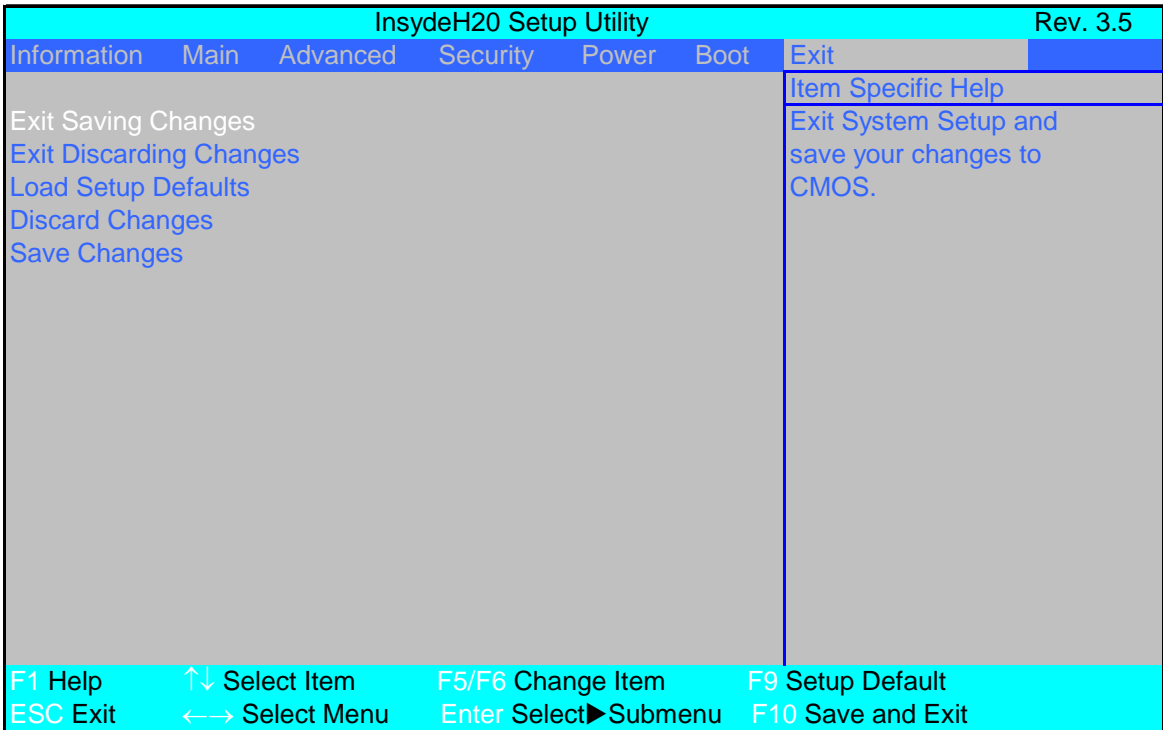

The table below describes the parameters in this screen.

Parameter	Description
Exit Saving Changes	Exit System Setup and save your changes to CMOS.
Exit Discarding Changes	Exit utility without saving setup data to CMOS.
Load Setup Default	Load default values for all SETUP item.
Discard Changes	Load previous values from CMOS for all SETUP items.
Save Changes	Save Setup Data to CMOS.

---

# BIOS Flash Utility

The BIOS flash memory update is required for the following conditions:

- New versions of system programs
- New features or options
- Restore a BIOS when it becomes corrupted.

Use the Phlash utility to update the system BIOS flash ROM.

**NOTE:** If you do not have a crisis recovery diskette at hand, then you should create a **Crisis Recovery Diskette** before you use the Phlash utility.

**NOTE:** Do not install memory-related drivers (XMS, EMS, DPMI) when you use the Phlash.

**NOTE:** Please use the AC adaptor power supply when you run the Phlash utility. If the battery pack does not contain enough power to finish BIOS flash, you may not boot the system because the BIOS is not completely loaded.

Follow the steps below to run the Phlash.

1. Prepare a bootable diskette.
2. Copy the flash utilities to the bootable diskette.
3. Then boot the system from the bootable diskette. The flash utility has auto-execution function.

# Remove HDD/BIOS Utility

This section provide you with removing HDD/BIOS method:

## Remove HDD Password:

- If you key in wrong HDD password for three time, “HDD password error code” would display on the screen. See the image below.

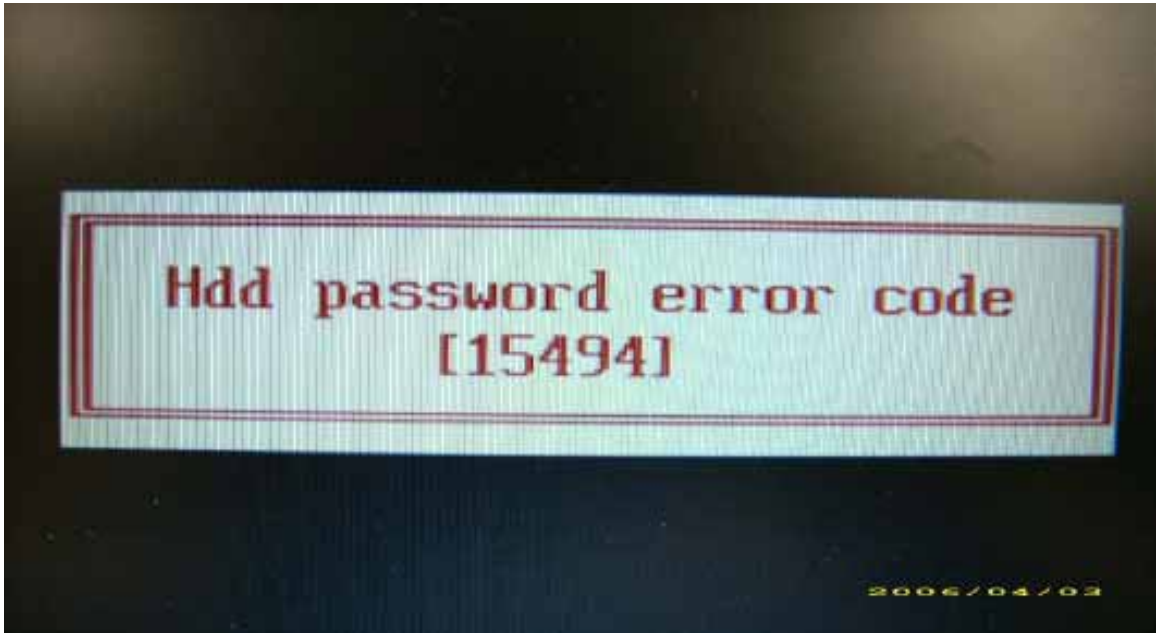

- If you need to solve HDD password locked problem, you can run HDD\_PW.EXE
  1. Key in “hdd\_pw 15494 0”
  2. Select “2”
  3. Choose one upper-case string



- Reboot system and key in “0KJFN42” or “UVEIQ96” to HDD user password.

Enter Primary Master HDD User Password [      ]

2006/04/03

### Remove BIOS Password:

- If you key in wrong Supervisor Password for three time, "System Disabled" would display on the screen. See the image below.

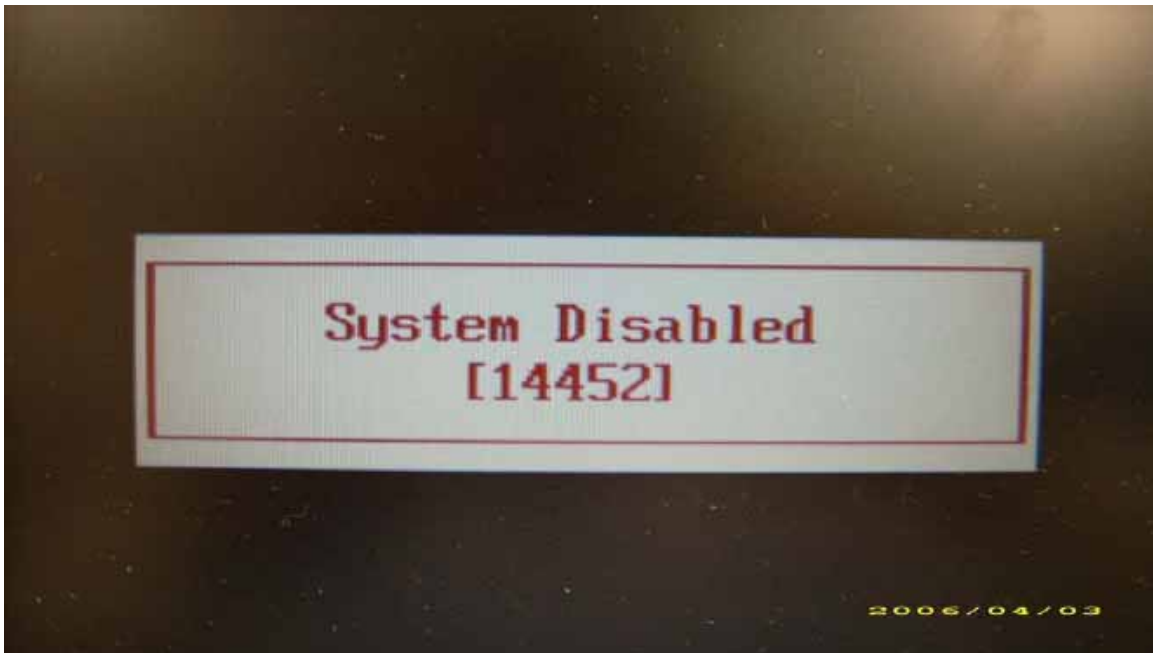

- If you need to solve BIOS password locked problem, you can run BIOS\_PW.EXE
  1. Key in "bios\_pw 14452 0"
  2. Choose one upper-case string



- Reboot the system and key in "qjjg9vy" or "07yqmjd" to BIOS user password.







# Machine Disassembly and Replacement

---

This chapter contains step-by-step procedures on how to disassemble the notebook computer for maintenance and troubleshooting.

## Disassembly Requirements

To disassemble the computer, you need the following tools:

- Wrist grounding strap and conductive mat for preventing electrostatic discharge
- Flat screwdriver
- Philips screwdriver
- Hex screwdriver
- Plastic flat screwdriver
- Plastic tweezers

**NOTE:** The screws for the different components vary in size. During the disassembly process, group the screws with the corresponding components to avoid mismatch when putting back the components.

# General Information

## Pre-disassembly Instructions

Before proceeding with the disassembly procedure, make sure that you do the following:

1. Turn off the power to the system and all peripherals.
2. Unplug the AC adapter and all power and signal cables from the system.



3. Place the system on a flat, stable surface.
4. Remove the battery pack.

## Disassembly Process

The disassembly process is divided into the following stages:

- External module disassembly
- Main unit disassembly
- LCD module disassembly

The flowcharts provided in the succeeding disassembly sections illustrate the entire disassembly sequence. Observe the order of the sequence to avoid damage to any of the hardware components. For example, if you want to remove the main board, you must first remove the keyboard, then disassemble the inside assembly frame in that order.

### Main Screw List

Screw	Quantity	Part Number
M2.5*8 (NL)	15	MA000005YG0
M2.5*5 (NL)	22	MA000007YG0
M2.5*3 (NL)	2	MA000005WG0
M2*3 (NL)	36	MA0000060G0
M2.5*4 (NL)	2	MA0000005G0
M2*6 (NL)	4	MMCK20060G0
M2*4-NI (NL)	5	MACK20040G0
M3*3 (NL)	4	MAAA03032G0
M2*6.5	4	MA0000096G0
M2.5*5.0	2	MA000002NG0
M2.5*6.5	4	MA000006C00

# External Module Disassembly Process

## External Modules Disassembly Flowchart

The flowchart below gives you a graphic representation on the entire disassembly sequence and instructs you on the components that need to be removed during servicing. For example, if you want to remove the main board, you must first remove the keyboard, then disassemble the inside assembly frame in that order.

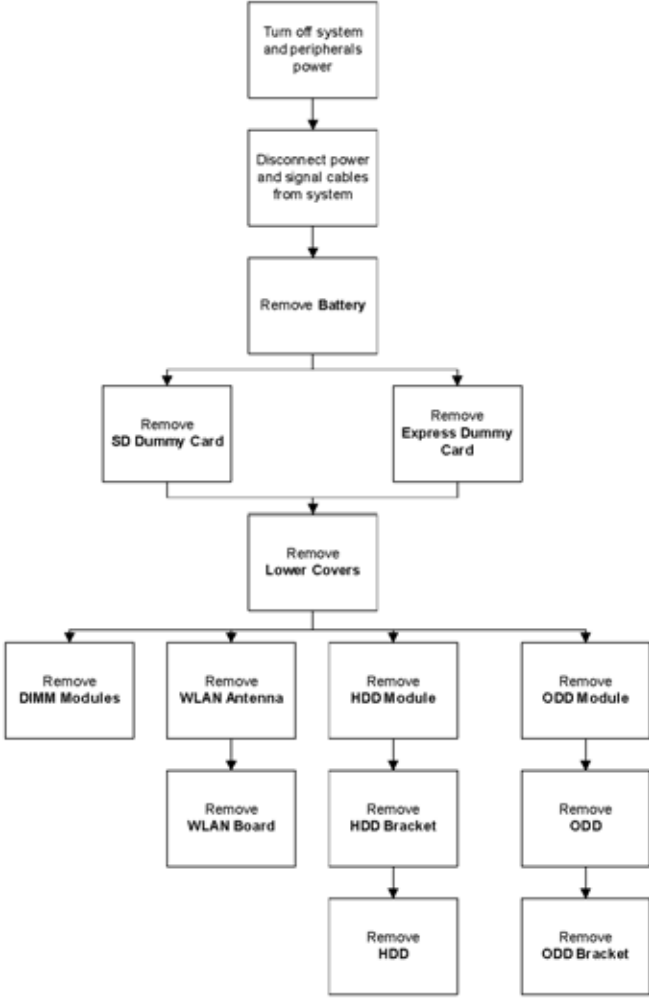

### Screw List

Item	Screw	Color	Part No.

---

## Removing the Battery Pack

1. Turn computer over.
2. Slide the battery lock/unlock latch to the unlock position.



3. Slide and hold the battery release latch to the release position (1), then slide out the battery pack from the main unit (2).



---

## Removing the SD dummy card

1. Push the SD dummy card all the way in to eject it (1, 2).



2. Pull it out from the slot.



---

## Removing the ExpressCard dummy card

1. Push the ExpressCard dummy card all the way in to eject it.



2. Pull it out from the slot.





## Removing the Lower Covers

1. See “Removing the Battery Pack” on page 60.
2. See “Removing the SD dummy card” on page 61.
3. See “Removing the ExpressCard dummy card” on page 62.
4. Remove the five screws from the memory, HDD, and WLAN bays.



Step	Size (Quantity)	Color	Torque
Memory Cover	M2.5*8 NL (2)	Black	
HDD Cover	M2*6 NL (2)	Black	
WLAN Cover	M2.5*8 NL (1)	Black	

5. Carefully open the memory cover.



- 
6. Remove the HDD cover as shown.



7. Remove the WLAN cover as shown.



---

## Removing the DIMM Module

1. See “Removing the Battery Pack” on page 60.
2. Remove the Memory Module cover See “Removing the Lower Covers” on page 63.
3. Push out the release latches on both sides of the DIMM socket to release the DIMM module.



4. Remove the DIMM module.



5. Repeat steps for the second DIMM module if present.

## Removing the WLAN Board Module

1. See “Removing the Battery Pack” on page 60.
2. Remove the WLAN cover. See “Removing the Lower Covers” on page 63.
3. Disconnect the antenna cables from the WLAN board.



4. Move the antenna away and remove the two screws (A) on the WLAN board to release the WLAN board.



Step	Size (Quantity)	Color	Torque
1~2	M2 x L3 (2)	Black	1.6 kgf-cm

- 
5. Detach the WLAN board from the WLAN socket.



**NOTE:** When attaching the antenna back to the WLAN board, make sure the cables are arranged properly.

---

## Removing the Hard Disk Drive Module

1. See “Removing the Battery Pack” on page 60.
2. Remove the HDD cover, See “Removing the Lower Covers” on page 63.
3. Use the mylar tab to slide and lift up the hard disk drive module to remove.



**NOTE:** To prevent damage to device, avoid pressing down on it or placing heavy objects on top of it.

4. Remove the four screws securing the hard disk to the carrier.

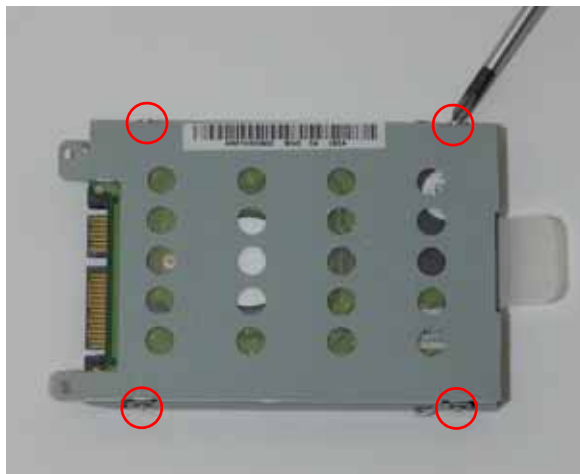

- 
5. Remove the HDD from the carrier.

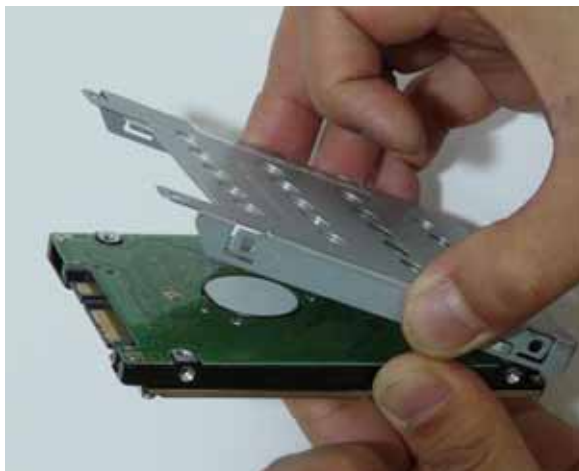

---

## Removing the Optical Drive Module

1. See “Removing the Battery Pack” on page 60.
2. Remove the Memory cover. See “Removing the Lower Covers” on page 63.
3. Remove the screw securing the ODD module.



4. Carefully use a plastic screw driver to release the locking catch.





5. Pull the optical drive module out from the main unit.



6. Remove the two screws (A) securing the ODD bracket and remove the ODD bracket from the optical disk drive module.



7. Insert a pin in the eject hole of the ODD to eject the ODD tray.

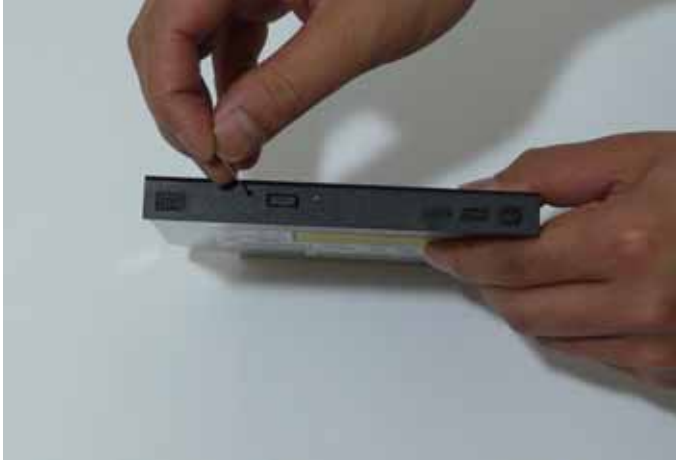

8. Press down on the locking catch to release the ODD cover, and remove.

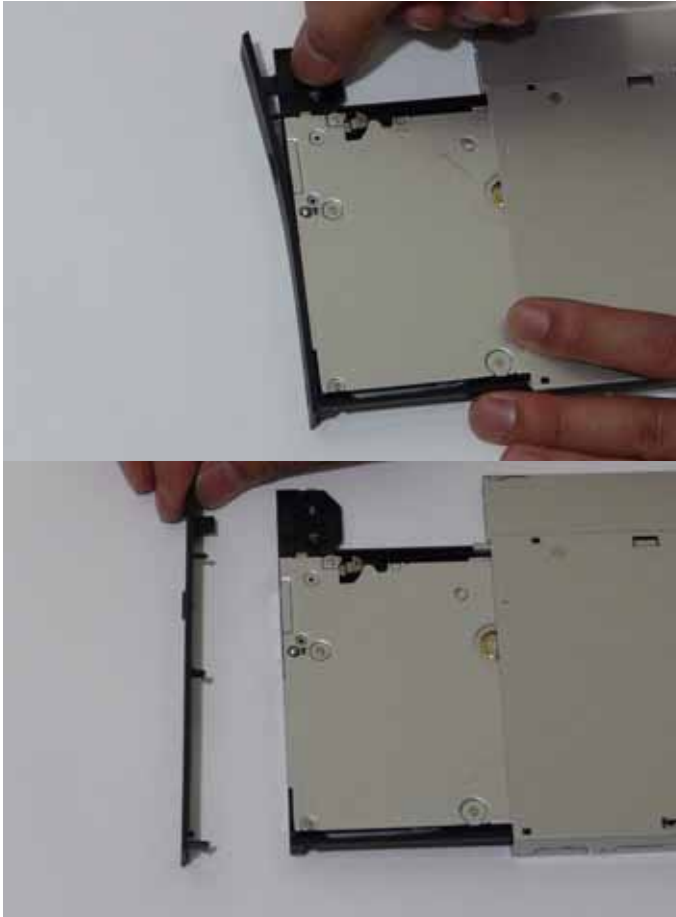

Step	Size (Quantity)	Color	Torque
1	M2.5 x L5 (1)	Black	
5	M2 x L4 (3)	Black	1.6 Kgf-cm

# Main Unit Disassembly Process

## Main Unit Disassembly Flowchart

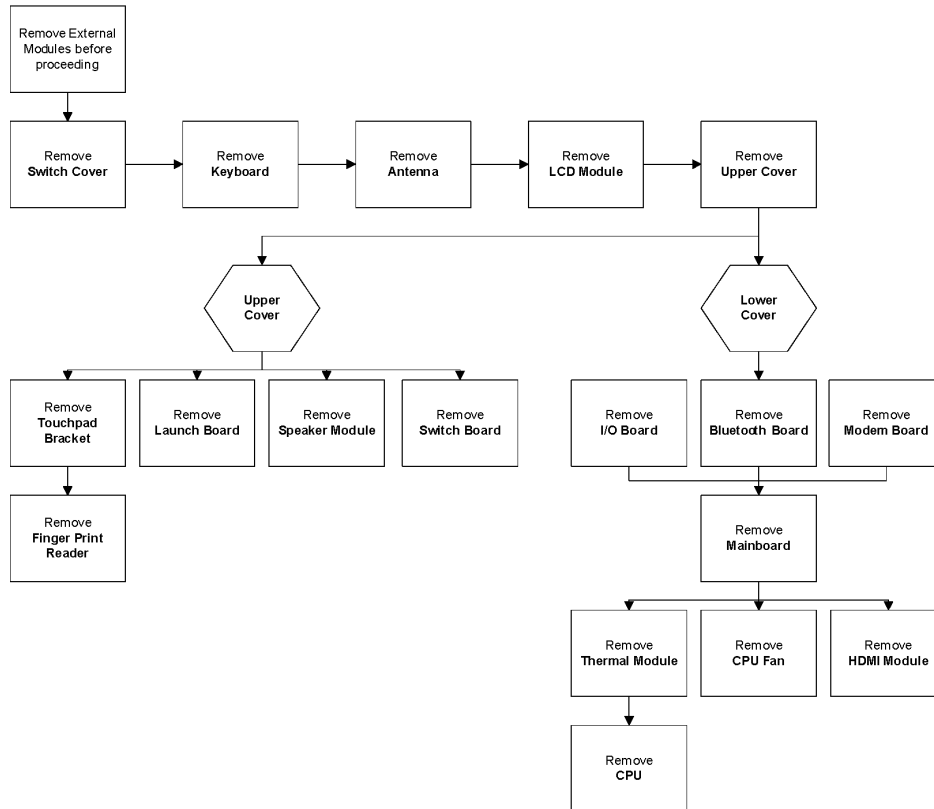

### Screw List

Item	Screw	Color	Part No.
A	M2 x L3	Black	86.00D29.620
D	M2 x L5	Black	86.00E32.725
F	M2 x L4	Black	86.00F24.724
H	M2.5 x L8	Black	86.00E34.738

# Removing the Switch Cover

**CAUTION:** Using tools to remove the Switch Cover may cause damage to the outer casing. It is recommended that only fingers are used to remove the Switch Cover.

1. See “Removing the Battery Pack” on page 60.
2. Locate and remove the two securing screws as shown.



Step	Size (Quantity)	Color	Torque
2	M2.5 x 5 (2)	Black	

3. Turn the computer over and open the LCD module fully to expose the Switch Cover.
4. Lift the Switch Cover as shown, leftside first.



- 
5. Turn the Switch Cover over to expose the interface cable and detach it using the tweezers.



6. Lift the Switch Cover clear of the chassis.

---

## Removing the Keyboard

1. See "Removing the Battery Pack" on page 60..
2. Push down on the two latches securing the keyboard to the upper case.



3. Lift the keyboard away from the chassis as shown.



4. Turn over the keyboard on the Touch Pad area.



5. Disconnect both sides of the keyboard cable from the mainboard to remove the keyboard.



---

## Removing the Antenna

1. Remove the Antenna Cables from the securing pins as shown.

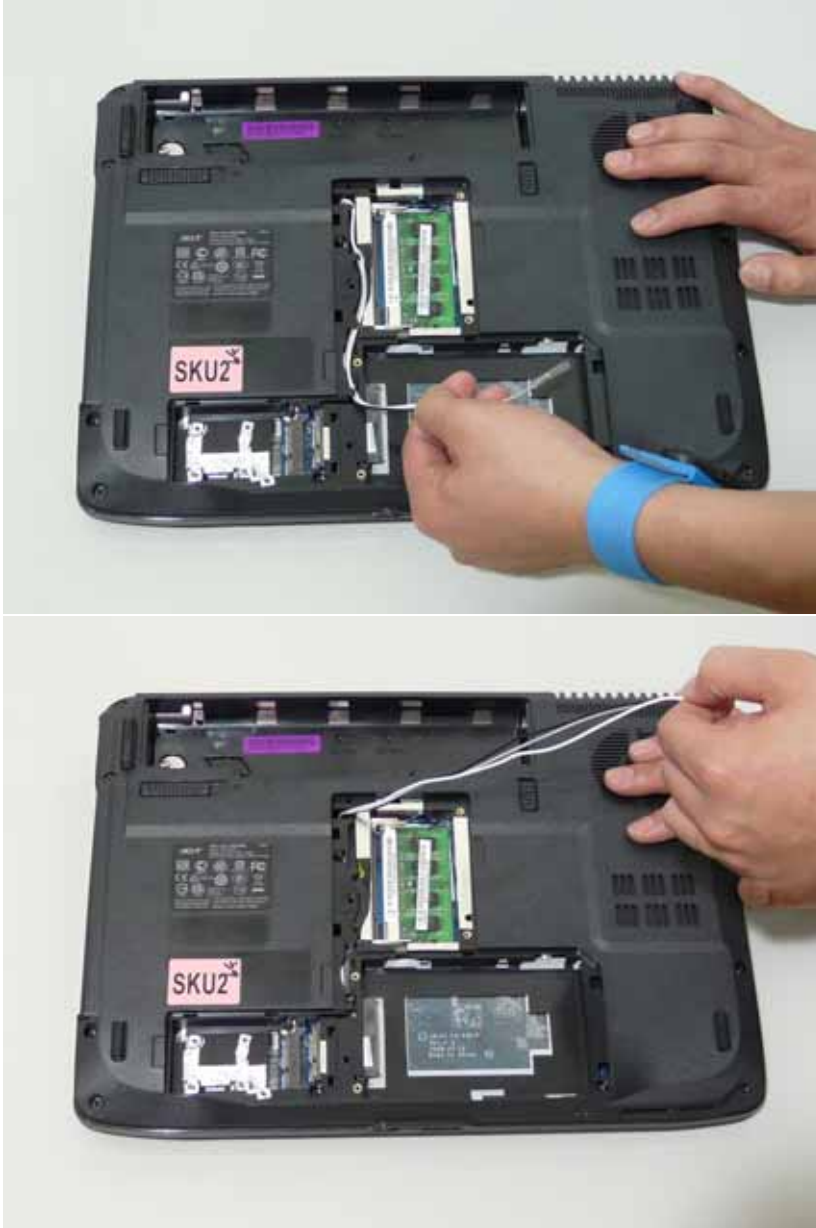



2. Turn the computer over. Remove the adhesive tape from the antenna cable.



3. Feed the antenna cables from the underside of the computer.



4. Remove the Antenna Cables from the securing pins as shown.



5. Pull the cables under the speaker panel as shown.



---

6. Place the antenna cable as shown to avoid damaging them.



# Removing the LCD Module

1. See “Removing the Battery Pack” on page 60.
2. See “Removing the Lower Covers” on page 63.
3. See “Removing the WLAN Board Module” on page 66.
4. See “Removing the Keyboard” on page 76.
5. See “Removing the Antenna” on page 78.
6. Remove the two securing screws from the bottom of the chassis.



Step	Size (Quantity)	Color	Torque
6	M2.5*5 NL (2)	Black	

7. Turn the computer over. Disconnect the three LCD interface cables from the chassis.



8. Remove the six securing screws from the LCD module.



Step	Size (Quantity)	Color	Torque
8	M2.5*8 NL (4)	Black	
8	M2.5*5 NL (2)	Black	

9. Carefully remove the LCD module from the chassis.



# Removing the Upper Cover

1. See “Removing the Battery Pack” on page 60.
2. See “Removing the SD dummy card” on page 61.
3. See “Removing the ExpressCard dummy card” on page 62.
4. See “Removing the Lower Covers” on page 63.
5. See “Removing the DIMM Module” on page 65.
6. See “Removing the WLAN Board Module” on page 66.
7. See “Removing the Hard Disk Drive Module” on page 68.
8. See “Removing the Optical Drive Module” on page 70.
9. See “Removing the Switch Cover” on page 74.
10. See “Removing the Keyboard” on page 76.
11. See “Removing the LCD Module” on page 82.
12. Turn the computer over. Remove the eight screws on the bottom panel.



Step	Size (Quantity)	Color	Torque
12	M2.5*8 NL (8)	Black	

13. Turn the computer over. Remove the seven screws on the top panel.



Step	Size (Quantity)	Color	Torque
13	M2.5*5 NL (7)	Black	

14. Disconnect the five cables from the mainboard as shown.



Disconnect A as shown.

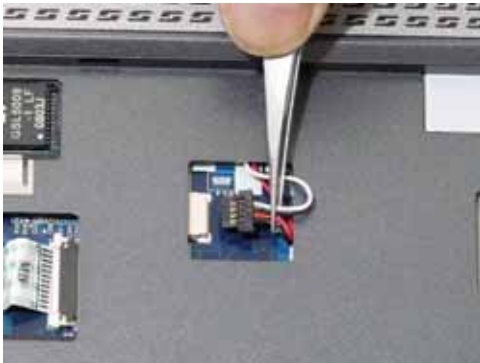

Release the securing latches and disconnect B as shown.



Release the securing latches and disconnect C as shown.



Release the securing latches and disconnect D as shown.

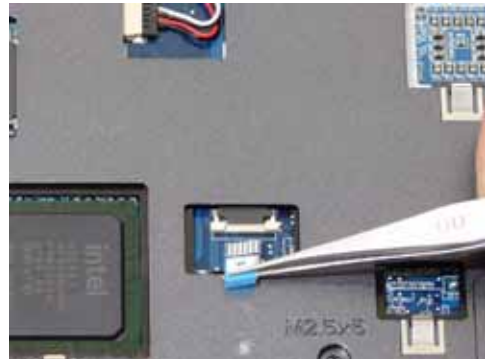

Release the securing latches and disconnect E as shown.





---

15. Remove the upper cover by lifting upward from the chassis, rear edge first.



16. Turn the upper cover over. The upper cover appears as follows.



---

## Removing the Touch Pad Bracket

1. See “Removing the Battery Pack” on page 60.
2. See “Removing the SD dummy card” on page 61.
3. See “Removing the ExpressCard dummy card” on page 62.
4. See “Removing the Lower Covers” on page 63.
5. See “Removing the DIMM Module” on page 65.
6. See “Removing the WLAN Board Module” on page 66.
7. See “Removing the Hard Disk Drive Module” on page 68.
8. See “Removing the Optical Drive Module” on page 70.
9. See “Removing the Keyboard” on page 76.
10. See “Removing the LCD Module” on page 82.
11. See “Removing the Upper Cover” on page 84.
12. Disconnect the Touch Pad cable from the Touch Pad board.

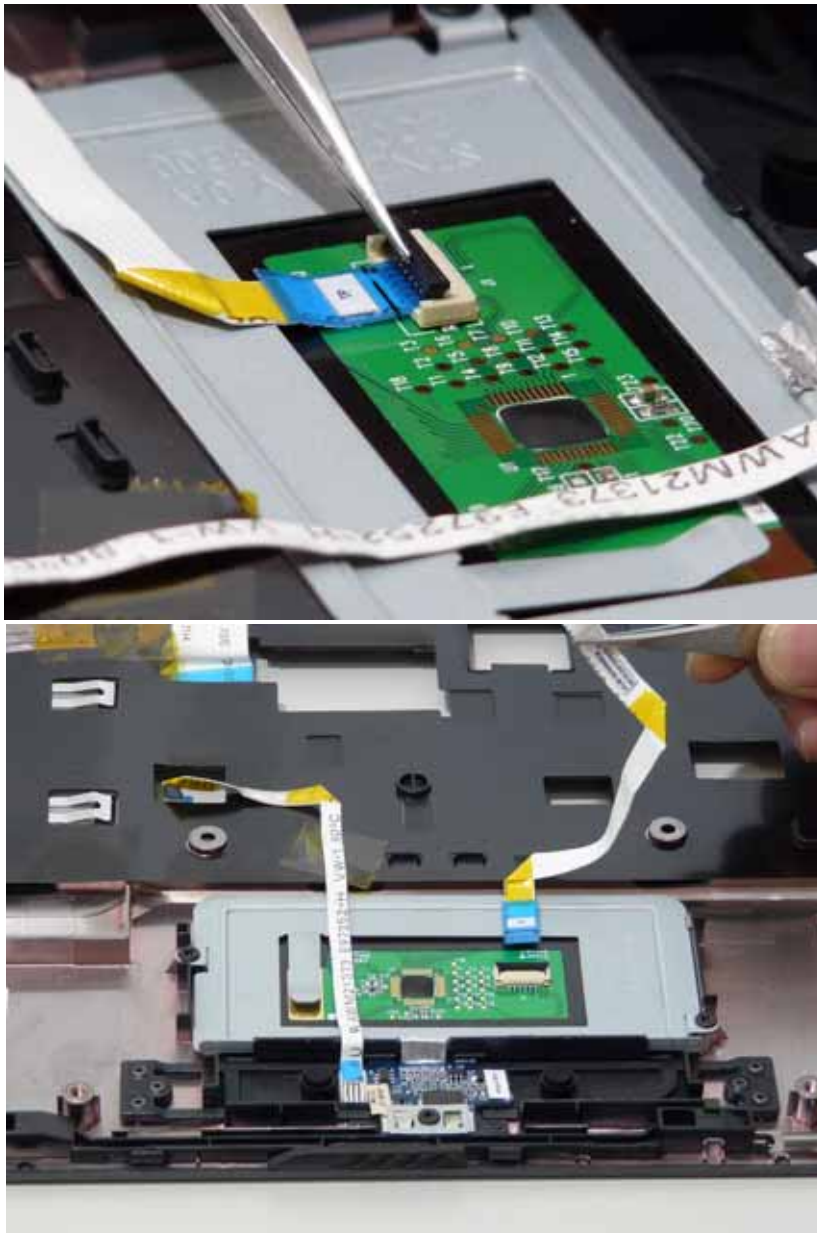

13. Move the Finger Print Reader FFC cable out of the way to prevent damage.



14. Remove the two securing screws from the Touch Pad bracket.



Step	Size (Quantity)	Color	Torque
14	M2*3 NL (2)	Black	

---

15. Remove the Touch Pad bracket.



**IMPORTANT:**The Touch Pad cannot be removed individually. To replace the Touch Pad, replace the entire Upper Cover.

---

## Removing the Finger Print Reader

1. See “Removing the Battery Pack” on page 60.
2. See “Removing the SD dummy card” on page 61.
3. See “Removing the ExpressCard dummy card” on page 62.
4. See “Removing the Lower Covers” on page 63.
5. See “Removing the DIMM Module” on page 65.
6. See “Removing the WLAN Board Module” on page 66.
7. See “Removing the Hard Disk Drive Module” on page 68.
8. See “Removing the Optical Drive Module” on page 70.
9. See “Removing the Keyboard” on page 76.
10. See “Removing the LCD Module” on page 82.
11. See “Removing the Upper Cover” on page 84.
12. Remove the securing screw from the Finger Print Reader board.



---

13. Remove the Finger Print Reader board from the Upper Cover.

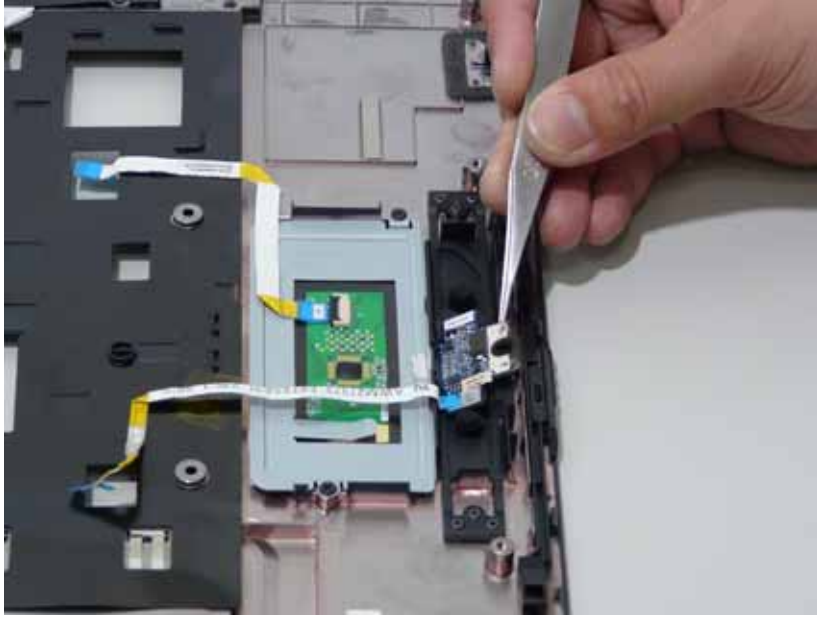

---

## Removing the Launch Board

1. See “Removing the Battery Pack” on page 60.
2. See “Removing the SD dummy card” on page 61.
3. See “Removing the ExpressCard dummy card” on page 62.
4. See “Removing the Lower Covers” on page 63.
5. See “Removing the DIMM Module” on page 65.
6. See “Removing the WLAN Board Module” on page 66.
7. See “Removing the Hard Disk Drive Module” on page 68.
8. See “Removing the Optical Drive Module” on page 70.
9. See “Removing the Keyboard” on page 76.
10. See “Removing the LCD Module” on page 82.
11. See “Removing the Upper Cover” on page 84.
12. Remove the two screws from the Launch Board.

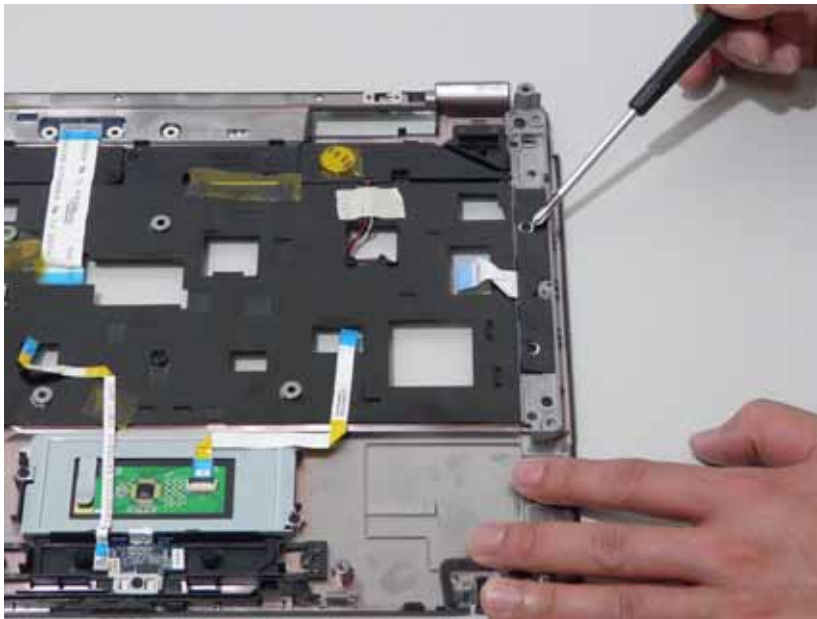

Step	Size (Quantity)	Color	Torque
12	M2*3 NL (2)	Black	

---

13. Remove the Launch Board from the Upper Cover.

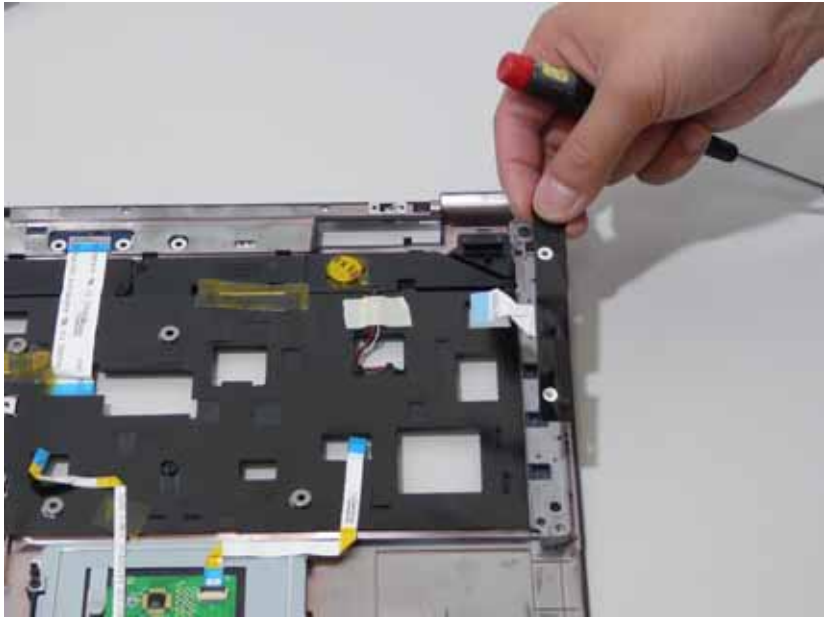



---

## Removing the Speaker Module

1. See “Removing the Battery Pack” on page 60.
2. See “Removing the SD dummy card” on page 61.
3. See “Removing the ExpressCard dummy card” on page 62.
4. See “Removing the Lower Covers” on page 63.
5. See “Removing the DIMM Module” on page 65.
6. See “Removing the WLAN Board Module” on page 66.
7. See “Removing the Hard Disk Drive Module” on page 68.
8. See “Removing the Optical Drive Module” on page 70.
9. See “Removing the Keyboard” on page 76.
10. See “Removing the LCD Module” on page 82.
11. See “Removing the Upper Cover” on page 84.
12. Remove the adhesive tape from the speaker cable.

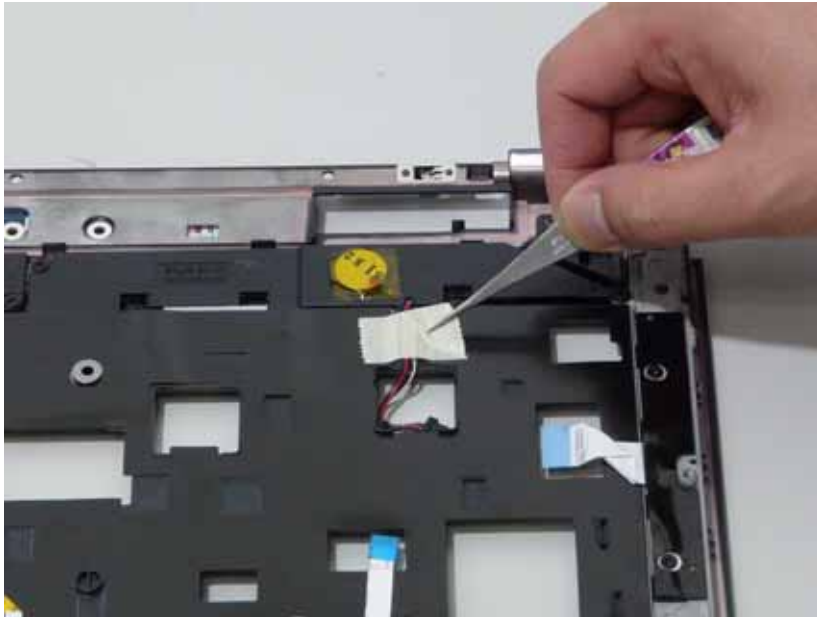

13. Remove the four screws holding the Speaker Module in place.



Step	Size (Quantity)	Color	Torque
13	M2*3 NL (4)	Black	

14. Remove the Speaker Module from the upper case.

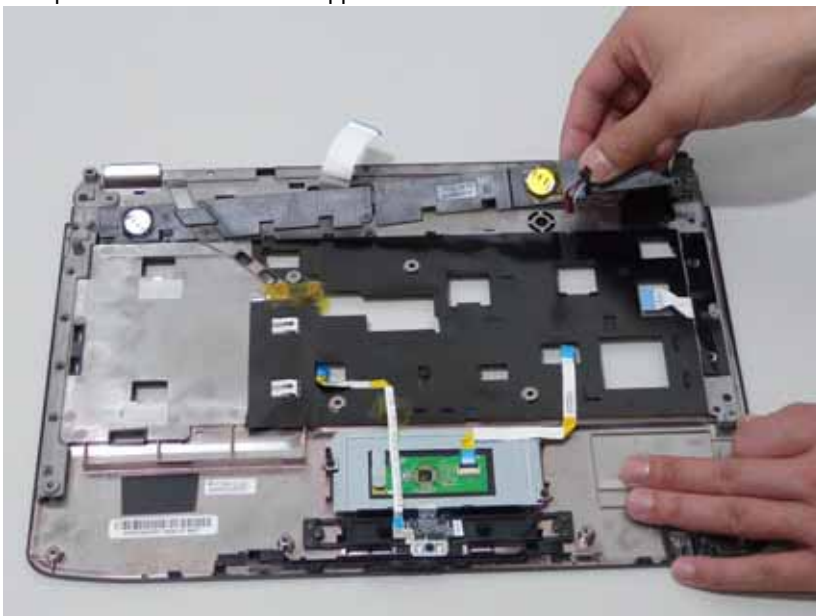

---

## Removing the Switch Board

1. See “Removing the Battery Pack” on page 60.
2. See “Removing the SD dummy card” on page 61.
3. See “Removing the ExpressCard dummy card” on page 62.
4. See “Removing the Lower Covers” on page 63.
5. See “Removing the DIMM Module” on page 65.
6. See “Removing the WLAN Board Module” on page 66.
7. See “Removing the Hard Disk Drive Module” on page 68.
8. See “Removing the Optical Drive Module” on page 70.
9. See “Removing the Keyboard” on page 76.
10. See “Removing the LCD Module” on page 82.
11. See “Removing the Upper Cover” on page 84.
12. Ensure the Switch Board cable is free from any obstructions.

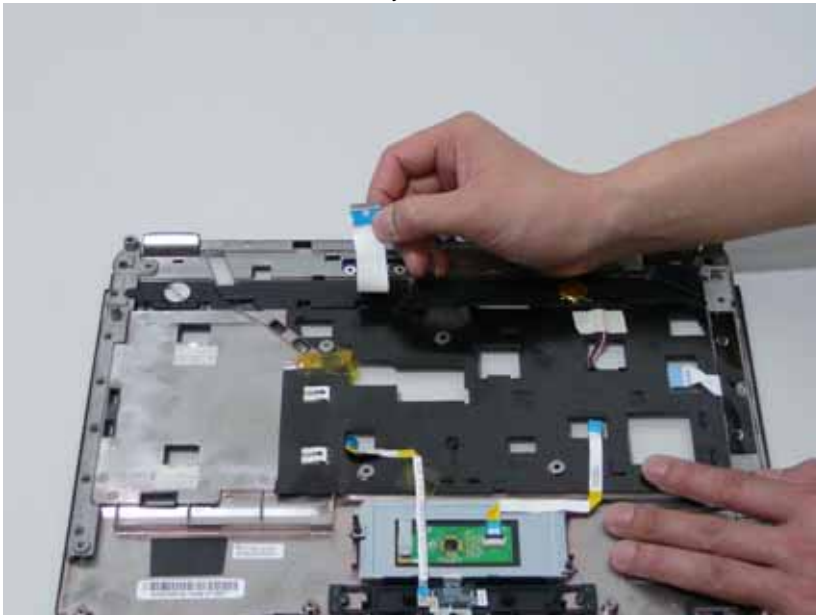

13. Turn the Upper Cover. Remove the Switch Board as shown.



---

## Removing the Touch Pad Board

**IMPORTANT:**The Touch Pad board is integrated into the design of the Upper Cover. To replace the Touch Pad board, remove all components from the Upper Cover and install an entirely new Upper Cover.

**IMPORTANT:**The MOSFET pad is attached to the Upper Cover and is reusable. If the replacement Upper Cover does not have a MOSFET pad (see highlighted area below), remove the MOSFET pad from the replaced Upper Cover and stick it to the new Upper Cover.

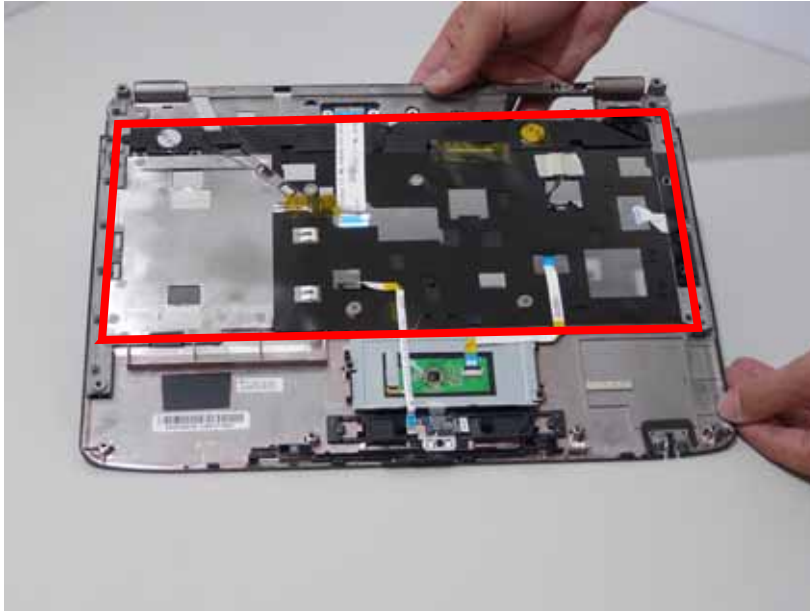

1. See "Removing the Battery Pack" on page 60.
2. See "Removing the SD dummy card" on page 61.
3. See "Removing the ExpressCard dummy card" on page 62.
4. See "Removing the Lower Covers" on page 63.
5. See "Removing the DIMM Module" on page 65.
6. See "Removing the WLAN Board Module" on page 66.
7. See "Removing the Hard Disk Drive Module" on page 68.
8. See "Removing the Optical Drive Module" on page 70.
9. See "Removing the Keyboard" on page 76.
10. See "Removing the LCD Module" on page 82.
11. See "Removing the Upper Cover" on page 84.
12. See "Removing the Touch Pad Bracket" on page 88.
13. See "Removing the Finger Print Reader" on page 91.
14. See "Removing the Launch Board" on page 93.
15. See "Removing the Speaker Module" on page 95.
16. See "Removing the Switch Board" on page 97.

## Removing the I/O Board

1. See "Removing the Battery Pack" on page 60.
2. See "Removing the SD dummy card" on page 61.
3. See "Removing the ExpressCard dummy card" on page 62.
4. See "Removing the Lower Covers" on page 63.
5. See "Removing the DIMM Module" on page 65.
6. See "Removing the WLAN Board Module" on page 66.
7. See "Removing the Hard Disk Drive Module" on page 68.
8. See "Removing the Optical Drive Module" on page 70.
9. See "Removing the Keyboard" on page 76.
10. See "Removing the LCD Module" on page 82.
11. See "Removing the Upper Cover" on page 84.
12. Remove the securing screw from the I/O Board.



Step	Size (Quantity)	Color	Torque
12	M2.5*5 NL (1)	Silver	

13. Lift the I/O Board clear of the Lower cover.



14. Disconnect the I/O Board cable and remove the board.



---

## Removing the Bluetooth board

1. See “Removing the Battery Pack” on page 60.
2. See “Removing the SD dummy card” on page 61.
3. See “Removing the ExpressCard dummy card” on page 62.
4. See “Removing the Lower Covers” on page 63.
5. See “Removing the DIMM Module” on page 65.
6. See “Removing the WLAN Board Module” on page 66.
7. See “Removing the Hard Disk Drive Module” on page 68.
8. See “Removing the Optical Drive Module” on page 70.
9. See “Removing the Keyboard” on page 76.
10. See “Removing the LCD Module” on page 82.
11. See “Removing the Upper Cover” on page 84.
12. Remove the securing screw from the Bluetooth board.



Step	Size (Quantity)	Color	Torque
14	M2*3 NL (1)	Black	

13. Lift the Bluetooth board away from the main board and disconnect the mainboard cable.

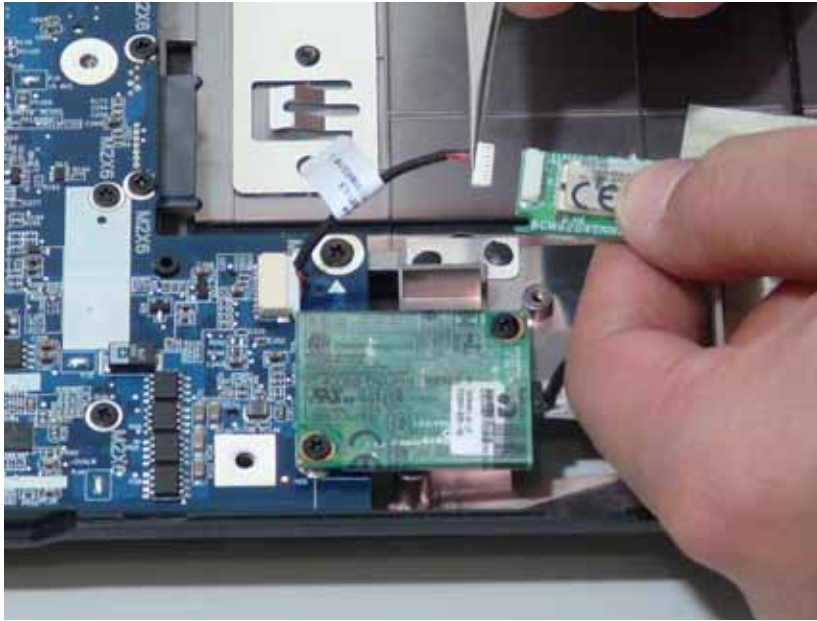

14. Disconnect the cable from the mainboard.

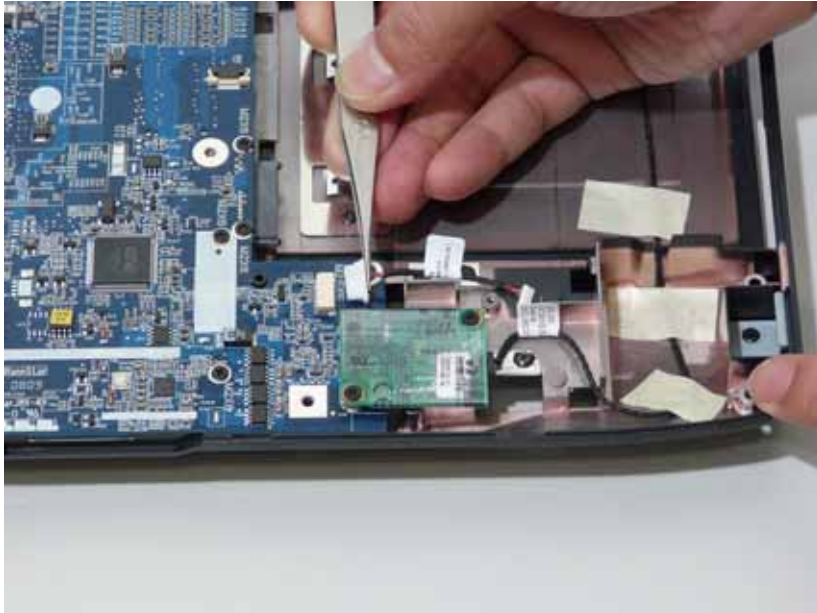



---

## Removing the Modem Module

1. See “Removing the Battery Pack” on page 60.
2. See “Removing the SD dummy card” on page 61.
3. See “Removing the ExpressCard dummy card” on page 62.
4. See “Removing the Lower Covers” on page 63.
5. See “Removing the DIMM Module” on page 65.
6. See “Removing the WLAN Board Module” on page 66.
7. See “Removing the Hard Disk Drive Module” on page 68.
8. See “Removing the Optical Drive Module” on page 70.
9. See “Removing the Keyboard” on page 76.
10. See “Removing the LCD Module” on page 82.
11. See “Removing the Upper Cover” on page 84.
12. Remove the adhesive tape securing the Modem cable to the Lower Cover.

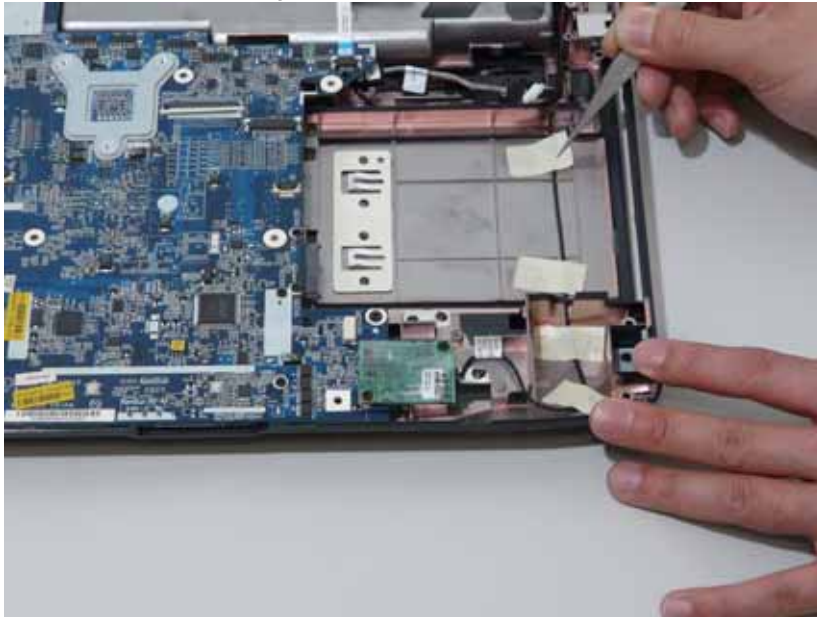

13. Remove the RJ-11 port from the leftside of the Lower Cover.

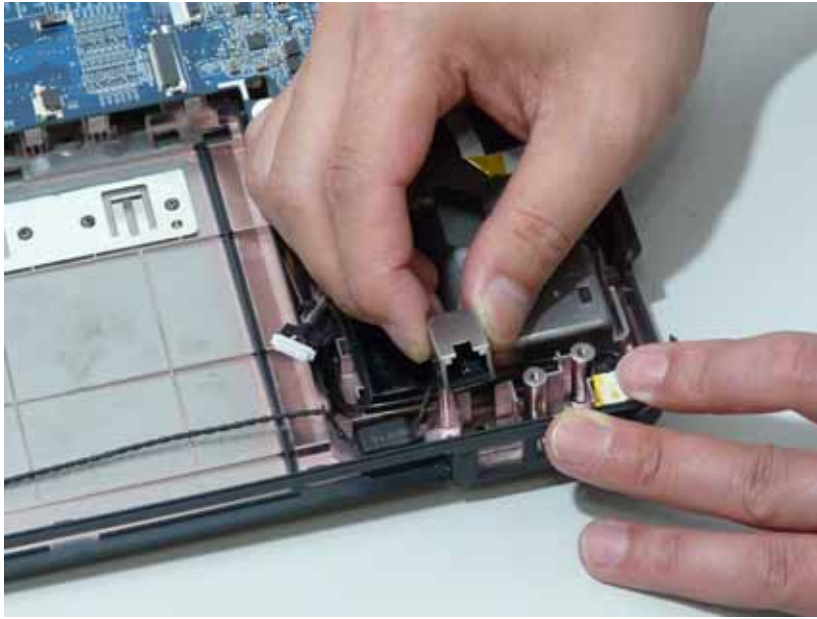

14. Disconnect the Modem cable from the Modem module.



15. Remove the two screws securing the Modem module.



Step	Size (Quantity)	Color	Torque
17	M2*3 NL (2)	Black	

16. Remove the Modem module from the Lower Cover.



---

## Removing the Main Board

1. See “Removing the Battery Pack” on page 60.
2. See “Removing the SD dummy card” on page 61.
3. See “Removing the ExpressCard dummy card” on page 62.
4. See “Removing the Lower Covers” on page 63.
5. See “Removing the DIMM Module” on page 65.
6. See “Removing the WLAN Board Module” on page 66.
7. See “Removing the Hard Disk Drive Module” on page 68.
8. See “Removing the Optical Drive Module” on page 70.
9. See “Removing the Keyboard” on page 76.
10. See “Removing the LCD Module” on page 82.
11. See “Removing the Upper Cover” on page 84.
12. Disconnect the power jack from the power port on the Lower Cover.



13. Lift the cabling clear of the securing pins and ensure it is free of obstruction.

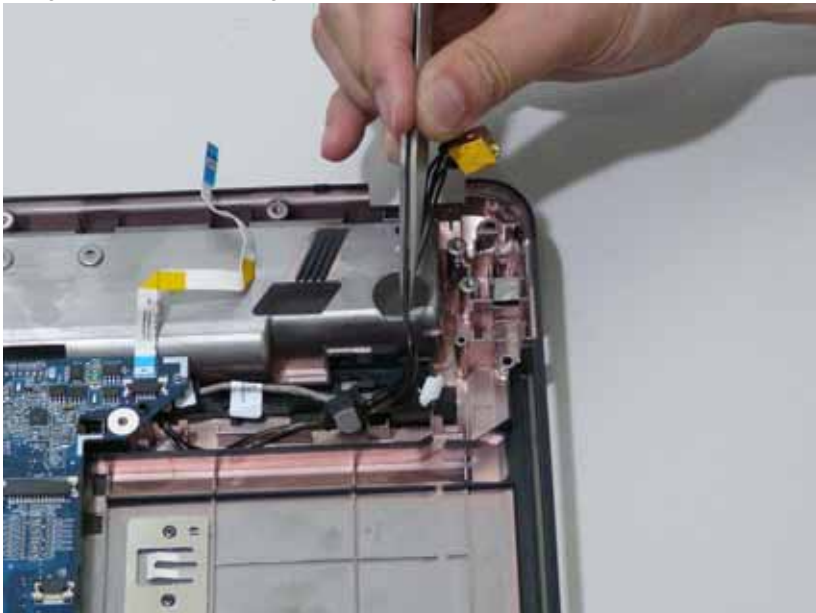

14. Remove the securing screw from the Mainboard.



Step	Size (Quantity)	Color	Torque
16	M2.5*5 NL (1)	Black	

15. Remove the main board, rightside first, as shown.

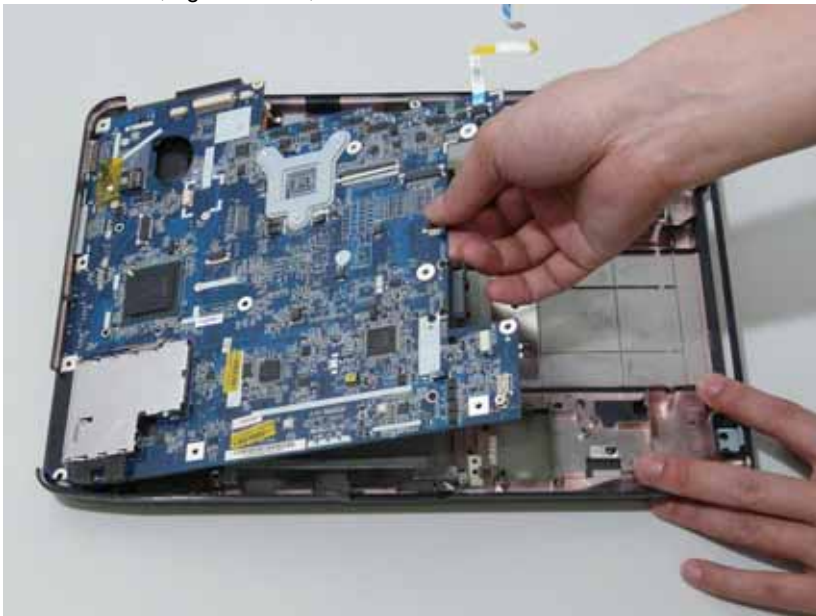

16. Release the securing latches and remove the Switch Cover FFC.

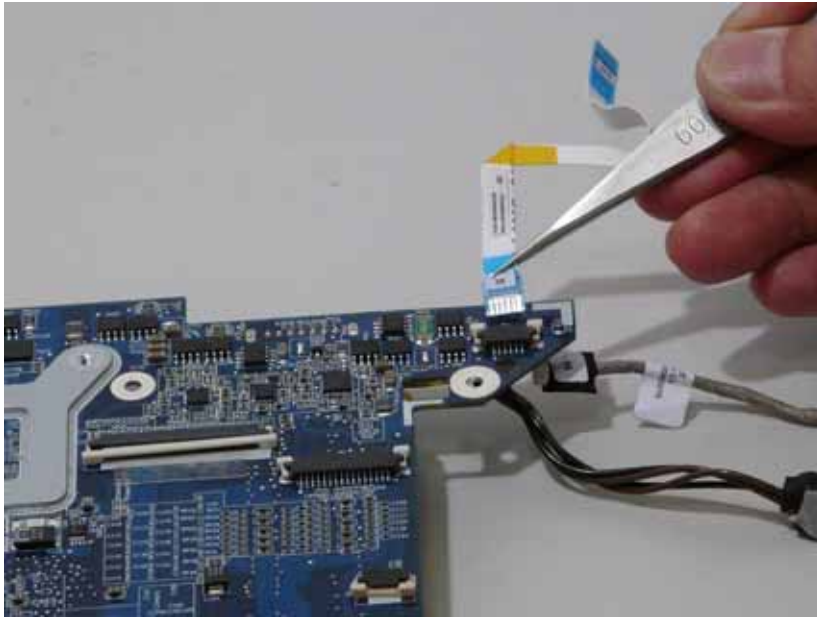

17. Turn the Mainboard over. Disconnect the I/O Cable from the Mainboard.



18. Disconnect the DC IN Cable from the Mainboard.

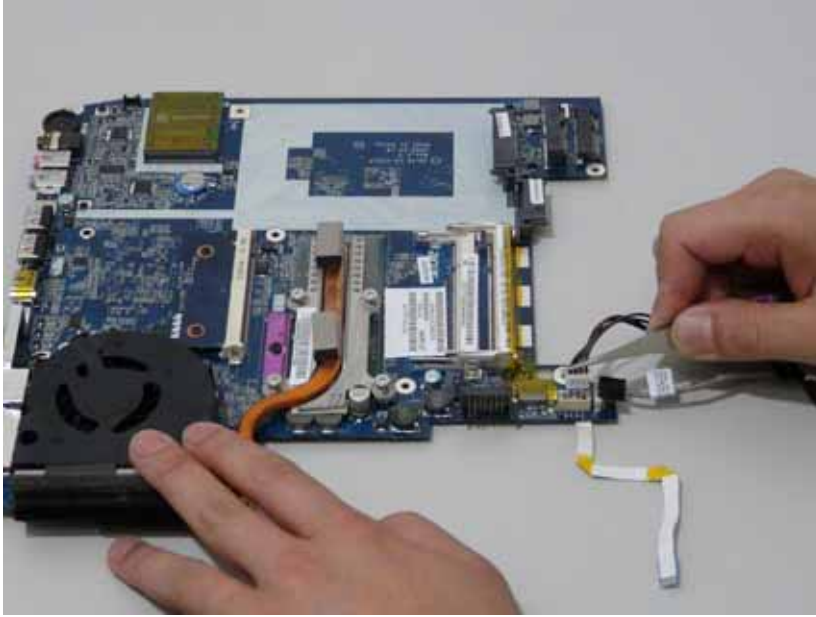

## Removing the Thermal Module

1. See “Removing the Battery Pack” on page 60.
2. See “Removing the SD dummy card” on page 61.
3. See “Removing the ExpressCard dummy card” on page 62.
4. See “Removing the Lower Covers” on page 63.
5. See “Removing the DIMM Module” on page 65.
6. See “Removing the WLAN Board Module” on page 66.
7. See “Removing the Hard Disk Drive Module” on page 68.
8. See “Removing the Optical Drive Module” on page 70.
9. See “Removing the Keyboard” on page 76.
10. See “Removing the LCD Module” on page 82.
11. See “Removing the Upper Cover” on page 84.
12. See “Removing the Main Board” on page 106.
13. Remove the four securing screws from the Thermal Module.



Step	Size (Quantity)	Color	Torque
15	M2.5*6.5 (4)	Black	



---

14. Lift the Thermal Module clear of the Mainboard.



---

## Removing the CPU

1. See “Removing the Battery Pack” on page 60.
2. See “Removing the SD dummy card” on page 61.
3. See “Removing the ExpressCard dummy card” on page 62.
4. See “Removing the Lower Covers” on page 63.
5. See “Removing the DIMM Module” on page 65.
6. See “Removing the WLAN Board Module” on page 66.
7. See “Removing the Hard Disk Drive Module” on page 68.
8. See “Removing the Optical Drive Module” on page 70.
9. See “Removing the Keyboard” on page 76.
10. See “Removing the LCD Module” on page 82.
11. See “Removing the Upper Cover” on page 84.
12. See “Removing the Main Board” on page 106.
13. See “Removing the Thermal Module” on page 110.
14. Using a flat screwdriver, turn the CPU socket latch counter-clockwise to release the CPU.



15. Lift the CPU clear of the Mainboard.



---

## Removing the CPU Fan

1. See “Removing the Battery Pack” on page 60.
2. See “Removing the SD dummy card” on page 61.
3. See “Removing the ExpressCard dummy card” on page 62.
4. See “Removing the Lower Covers” on page 63.
5. See “Removing the DIMM Module” on page 65.
6. See “Removing the WLAN Board Module” on page 66.
7. See “Removing the Hard Disk Drive Module” on page 68.
8. See “Removing the Optical Drive Module” on page 70.
9. See “Removing the Keyboard” on page 76.
10. See “Removing the LCD Module” on page 82.
11. See “Removing the Upper Cover” on page 84.
12. See “Removing the Main Board” on page 106.
13. Disconnect the Fan cable from the Mainboard.



14. Remove the three securing screws from the Fan module.



Step	Size (Quantity)	Color	Torque
16	M2*4-NI NL (3)	Black	

15. Lift the Fan module clear of the Mainboard.

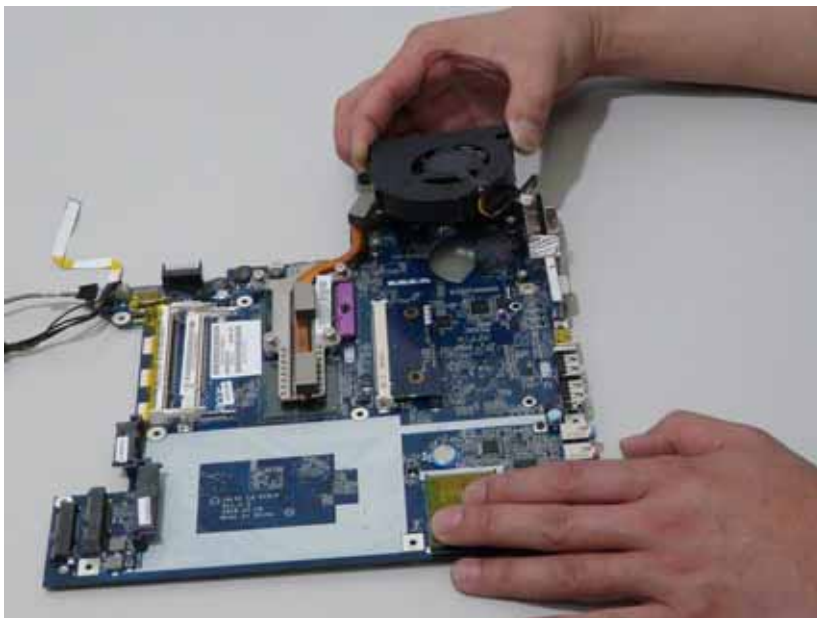

## Removing the HDMI Module

1. See “Removing the Battery Pack” on page 60.
2. See “Removing the SD dummy card” on page 61.
3. See “Removing the ExpressCard dummy card” on page 62.
4. See “Removing the Lower Covers” on page 63.
5. See “Removing the DIMM Module” on page 65.
6. See “Removing the WLAN Board Module” on page 66.
7. See “Removing the Hard Disk Drive Module” on page 68.
8. See “Removing the Optical Drive Module” on page 70.
9. See “Removing the Keyboard” on page 76.
10. See “Removing the LCD Module” on page 82.
11. See “Removing the Upper Cover” on page 84.
12. See “Removing the Main Board” on page 106.
13. Remove the two securing screws from the HDMI Module.



Step	Size (Quantity)	Color	Torque
15	M2*4-NI NL (2)	Black	

---

14. Remove the HDMI Module as shown.

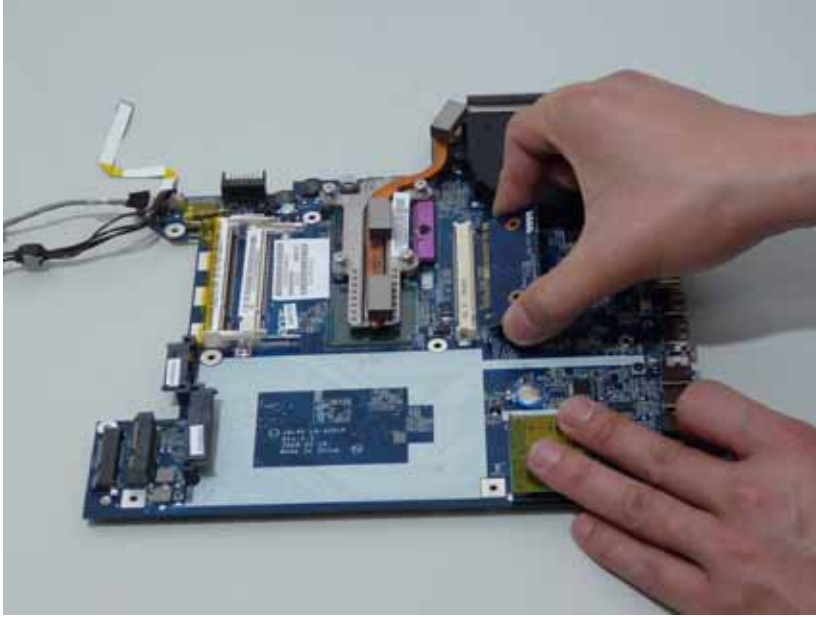

# LCD Module Disassembly Process

## LCD Module Disassembly Flowchart

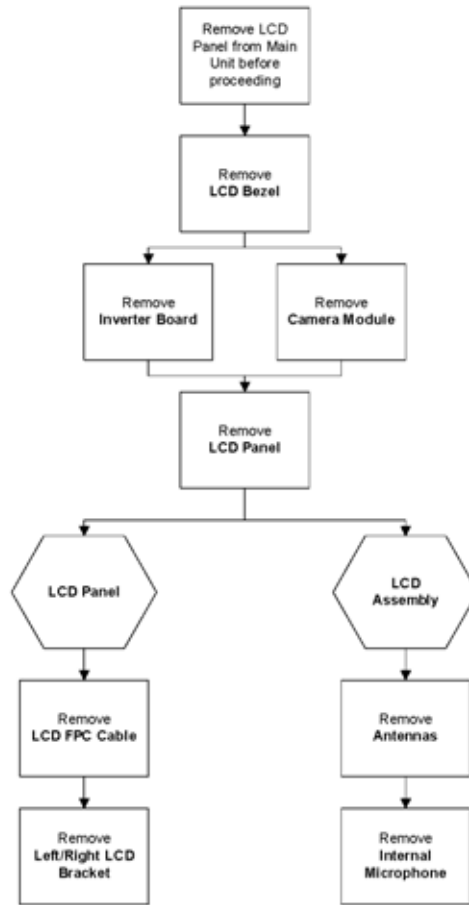

### Screw List

Item	Screw	Color	Part No.
E	M2.5 x L5	Black	86.00F87.735
G	M2 x L3	Silver	86.9A552.3R0
I	M2.5 x L4	Silver	86.00E41.134



---

## Removing the LCD Bezel

1. See “Removing the Battery Pack” on page 60.
2. See “Removing the SD dummy card” on page 61.
3. See “Removing the ExpressCard dummy card” on page 62.
4. See “Removing the Lower Covers” on page 63.
5. See “Removing the WLAN Board Module” on page 66.
6. See “Removing the Keyboard” on page 76.
7. See “Removing the LCD Module” on page 82.
8. Remove the two upper and two lower bezel screw caps.



9. Remove the four securing screws from the LCD module.



Step	Size (Quantity)	Color	Torque
9	M2.5*5 NL (4)	Black	

10. Lift up the bezel, rightside first, and remove it from the LCD Module.



---

## Removing the Inverter Board

1. See “Removing the Battery Pack” on page 60.
2. See “Removing the SD dummy card” on page 61.
3. See “Removing the ExpressCard dummy card” on page 62.
4. See “Removing the Lower Covers” on page 63.
5. See “Removing the WLAN Board Module” on page 66.
6. See “Removing the Keyboard” on page 76.
7. See “Removing the LCD Module” on page 82.
8. See “Removing the LCD Bezel” on page 119.
9. Disconnect the left and right Inverter board cables as shown.



10. Remove the securing screw from the Inverter board.



Step	Size (Quantity)	Color	Torque
10	M2.5*5 NL (1)	Black	

11. Lift the Inverter board clear of the LCM Module.



---

## Removing the Camera Module

1. See “Removing the Battery Pack” on page 60.
2. See “Removing the SD dummy card” on page 61.
3. See “Removing the ExpressCard dummy card” on page 62.
4. See “Removing the Lower Covers” on page 63.
5. See “Removing the WLAN Board Module” on page 66.
6. See “Removing the Keyboard” on page 76.
7. See “Removing the LCD Module” on page 82.
8. See “Removing the LCD Bezel” on page 119.
9. Disconnect the Camera Module cable as shown.



10. Remove the two securing screws from the Camera Module.



Step	Size (Quantity)	Color	Torque
10	M2*3 NL (2)	Black	

---

11. Lift the Camera Module clear of the LCD Module.



## Removing the LCD Panel

1. See “Removing the Battery Pack” on page 60.
2. See “Removing the SD dummy card” on page 61.
3. See “Removing the ExpressCard dummy card” on page 62.
4. See “Removing the Lower Covers” on page 63.
5. See “Removing the WLAN Board Module” on page 66.
6. See “Removing the Keyboard” on page 76.
7. See “Removing the LCD Module” on page 82.
8. See “Removing the LCD Bezel” on page 119.
9. Remove the two securing screws from the LCD Module.



Step	Size (Quantity)	Color	Torque
9	M2.5*5 NL (2)	Black	

10. Lift the LCD Panel clear of the LCD Module.



---

## Removing the LCD Brackets and FPC Cable

1. See “Removing the Battery Pack” on page 60.
2. See “Removing the SD dummy card” on page 61.
3. See “Removing the ExpressCard dummy card” on page 62.
4. See “Removing the Lower Covers” on page 63.
5. See “Removing the WLAN Board Module” on page 66.
6. See “Removing the Keyboard” on page 76.
7. See “Removing the LCD Module” on page 82.
8. See “Removing the LCD Bezel” on page 119.
9. See “Removing the LCD Panel” on page 125.
10. Turn the LCD panel over to expose the rear. Grip the FPC cable and lift upward to detach the adhesive pads.

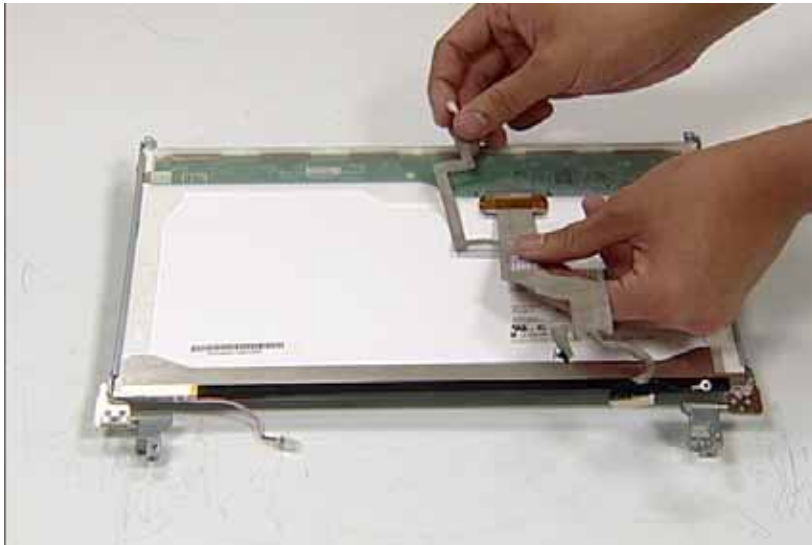



11. Remove the eight securing screws (four on each side) from the LCD Panel brackets.



Step	Size (Quantity)	Color	Torque
11	M2*3 NL (8)	Silver	

---

12. Remove the LCD brackets by pulling away from the LCD Panel as shown.



---

## Removing the Antennas

1. See “Removing the Battery Pack” on page 60.
2. See “Removing the SD dummy card” on page 61.
3. See “Removing the ExpressCard dummy card” on page 62.
4. See “Removing the Lower Covers” on page 63.
5. See “Removing the WLAN Board Module” on page 66.
6. See “Removing the Keyboard” on page 76.
7. See “Removing the LCD Module” on page 82.
8. See “Removing the LCD Bezel” on page 119.
9. See “Removing the LCD Panel” on page 125.
10. Remove the strips holding the antenna cables in place. Ensure the cables are free from obstructions.

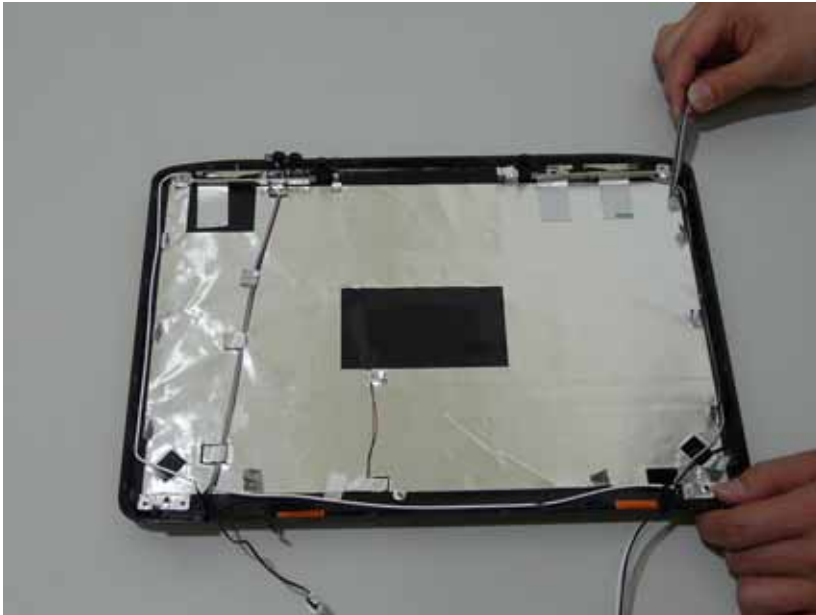

11. Remove the tab securing the left and right antennas to the LCD module.

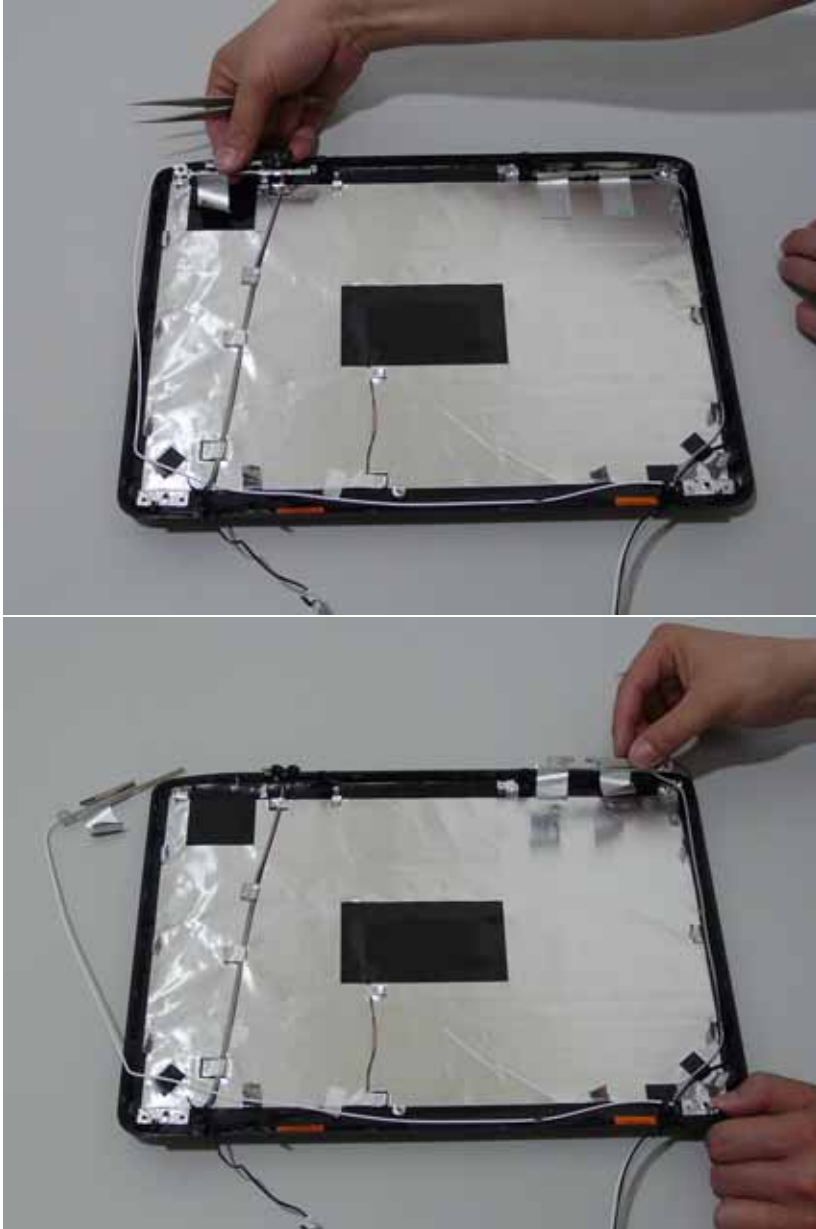

12. Remove the antenna cables and assembly from the LCD module.

---

## Removing the MIC Module

1. See “Removing the Battery Pack” on page 60.
2. See “Removing the SD dummy card” on page 61.
3. See “Removing the ExpressCard dummy card” on page 62.
4. See “Removing the Lower Covers” on page 63.
5. See “Removing the WLAN Board Module” on page 66.
6. See “Removing the Keyboard” on page 76.
7. See “Removing the LCD Module” on page 82.
8. See “Removing the LCD Bezel” on page 119.
9. See “Removing the LCD Panel” on page 125.
10. See “Removing the Antennas” on page 129.
11. Remove the mylar strips holding the MIC Module cable in place. Ensure the cable is free from obstructions.

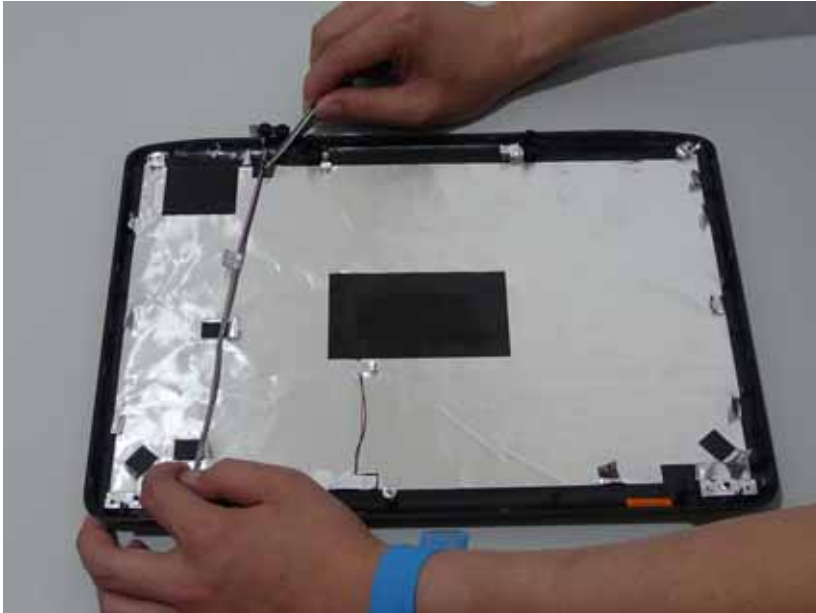

12. Remove the MIC cable and Module from the LCD module.

---

# LCM Module Reassembly Procedure

## Replacing the LCD Panel

1. Align the LCD brackets with the four screw holes (two on each side) on the LCD Panel as shown.



2. Secure the LCD brackets to the LCD panel.

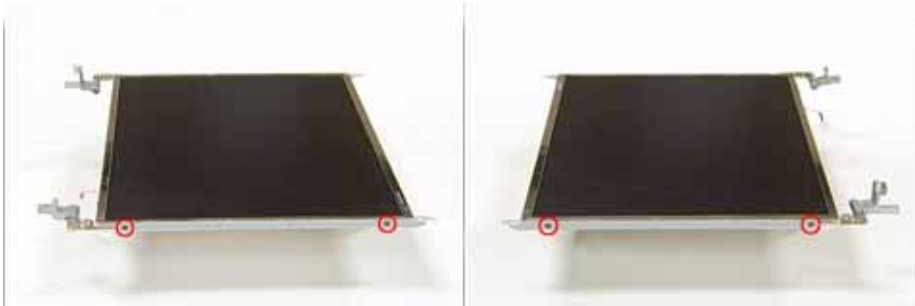

3. Turn the panel over. Insert the LCD Panel cable into the LCD Panel as shown.

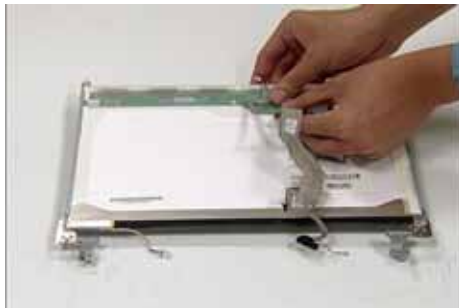

4. Align the LCD Panel cable as shown and press down to engage the adhesive pads.

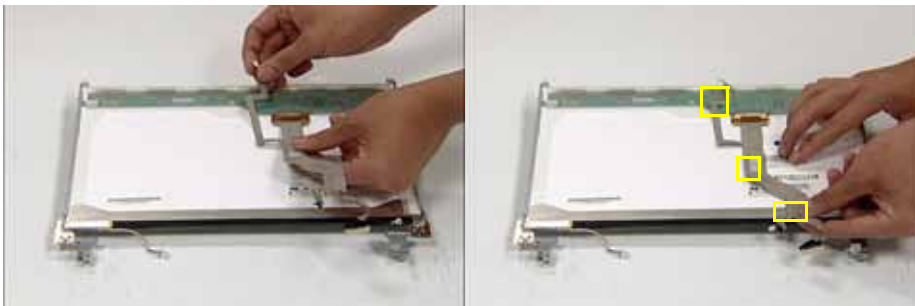

- 
5. Replace the MIC cable under the mylar tab strips, and replace the MIC as shown. Secure the cable by pressing down on the strips.

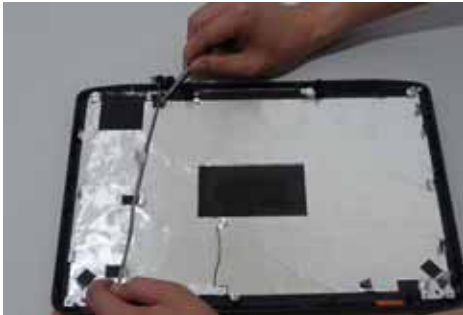

6. Replace the antenna cable as shown. Ensure that the cable is inserted under each tab strip.

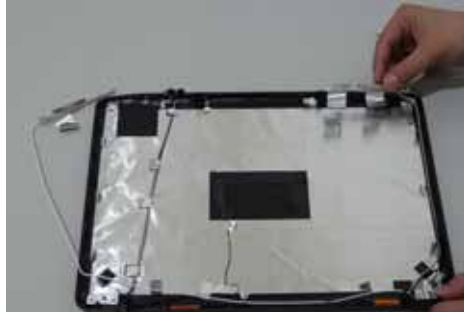

7. Secure the cable by pressing down on the securing strip.

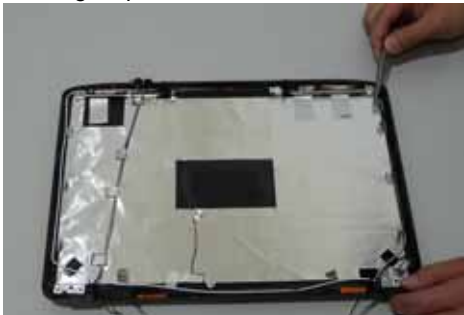

8. Place the LCD Panel in the back cover.



9. Secure the LCD module with the two securing screws.



10. Insert the Camera Module (adhesive side down), and secure by pressing down to insure cohesion.



11. Replace the two securing screws.



12. Connect the Camera Module cable.



13. Replace the Inverter board and secure with the single screw.



14. Connect the left and right Inverter cables.



## Replacing the LCM Bezel

1. Locate the bezel correctly and press down the edges until there are no gaps between the bezel and the LCM Module,



2. Replace the four screws and the rubber screw caps provided.





---

# Main Module Reassembly Procedure

## Replacing the CPU

1. Carefully turn the mainboard upside down (CPU side up), and insert the CPU into the CPU bracket as shown.
2. Using a plastic screw driver, lock the CPU in the socket as shown.



## Replacing the Thermal Module

1. Align and place the Thermal Module in the mounting as shown.



2. Replace the four securing screws to secure the Thermal Module.



---

## Replacing the CPU Fan Module

1. Align the Fan Module on the screw brackets.
2. Replace the 3 screws and secure.



3. Connect the Fan cable to the Mainboard.



## Replacing the HDMI Module

1. Insert the HDMI Module as shown, and press down to locate in place.
2. Replace the 2 screws to secure.

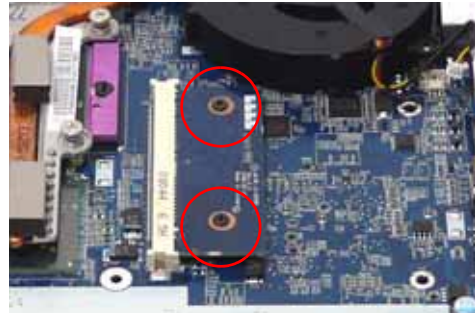

# Replacing the Mainboard

1. Turn the Mainboard over (CPU side). Connect the I/O cable.
2. Replace the Switch Cover FFC and lock the securing latches in place.



3. Ensure that the Mainboard is face up (the Heatsink and CPU are not visible). Place the Mainboard in the chassis, rear edge first, and press down to install. Replace the two securing screws as shown.

**NOTE:** Make sure the I/O ports are positioned correctly through the lower cover, and the screw sockets are visible through the mainboard.

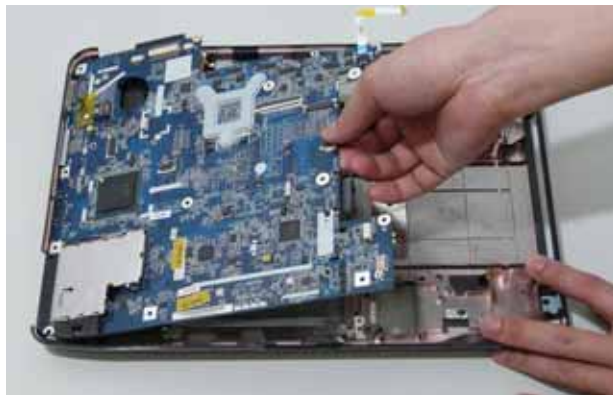

4. Replace the securing screw.
5. Replace the cabling through the securing pins.



6. Connect the power jack to the power port on the Lower Cover.

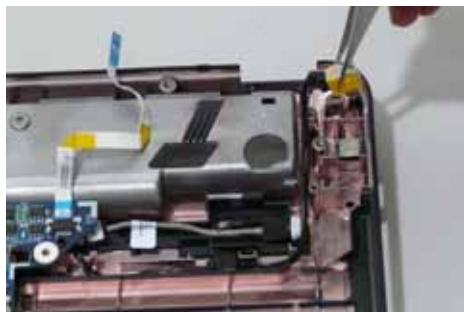

---

## Replacing the I/O Board

1. Connect the FFC to the I/O Board



2. Locate the I/O over the lower cover and replace.

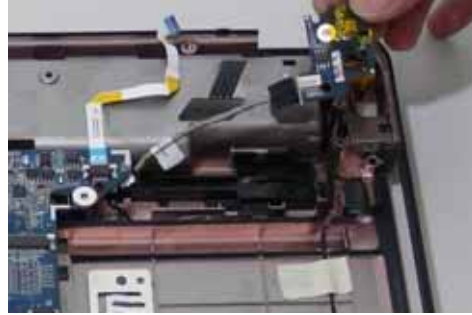

3. Replace the single securing screw.

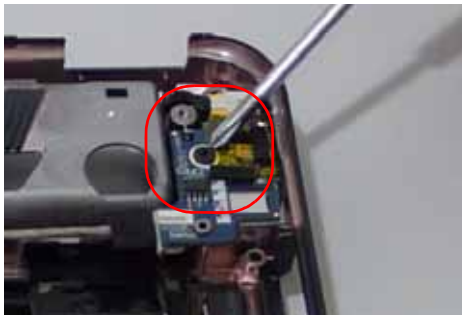

## Replacing the Bluetooth Board

1. Connect one end of the Bluetooth cable to the mainboard as shown.



2. Connect the other end of the Bluetooth cable to the Bluetooth Module as shown.



3. Locate the Bluetooth Module and replace the single securing screw.



---

## Replacing the Modem Module

1. Locate and replace the Modem Module as shown.



2. Connect the Modem cable to the Modem Module as shown.

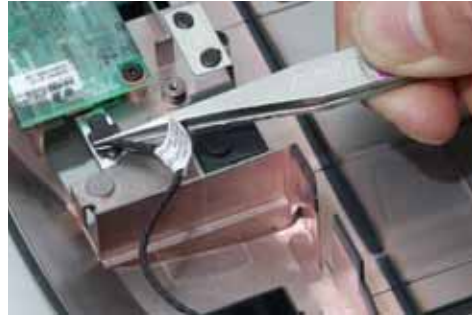

3. Connect the RJ-11 port to the leftside of the Lower Cover.



4. Replace the adhesive tape to secure the Modem cable to the Lower Cover.



---

## Replacing the Finger Print Reader

1. Replace the Finger Print Reader board in the upper cover.

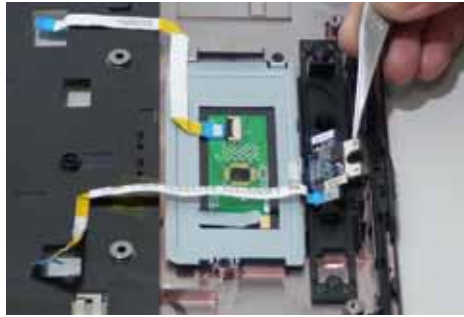

2. Replace the securing screw.



3. Secure the FFC to the upper cover by using the adhesive tape.

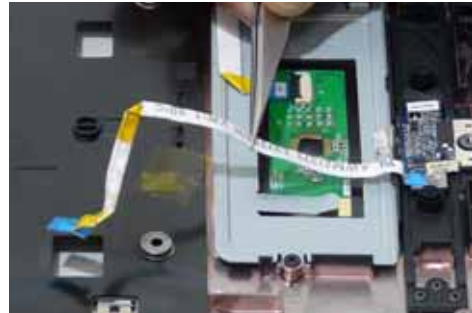

---

# Replacing the Touch Pad

**IMPORTANT:**The Touch Pad cannot be removed individually. To replace the Touch Pad, replace the entire Upper Cover.

1. Replace the Touch Pad bracket.



2. Replace the two securing screws from the Touch Pad bracket.



3. Replace the Finger Print reader FFC and secure with the adhesive strips.



4. Replace the Touch Pad FFC and secure with the adhesive strips.

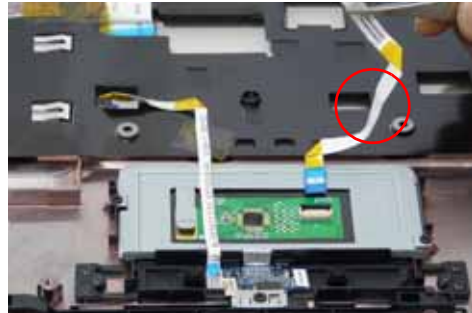

5. Connect the Touch Pad cable to the Touch Pad board.



---

## Replacing the Launch Board

1. Replace the Speaker Module on the upper case.
2. Replace the four securing screws.

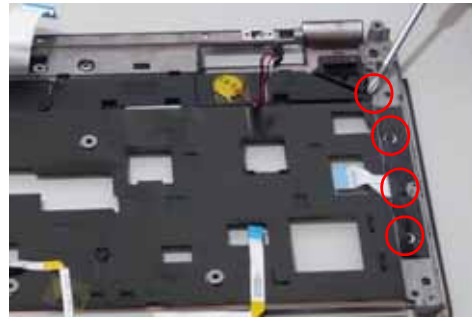

3. Replace adhesive strip to secure the cables to the upper case.



## Replacing the Switch Board

1. Turn the Upper Cover over and insert the FFC through the cover as shown.
2. Flip the Upper Cover over and replace the Switch Board as shown.

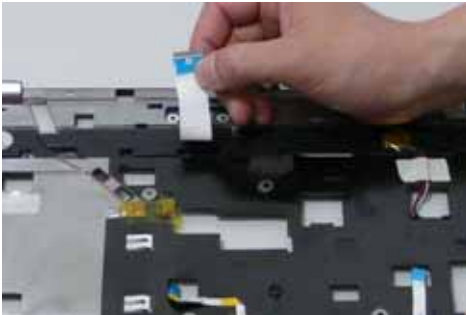



---

## Replacing the Antenna Cables

Ensure that the three Antenna cables pass through the Mainboard and are accessible from the underside of lower cover.

1. Insert the Antenna Cables through the Upper Cover. Make sure they are accessible from the underside.
2. Secure the cables in place as seen.

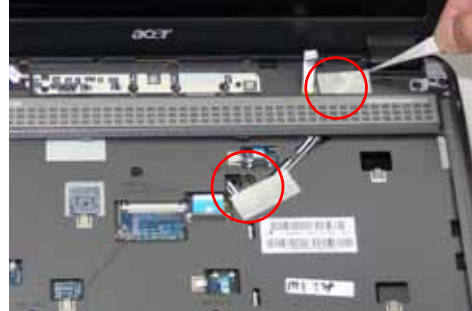

3. Pull the cables through.



4. Place the cabling in the wiring conduit as shown.

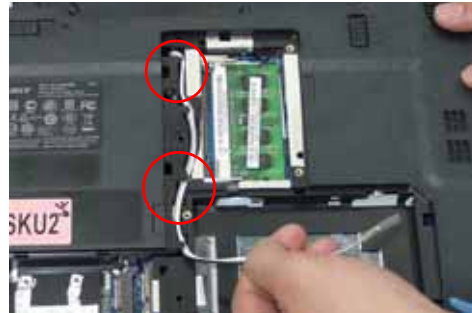

---

## Replacing the Speaker Module

1. Align and replace the Speaker Module to the upper case.
2. Replace the four securing screws.



3. Attach the adhesive strip on the speaker cabling to secure in place.

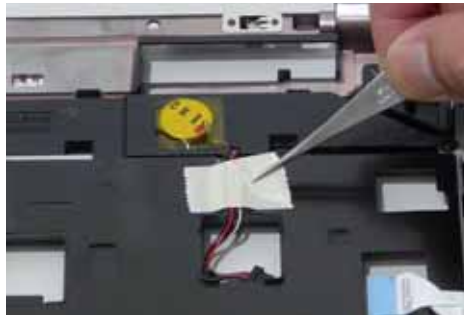

## Replacing the Keyboard

1. Replace keyboard cable to the mainboard, and secure the locking latch.
2. Turn the keyboard over and place the front edge first in the mounting.



3. Press down on the areas marked below to secure in place.



---

## Replacing the Switch Cover

1. Connect the Switch Cover FFC as shown.
2. Replace the Switch cover, and press down to secure in place.



3. Turn the computer over and replace the two securing screws.



## Replacing the WLAN Module

1. Insert the WLAN board into the WLAN socket.
2. Replace the two screws to secure the module.



3. Connect the two antenna cables to the module.



## Replacing the Hard Disk Drive Module

1. Place the HDD in the HDD carrier.
2. Replace the four screws to secure the carrier.

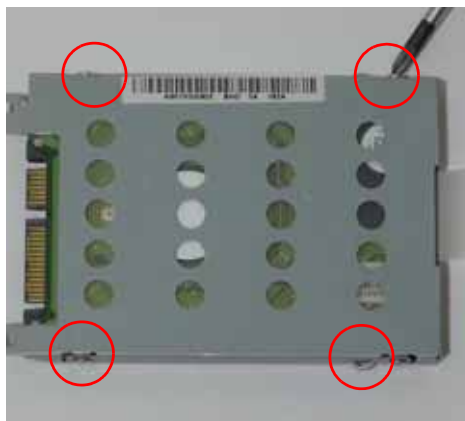

3. Insert the HDD, interface side first, until HDD firmly slides in place.
4. Push the HDD down to secure in place.

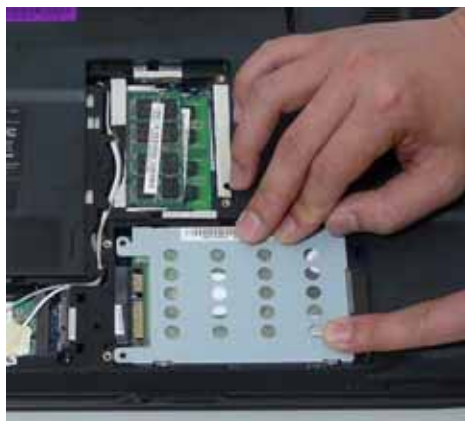

---

## Replacing the DIMM Modules

**NOTE:** To replace DIMM Module 2, first remove DIMM Module 1. In this procedure, only DIMM Module 1 is shown.

1. Insert the DIMM Module in place.



2. Press down to lock DIMM module.



## Replacing the ODD Module

1. With the ODD tray in the eject position, replace the ODD cover on the new ODD Module.
2. Press the cover into the tray, bottom edge first, to secure.



3. Turn ODD Module around and secure bracket with two screws.
4. Slide Module in chassis and press until Module is flush with chassis.



5. Replace the single screw to secure Module.



## Replacing the Lower Covers

1. Replace the Memory Cover.
2. Replace the two screws to secure in place.



3. Replace the WLAN Cover.



4. Replace the screw to secure in place.



5. Replace HDD Cover.



6. Replace the two screws to secure in place.



## Replacing the Express and SD Card Trays

1. Insert the Express Card and push into the slot until flush with the chassis cover.
2. Insert the SD Card and push into the slot until flush with the chassis cover.







# Troubleshooting

---

## Common Problems

Use the following procedure as a guide for computer problems.

**NOTE:** The diagnostic tests are intended to test only Acer products. Non-Acer products, prototype cards, or modified options can give false errors and invalid system responses.

1. Obtain the failing symptoms in as much detail as possible.
2. Verify the symptoms by attempting to re-create the failure by running the diagnostic test or by repeating the same operation.
3. Use the following table with the verified symptom to determine which page to go to.

Symptoms (Verified)	Go To
Power On Issue	Page 152
No Display Issue	Page 153
LCD Failure	Page 155
Internal Keyboard Failure	Page 155
Touch Pad Failure	Page 156
Internal Speaker Failure	Page 156
Internal Microphone Failure	Page 158
ODD Failure	Page 160
Rightside USB Failure	Page 163
Modem Failure	Page 163
WLAN Failure	Page 164
Acer EasyLaunch Button Failure	Page 164
Acer MediaTouch Failure	Page 165
Fingerprint Reader Failure	Page 165
Thermal Unit Failure	Page 166
HDTV Switch Failure	Page 166
Other Functions Failure	Page 167
Intermittent Failures	Page 168
Undermined Failures	Page 168

4. If the Issue is still not resolved, see "Online Support Information" on page 209.

---

## Power On Issue

If the system doesn't power on, perform the following actions one at a time to correct the problem. Do not replace a non-defective FRUs:

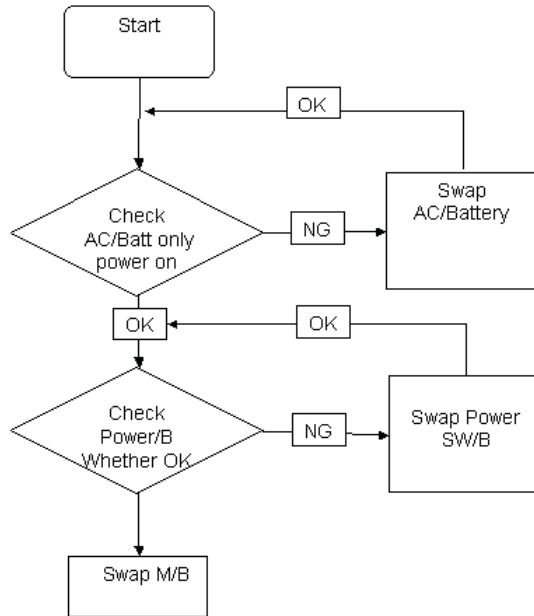

## Computer Shutdown Intermittently

If the system powers off at intervals, perform the following actions one at a time to correct the problem.

1. Check the power cable is properly connected to the computer and the electrical outlet.
2. Remove any extension cables between the computer and the outlet.
3. Remove any surge protectors between the computer and the electrical outlet. Plug the computer directly into a known good electrical outlet.
4. Disconnect the power and open the casing to check the Thermal Unit (see "Thermal Unit Failure" on page 166) and fan airways are free of obstructions.
5. Disable the power management settings in the BIOS to ensure they are not the cause of the problem (see "Power" on page 47).
6. Remove all external and non-essential hardware connected to the computer that are not necessary to boot the computer to the failure point.
7. Remove any recently installed software.
8. If the Issue is still not resolved, see "Online Support Information" on page 209.

# No Display Issue

If the **Display** doesn't work, perform the following actions one at a time to correct the problem. Do not replace a non-defective FRUs:

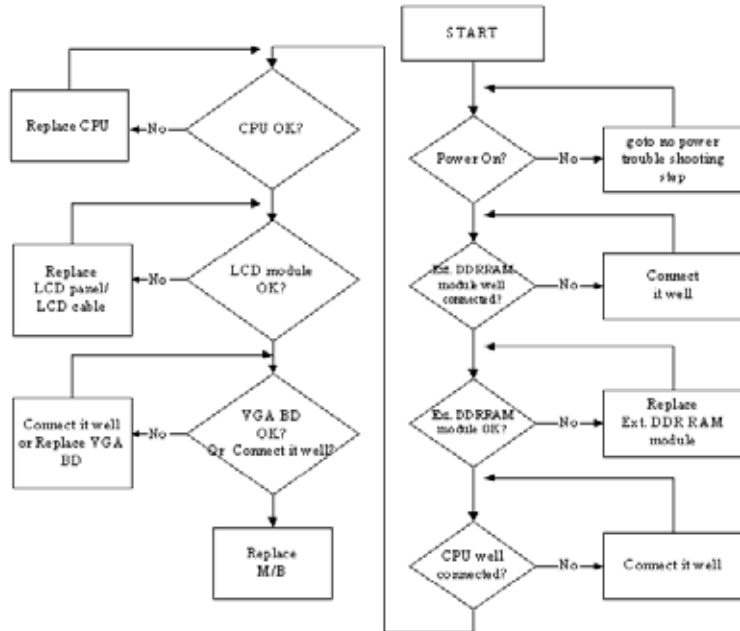

## No POST or Video

If the POST or video doesn't display, perform the following actions one at a time to correct the problem.

1. Make sure that the internal display is selected. On this notebook model, switching between the internal display and the external display is done by pressing **Fn+F5**. Reference Product pages for specific model procedures.
2. Make sure the computer has power by checking at least one of the following occurs:
  - Fans start up
  - Status LEDs light up

If there is no power, see "Power On Issue" on page 152.

3. Drain any stored power by removing the power cable and battery and holding down the power button for 10 seconds. Reconnect the power and reboot the computer.
4. Connect an external monitor to the computer and switch between the internal display and the external display is by pressing **Fn+F5** (on this model).

If the POST or video appears on the external display, see "LCD Failure" on page 155.

5. Disconnect power and all external devices including port replicators or docking stations. Remove any memory cards and CD/DVD discs. Restart the computer.

If the computer boots correctly, add the devices one by one until the failure point is discovered.

6. Reseat the memory modules.
7. Remove the drives (see "Disassembly Process" on page 58).
8. If the Issue is still not resolved, see "Online Support Information" on page 209.

---

## Abnormal Video Display

If video displays abnormally, perform the following actions one at a time to correct the problem.

1. Reboot the computer.
2. If permanent vertical/horizontal lines or dark spots display in the same location, the LCD is faulty and should be replaced. See “Disassembly Process” on page 58.
3. If extensive pixel damage is present (different colored spots in the same locations on the screen), the LCD is faulty and should be replaced. See “Disassembly Process” on page 58.
4. Adjust the brightness to its highest level. See the User Manual for instructions on adjusting settings.  
**NOTE:** Ensure that the computer is not running on battery alone as this may reduce display brightness.  
If the display is too dim at the highest brightness setting, the LCD is faulty and should be replaced. See “Disassembly Process” on page 58.
5. Check the display resolution is correctly configured:
  - a. Minimize or close all Windows.
  - b. If display size is only abnormal in an application, check the view settings and control/mouse wheel zoom feature in the application.
  - c. If desktop display resolution is not normal, right-click on the desktop and select **Personalize**→ **Display Settings**.
  - d. Click and drag the Resolution slider to the desired resolution.
  - e. Click **Apply** and check the display. Readjust if necessary.
6. Roll back the video driver to the previous version if updated.
7. Remove and reinstall the video driver.
8. Check the Device Manager to determine that:
  - The device is properly installed. There are no red Xs or yellow exclamation marks.
  - There are no device conflicts.
  - No hardware is listed under Other Devices.
9. If the Issue is still not resolved, see “Online Support Information” on page 209.
10. Run the Windows Memory Diagnostic from the operating system DVD and follow the onscreen prompts.
11. If the Issue is still not resolved, see “Online Support Information” on page 209.

## Random Loss of BIOS Settings

If the computer is experiencing intermittent loss of BIOS information, perform the following actions one at a time to correct the problem.

1. If the computer is more than one year old, replace the CMOS battery.
2. Run a complete virus scan using up-to-date software to ensure the computer is virus free.
3. If the computer is experiencing HDD or ODD BIOS information loss, disconnect and reconnect the power and data cables between devices.  
If the BIOS settings are still lost, replace the cables.
4. If HDD information is missing from the BIOS, the drive may be defective and should be replaced.
5. Replace the Motherboard.
6. If the Issue is still not resolved, see “Online Support Information” on page 209.

# LCD Failure

If the **LCD** fails, perform the following actions one at a time to correct the problem. Do not replace a non-defective FRUs:

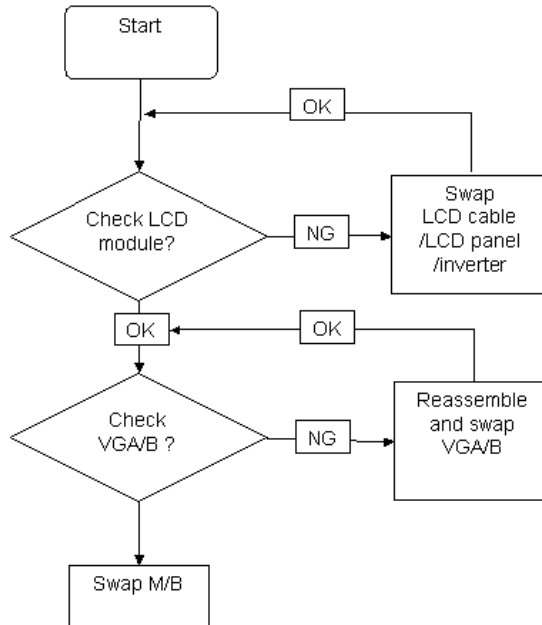

# Built-In Keyboard Failure

If the built-in **Keyboard** fails, perform the following actions one at a time to correct the problem. Do not replace a non-defective FRUs:

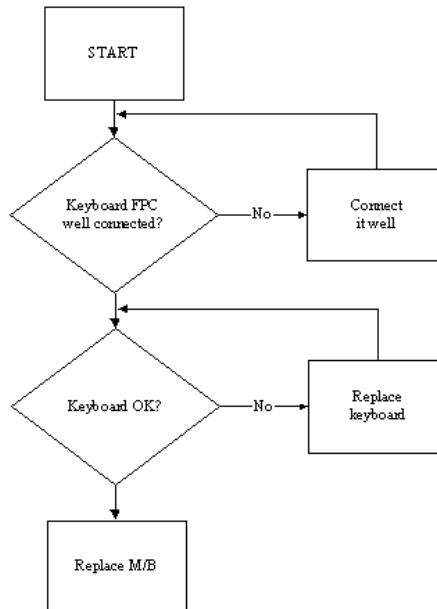

# Touch Pad Failure

If the **Touch Pad** doesn't work, perform the following actions one at a time to correct the problem. Do not replace a non-defective FRUs:

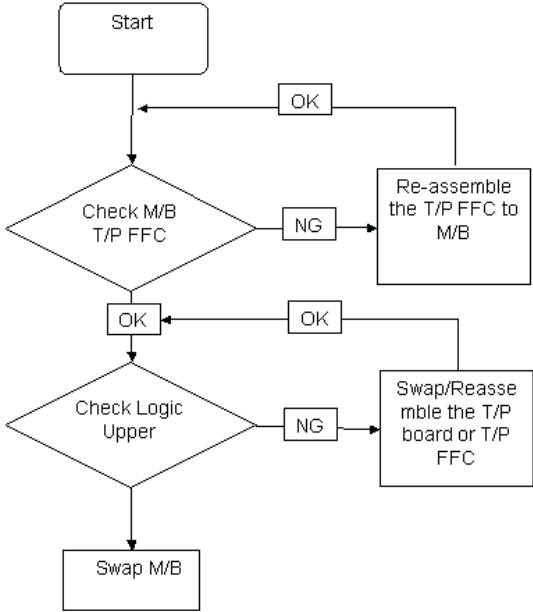

# Internal Speaker Failure

If the internal **Speakers** fail, perform the following actions one at a time to correct the problem. Do not replace a non-defective FRUs:

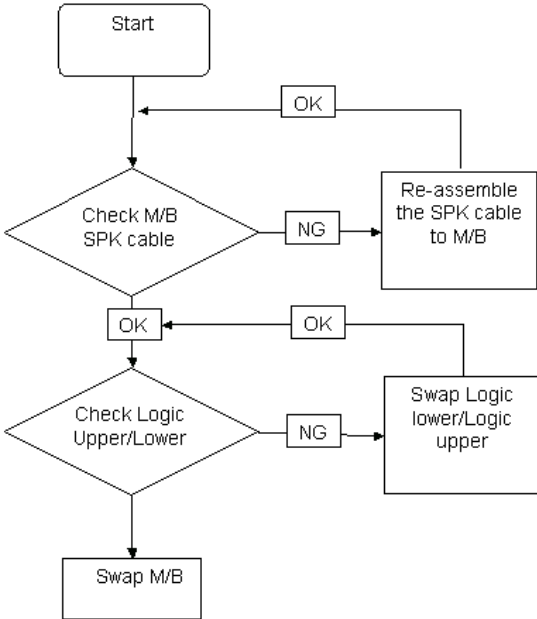

---

## Sound Problems

If sound problems are experienced, perform the following actions one at a time to correct the problem.

1. Reboot the computer.
2. Navigate to **Start** → **Control Panel** → **System and Maintenance** → **System** → **Device Manager**. Check the Device Manager to determine that:
  - The device is properly installed.
  - There are no red Xs or yellow exclamation marks.
  - There are no device conflicts.
  - No hardware is listed under Other Devices.
3. Roll back the audio driver to the previous version, if updated recently.
4. Remove and reinstall the audio driver.
5. Ensure that all volume controls are set mid range:
  - a. Click the volume icon on the taskbar and drag the slider to 50. Ensure that the volume is not muted.
  - b. Click Mixer to verify that other audio applications are set to 50 and not muted.
6. Navigate to **Start** → **Control Panel** → **Hardware and Sound** → **Sound**. Ensure that Speakers are selected as the default audio device (green check mark).

**NOTE:** If Speakers does not show, right-click on the **Playback** tab and select **Show Disabled Devices** (clear by default).
7. Select Speakers and click **Configure** to start **Speaker Setup**. Follow the onscreen prompts to configure the speakers.
8. Remove and recently installed hardware or software.
9. Restore system and file settings from a known good date using **System Restore**.

If the issue is not fixed, repeat the preceding steps and select an earlier time and date.
10. Reinstall the Operating System.
11. If the Issue is still not resolved, see “Online Support Information” on page 209.

# Internal Microphone Failure

If the internal **Microphone** fails, perform the following actions one at a time to correct the problem. Do not replace a non-defective FRUs:

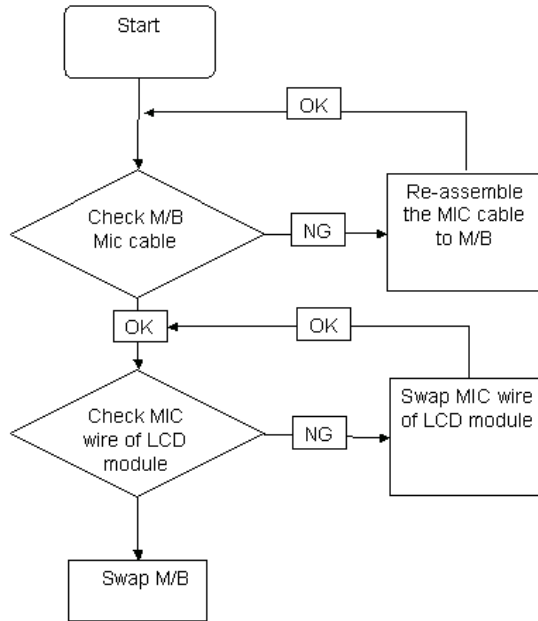

## Microphone Problems

If internal or external **Microphones** do not operate correctly, perform the following actions one at a time to correct the problem.

1. Check that the microphone is enabled. Navigate to **Start** → **Control Panel** → **Hardware and Sound** → **Sound** and select the **Recording** tab.
2. Right-click on the **Recording** tab and select **Show Disabled Devices** (clear by default).
3. The microphone appears on the **Recording** tab.
4. Right-click on the microphone and select **Enable**.
5. Select the microphone then click **Properties**. Select the **Levels** tab.
6. Increase the volume to the maximum setting and click **OK**.
7. Test the microphone hardware:
  - a. Select the microphone and click **Configure**.
  - b. Select **Set up microphone**.
  - c. Select the microphone type from the list and click **Next**.
  - d. Follow the onscreen prompts to complete the test.
8. If the Issue is still not resolved, see "Online Support Information" on page 209.



---

# HDD Not Operating Correctly

If the **HDD** does not operate correctly, perform the following actions one at a time to correct the problem.

1. Disconnect all external devices.
2. Run a complete virus scan using up-to-date software to ensure the computer is virus free.
3. Run the Windows Vista Startup Repair Utility:
  - a. insert the Windows Vista Operating System DVD in the ODD and restart the computer.
  - b. When prompted, press any key to start to the operating system DVD.
  - c. The **Install Windows** screen displays. Click **Next**.
  - d. Select **Repair your computer**.
  - e. The **System Recovery Options** screen displays. Click **Next**.
  - f. Select the appropriate operating system, and click **Next**.

**NOTE:** Click **Load Drivers** if controller drives are required.

- g. Select **Startup Repair**.
- h. Startup Repair attempts to locate and resolve issues with the computer.
- i. When complete, click **Finish**.

If an issue is discovered, follow the onscreen information to resolve the problem.

4. Run the Windows Memory Diagnostic Tool. For more information see Windows Help and Support.
5. Restart the computer and press F2 to enter the BIOS Utility. Check the BIOS settings are correct and that CD/DVD drive is set as the first boot device on the Boot menu.
6. Ensure all cables and jumpers on the HDD and ODD are set correctly.
7. Remove any recently added hardware and associated software.
8. Run the Windows Disk Defragmenter. For more information see Windows Help and Support.
9. Run Windows Check Disk by entering **chkdsk /r** from a command prompt. For more information see Windows Help and Support.
10. Restore system and file settings from a known good date using **System Restore**.

If the issue is not fixed, repeat the preceding steps and select an earlier time and date.
11. Replace the HDD. See "Disassembly Process" on page 58.

---

## ODD Failure

If the **ODD** fails, perform the following actions one at a time to correct the problem. Do not replace a non-defective FRUs:

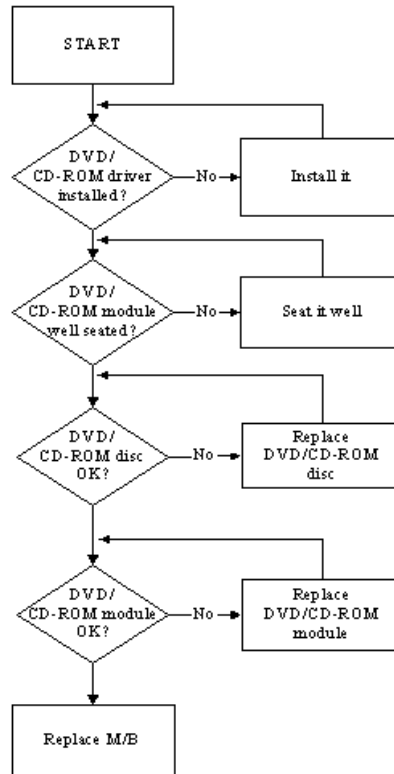

## ODD Not Operating Correctly

If the **ODD** exhibits any of the following symptoms it may be faulty:

- Audio CDs do not play when loaded
- DVDs do not play when loaded
- Blank discs do not burn correctly
- DVD or CD play breaks up or jumps
- Optical drive not found or not active:
  - Not shown in My Computer or the BIOS setup
  - LED does not flash when the computer starts up
  - The tray does not eject
- Access failure screen displays
- The ODD is noisy

Perform the following general solutions one at a time to correct the problem.

1. Reboot the computer and retry the operation.
2. Try an alternate disc.
3. Navigate to **Start** → **Computer**. Check that the ODD device is displayed in the **Devices with Removable Storage** panel.
4. Navigate to **Start** → **Control Panel** → **System and Maintenance** → **System** → **Device Manager**.

- 
- a. Double-click **IDE ATA/ATAPI controllers**. If a device displays a down arrow, right-click on the device and click **Enable**.
  - b. Double-click **DVD/CD-ROM drives**. If the device displays a down arrow, right-click on the device and click **Enable**.
  - c. Check that there are no yellow exclamation marks against the items in **IDE ATA/ATAPI controllers**. If a device has an exclamation mark, right-click on the device and uninstall and reinstall the driver.
  - d. Check that there are no yellow exclamation marks against the items in **DVD/CD-ROM drives**. If a device has an exclamation mark, right-click on the device and uninstall and reinstall the driver.
  - e. If the exclamation marker is not removed from the item in the lists, try removing any recently installed software and retrying the operation.

## Discs Do Not Play

If discs do not play when inserted in the drive, perform the following actions one at a time to correct the problem.

1. Check that the disc is correctly seated in the drive tray and that the label on the disc is visible.
2. Check that the media is clean and scratch free.
3. Try an alternate disc in the drive.
4. Ensure that **AutoPlay** is enabled:
  - a. Navigate to **Start** → **Control Panel** → **Hardware and Sound** → **AutoPlay**.
  - b. Select **Use AutoPlay for all media and devices**.
  - c. In the Audio CD and DVD Movie fields, select the desired player from the drop down menu.
5. Check that the Regional Code is correct for the selected media:

**IMPORTANT:**Region can only be changed a limited number of times. After Changes remaining reaches zero, the region cannot be changed even Windows is reinstalled or the drive is moved to another computer.

- a. Navigate to **Start** → **Control Panel** → **System and Maintenance** → **System** → **Device Manager**.
- b. Double-click **DVD/CD-ROM drives**.
- c. Right-click **DVD drive** and click **Properties**, then click the **DVD Region** tab.
- d. Select the region suitable for the media inserted in the drive.

## Discs Do Not Burn Properly

If discs can not be burned, perform the following actions one at a time to correct the problem.

1. Ensure that the default drive is record enabled:
  - a. Navigate to **Start** → **Computer** and right-click the writable ODD icon. Click **Properties**.
  - b. Select the **Recording** tab. In the **Desktop disc recording** panel, select the writable ODD from the drop down list.
  - c. Click **OK**.
2. Ensure that the software used for burning discs is the factory default. If using different software, refer to the software's user manual.

## Playback is Choppy

If playback is choppy or jumps, perform the following actions one at a time to correct the problem.

1. Check that system resources are not running low:
  - a. Try closing some applications.
  - b. Reboot and try the operation again.
2. Check that the ODD controller transfer mode is set to DMA:
  - a. Navigate to **Start** → **Control Panel** → **System and Maintenance** → **System** → **Device Manager**.

- 
- b. Double-click **IDE ATA/ATAPI controllers**, then right-click ATA Device 0.
  - c. Click **Properties** and select the **Advanced Settings** tab. Ensure that the **Enable DMA** box is checked and click **OK**.
  - d. Repeat for the other ATA Devices shown if applicable.

### Drive Not Detected

If Windows cannot detect the drive, perform the following actions one at a time to correct the problem.

1. Restart the computer and press F2 to enter the BIOS Utility.
2. Check that the drive is detected in the **ATAPI Model Name** field on the Information page.  
**NOTE:** Check that the entry is identical to one of the ODDs specified in “Hardware Specifications and Configurations” on page 31.
3. Turn off the power and remove the cover to inspect the connections to the ODD. See “Disassembly Process” on page 58.
  - a. Check for broken connectors on the drive, motherboard, and cables.
  - b. Check for bent or broken pins on the drive, motherboard, and cable connections.
  - c. Try an alternate cable, if available. If the drive works with the new cable, the original cable should be replaced.
4. Reseat the drive ensuring and all cables are connected correctly.
5. Replace the ODD. See “Disassembly Process” on page 58.

### Drive Read Failure

If discs cannot be read when inserted in the drive, perform the following actions one at a time to correct the problem.

1. Remove and clean the failed disc.
2. Retry reading the CD or DVD.
  - d. Test the drive using other discs.
  - e. Play a DVD movie
  - f. Listen to a music CD

If the ODD works properly with alternate discs, the original disc is probably defective and should be replaced.

3. Turn off the power and remove the cover to inspect the connections to the ODD. See “Disassembly Process” on page 58.
  - a. Check for broken connectors on the drive, motherboard, and cables.
  - b. Check for bent or broken pins on the drive, motherboard, and cable connections.
  - c. Try an alternate cable, if available. If the drive works with the new cable, the original cable should be replaced.
4. Replace the ODD. See “Disassembly Process” on page 58.

# USB Failure (Rightside)

If the rightside **USB** port fails, perform the following actions one at a time to correct the problem. Do not replace a non-defective FRUs:

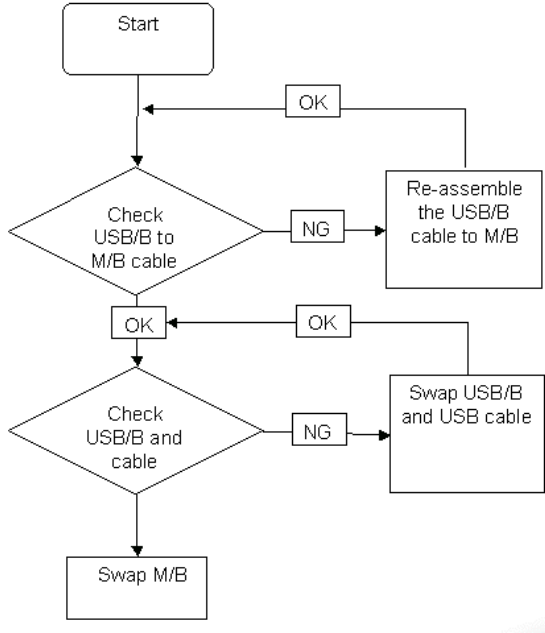

# Modem Function Failure

If the internal **Modem** fails, perform the following actions one at a time to correct the problem. Do not replace a non-defective FRUs:

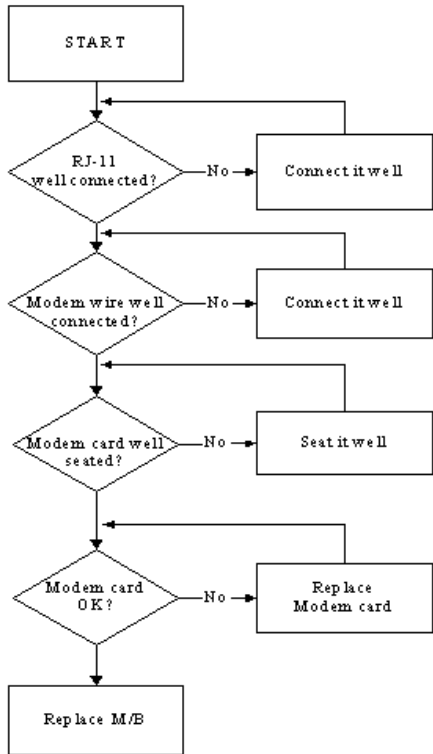

# Wireless Function Failure

If the **WLAN** fails, perform the following actions one at a time to correct the problem. Do not replace a non-defective FRUs:

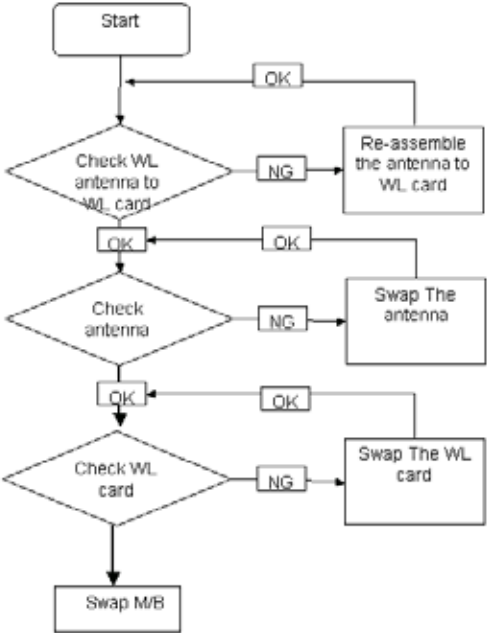

# EasyTouch Button Failure

If the **Acer EasyTouch** buttons fail, perform the following actions one at a time to correct the problem. Do not replace a non-defective FRUs:

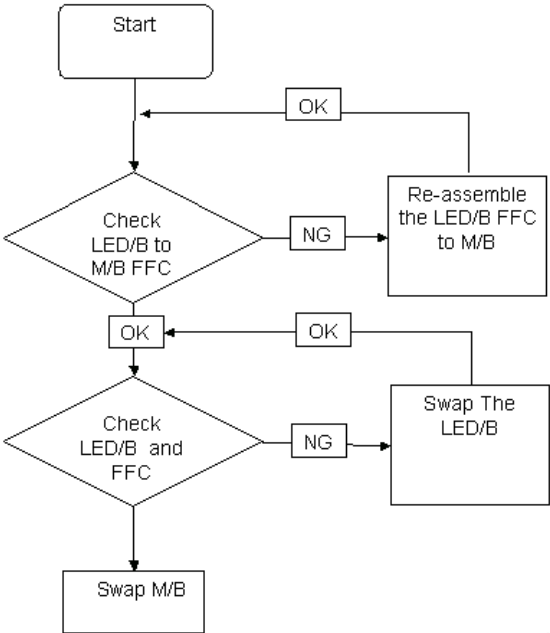

# MediaTouch Button Failure

If the **Acer MediaTouch** buttons fail, perform the following actions one at a time to correct the problem. Do not replace a non-defective FRUs:

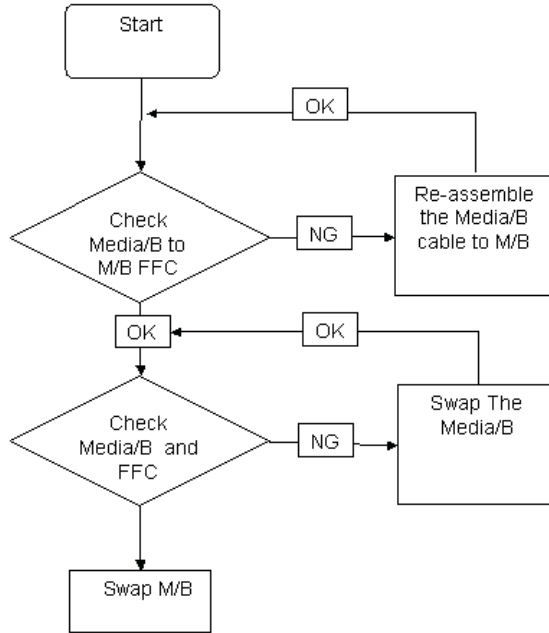

# Fingerprint Reader Failure

If the **Fingerprint Reader** fails, perform the following actions one at a time to correct the problem. Do not replace a non-defective FRUs:

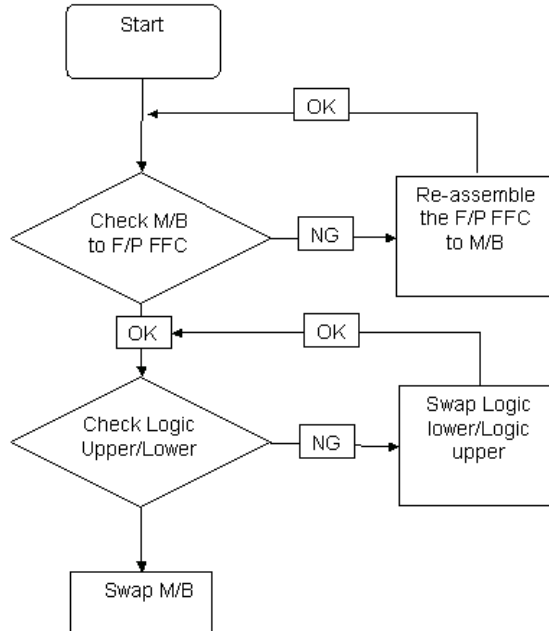

# Thermal Unit Failure

If the **Thermal Unit** fails, perform the following actions one at a time to correct the problem. Do not replace a non-defective FRUs:

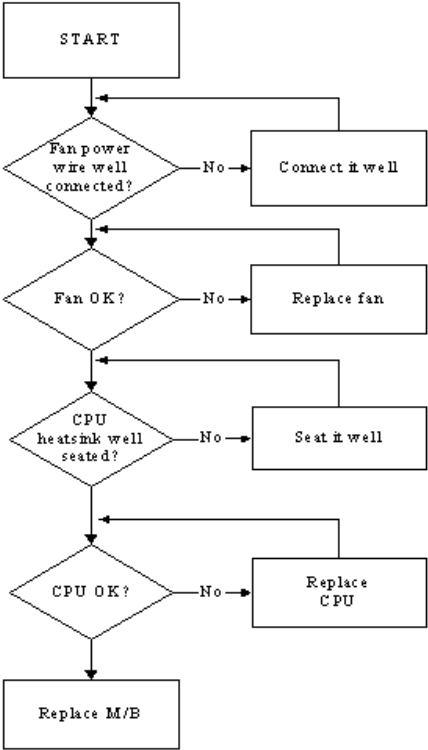

# HDTV Switch Failure

If the **HDTV Switch** fails, perform the following actions one at a time to correct the problem. Do not replace a non-defective FRUs:

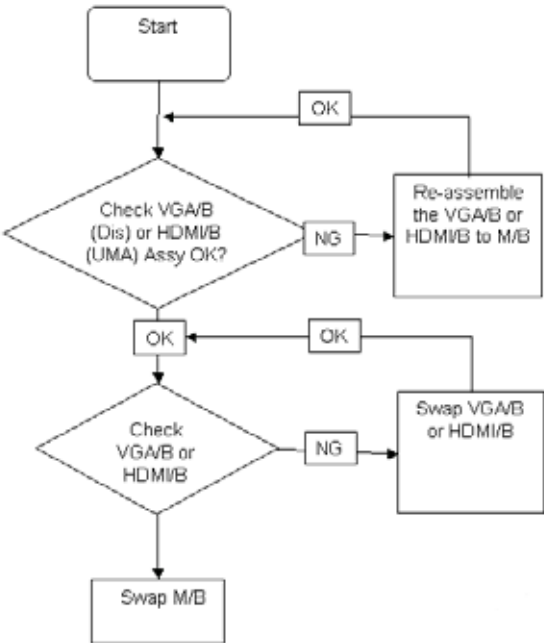



---

## External Mouse Failure

If an external **Mouse** fails, perform the following actions one at a time to correct the problem.

1. Try an alternative mouse.
2. If the mouse uses a wireless connection, insert new batteries and confirm there is a good connection. See the mouse user manual.
3. If the mouse uses a USB connection, try an alternate USB port.
4. Try an alternative program to verify mouse operation. Reinstall the program experiencing mouse failure.
5. Restart the computer.
6. Remove any recently added hardware and associated software.
7. Remove any recently added software and reboot.
8. Restore system and file settings from a known good date using **System Restore**.  
If the issue is not fixed, repeat the preceding steps and select an earlier time and date.
9. Run the Event Viewer to check the events log for errors. For more information see Windows Help and Support.
10. Roll back the mouse driver to the previous version if updated recently.
11. Remove and reinstall the mouse driver.
12. Check the Device Manager to determine that:
  - The device is properly installed. There are no red Xs or yellow exclamation marks.
  - There are no device conflicts.
  - No hardware is listed under Other Devices.
13. If the Issue is still not resolved, see "Online Support Information" on page 209.

## Other Failures

If the CRT Switch, Dock, LAN Port, external MIC or Speakers, PCI Express Card, 5-in-1 Card Reader or Volume Wheel fail, perform the following general steps to correct the problem. Do not replace a non-defective FRUs:

1. Check Drive whether is OK.
2. Check Test Fixture is ok.
3. Swap M/B to Try.

---

# Intermittent Problems

Intermittent system hang problems can be caused by a variety of reasons that have nothing to do with a hardware defect, such as: cosmic radiation, electrostatic discharge, or software errors. FRU replacement should be considered only when a recurring problem exists.

When analyzing an intermittent problem, do the following:

1. Run the advanced diagnostic test for the system board in loop mode at least 10 times.
2. If no error is detected, do not replace any FRU.
3. If any error is detected, replace the FRU. Rerun the test to verify that there are no more errors.

# Undetermined Problems

The diagnostic problems does not identify which adapter or device failed, which installed devices are incorrect, whether a short circuit is suspected, or whether the system is inoperative.

Follow these procedures to isolate the failing FRU (do not isolate non-defective FRU).

**NOTE:** Verify that all attached devices are supported by the computer.

**NOTE:** Verify that the power supply being used at the time of the failure is operating correctly. (See “Power On Issue” on page 152.):

1. Power-off the computer.
2. Visually check them for damage. If any problems are found, replace the FRU.
3. Remove or disconnect all of the following devices:
  - Non-Acer devices
  - Printer, mouse, and other external devices
  - Battery pack
  - Hard disk drive
  - DIMM
  - CD-ROM/Diskette drive Module
  - PC Cards
4. Power-on the computer.
5. Determine if the problem has changed.
6. If the problem does not recur, reconnect the removed devices one at a time until you find the failing FRU.
7. If the problem remains, replace the following FRU one at a time. Do not replace a non-defective FRU:
  - System board
  - LCD assembly

# Jumper and Connector Locations

## Top View

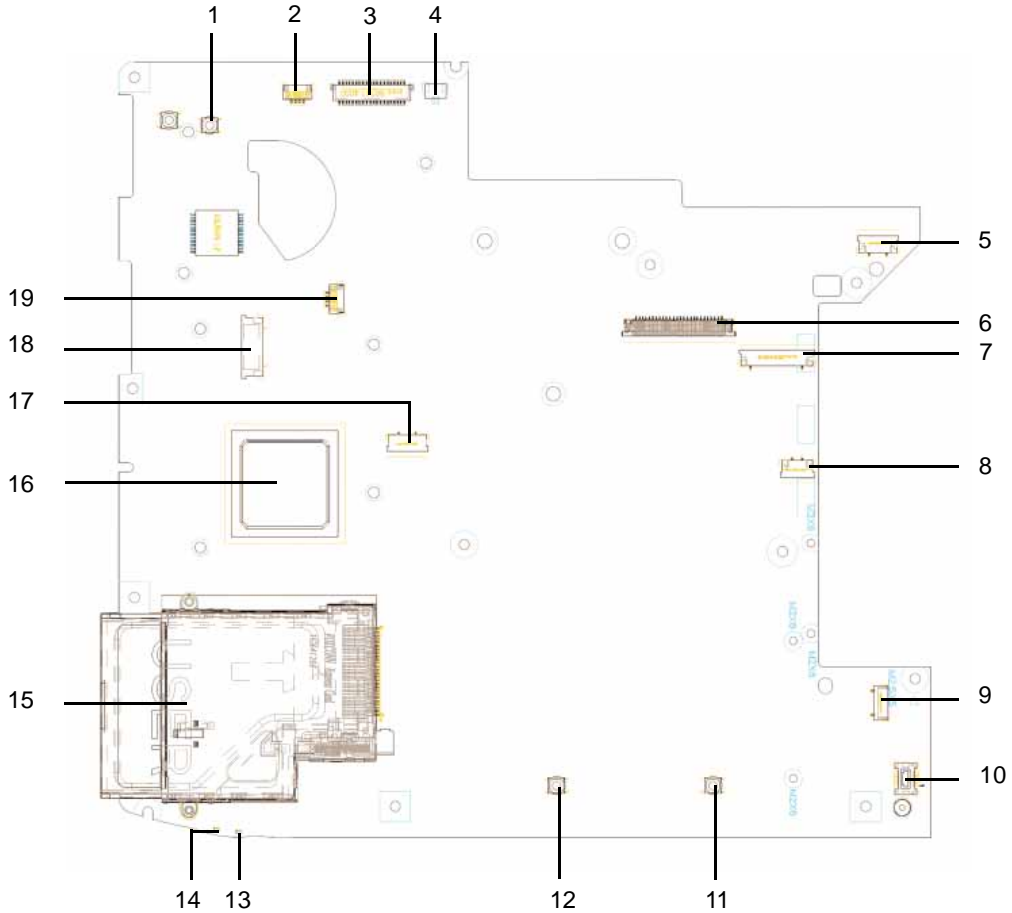

No.	Item	Description	No.	Item	Description
1	SW1	e-Key Button	11	SW3	Touch pad (right) Button
2	JP1	Digital MIC Connector	12	SW2	Touch pad (left) Button
3	JLVDS1	LCD Connector	13	LED2	Battery LED
4	JP14	Acer backlight Connector	14	LED1	Power/SUSP LED
5	JP2	Media/B Connector	15	JEXP1	Express Card Socket
6	JP4	Internal Keyboard Connector	16	U9	South Bridge
7	JP6	Power/B Connector	17	JP7	Touch Pad Connector
8	JP8	FP/B Connector	18	JP5	Fun/B Connector
9	JP10	Bluetooth Connector	19	JP3	Speaker Connector
10	JMDC1	MDC Connector			

# Bottom View

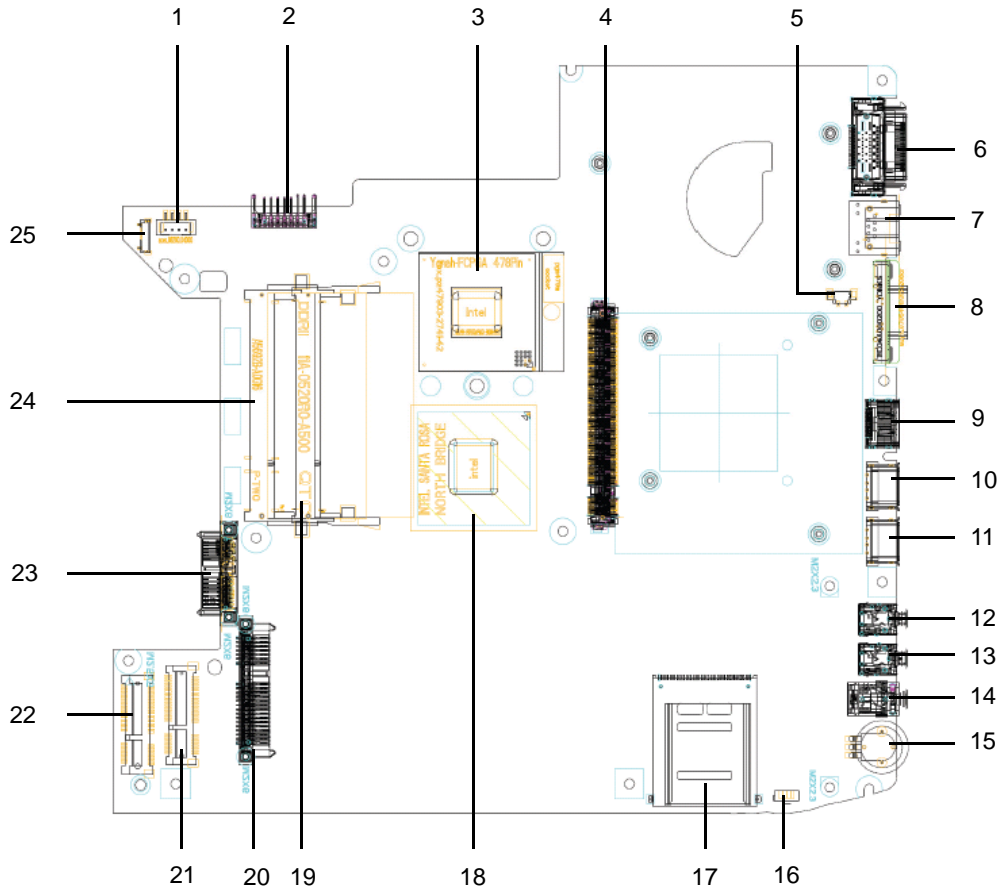

No.	Item	Description	No.	Item	Description
1	PJP1	AC-IN Connector	14	JHP1	Head-Phone Connector
2	PJP2	Battery Connector	15	U39	Volume control wheel
3	JCPU1	CPU Socket	16	IR1	IR receiver
4	JMXM1	MXM Board Connector	17	JREAD1	Card Reader Socket
5	JP12	Fan Connector	18	U31	North Bridge
6	JDOCK1	Dock Connector	19	JDIMM2	Memory DIMM2 Connector
7	JRJ45	RJ45 Connector	20	JSATA2	HDD Connector
8	JCRT1	CRT Connector	21	JMINI2	Wireless Card Connector
9	JHDMI1	HDMI Connector	22	JMINI1	Robson II Connector
10	JUSB1	USB Connector	23	JSATA1	ODD Connector
11	JUSB2	USB Connector	24	JDIMM1	Memory DIMM1 Connector
12	JLINE1	Line-In Jack	25	JP11	USB/B Connector
13	JMIC1	MIC-In Jack			

---

# Clearing Password Check and BIOS Recovery

This section provide you the standard operating procedures of clearing password and BIOS recovery for Aspire 4930. Aspire 4930 provide one Hardware Open Gap on main board for clearing password check, and one Hotkey for enabling BIOS Recovery.

## Clearing Password Check

### Hardware Open Gap Description

Item	Description
R347 (RTC_RST)	Clear CMOS Jumper



### Steps for Clearing BIOS Password Check

If users set BIOS Password (Supervisor Password and/or User Password) for a security reason, BIOS will ask the password during systems POST or when systems enter to BIOS Setup menu. However, once it is necessary to bypass the password check, users need to short the HW Gap to clear the password by the following steps:

- Power Off a system, and remove HDD, AC and Battery from the machine.
- Open the back cover of the machine, and find out the HW Gap on M/B as picture.
- Use an electric conductivity tool to short the two points of the HW Gap.
- Plug in AC, keep the short condition on the HW Gap, and press Power Button to power on the system till BIOS POST finish. Then remove the tool from the HW Gap.
- Restart system. Press F2 key to enter BIOS Setup menu.
- If there is no Password request, BIOS Password is cleared. Otherwise, please follow the steps and try again.

**NOTE:** The steps are only for clearing BIOS Password (Supervisor Password and User Password).

---

# BIOS Recovery by Crisis Disk

## BIOS Recovery Boot Block:

BIOS Recovery Boot Block is a special block of BIOS. It is used to boot up the system with minimum BIOS initialization. Users can enable this feature to restore the BIOS firmware to a successful one once the previous BIOS flashing process failed.

## BIOS Recovery Hotkey:

The system provides a function hotkey: **Fn+Esc**, for enable BIOS Recovery process when system is powered on during BIOS POST. To use this function, it is strongly recommended to have the AC adapter and Battery present. If this function is enabled, the system will force the BIOS to enter a special BIOS block, called Boot Block.

## Steps for BIOS Recovery from USB Storage:

Before doing this, prepare the Crisis USB key. The Crisis USB key could be made by executing the Crisis Disk program in another system with Windows XP OS.

Follow the steps below:

1. Save ROM file (file name: **JAL90x64.fd**) to the root directory of USB storage.
2. Plug USB storage into USB port.
3. Press **Fn + ESC** button then plug in AC.  
The Power button flashes once.
4. Press **Power** button to initiate system CRISIS mode.  
When CRISIS is complete, the system auto restarts with a workable BIOS.
5. Update the latest version BIOS for this machine by regular BIOS flashing process.

# FRU (Field Replaceable Unit) List

---

This chapter gives you the FRU (Field Replaceable Unit) listing in global configurations of Aspire 4930. Refer to this chapter whenever ordering for parts to repair or for RMA (Return Merchandise Authorization).

Please note that WHEN ORDERING FRU PARTS, you should check the most up-to-date information available on your regional web or channel. For whatever reasons a part number change is made, it will not be noted on the printed Service Guide. For ACER AUTHORIZED SERVICE PROVIDERS, your Acer office may have a DIFFERENT part number code from those given in the FRU list of this printed Service Guide. You MUST use the local FRU list provided by your regional Acer office to order FRU parts for repair and service of customer machines.

NOTE: To scrap or to return the defective parts, you should follow the local government ordinance or regulations on how to dispose it properly, or follow the rules set by your regional Acer office on how to return it.

# Aspire 4930 Exploded Diagram

## Aspire 4930 FRU List

Category	Description	Part Number
Adapter		
ADAPTER	ADAPTER 65W 3PIN DELTA SADP-65KB DFA	AP.06501.013
ADAPTER	ADAPTER 65W 3PIN LITE-ON PA-1650-02AC	AP.06503.016
ADAPTER	ADAPTER 90W 3PIN DELTA ADP-90SB BBEA	AP.09001.013
ADAPTER	ADAPTER 90W 3PIN LITE-ON PA-1900-24AR	AP.09003.011
Battery		
		
BATTERY	BATTERY LI-ION 6CELLS 4.4KAH SANYO 3S2P 4.4AH 7 043 0FA	BT.00603.041
BATTERY	BATTERY LI-ION 6CELLS 4.4KAH SONY 3S2P 4.4AH 7 043 0FA	BT.00604.024
BATTERY	BATTERY LI-ION 6CELLS 4.4KAH PANASONIC 3S2P 4.4AH 7 043 0FA	BT.00605.020
BATTERY	BATTERY LI-ION 6CELLS 4.4KAH SIMPLO LG 3S2P 4.4AH 7 043 0FA	BT.00607.019
BATTERY	BATTERY LI-ION 6CELLS 4.4KAH SIMPLO PA 3S2P 4.4AH 7 043 0FA	BT.00607.015
Board		



Category	Description	Part Number
BOARD 	MODEM BOARD	FX.22500.022
BOARD	MODEM BOARD-AUS	FX.22500.023
BOARD	MEDIA BOARD	55.AR102.001
BOARD 	MINI WLAN/B 802.11 B/G FOXCONN ATHEROS	NI.23600.007
BOARD 	BLUETOOTH BOARD	54.AR102.001
BOARD 	USB BOARD	55.AR102.002
BOARD 	POWER BOARD	55.AR102.003
BOARD 	FUNCTION BOARD	55.AR102.004
BOARD 	FINGER PRINT BOARD	55.AR102.005
BOARD	VGA BOARD-NB9M-GS	VG.9MG06.002
BOARD 	HDMI BOARD-UMA	55.AR102.006
Cables		
CABLE	RJ11 CABLE	50.AR102.001
CABLE	MEDIA BOARD FFC	50.AR102.002
CABLE	BLUETOOTH CABLE	50.AR102.003
CABLE	USB CABLE	50.AR102.004
CABLE	T/P FFC	50.AR102.005
CABLE	ANTENNA R	50.AR102.007
CABLE	ANTENNA L	50.AR102.008

Category	Description	Part Number
CABLE	POWER CORD US 3 PIN	27.TAVV5.001
CABLE	POWER CORD EU 3 PIN	27.TAVV5.002
CABLE	POWER CORD AUS 3 PIN	27.TAVV5.003
CABLE	POWER CORD UK 3 PIN	27.TAVV5.004
CABLE	POWER CORD CHINA 3 PIN	27.TAVV5.005
CABLE	POWER CORD SWISS 3 PIN	27.TAVV5.006
CABLE	POWER CORD ITALIAN 3 PIN	27.TAVV5.007
CABLE	POWER CORD DENMARK 3 PIN	27.TAVV5.008
CABLE	POWER CORD JP 3 PIN	27.TAVV5.009
CABLE	POWER CORD SOUTH AFRICA 3 PIN	27.TAVV5.010
CABLE	POWER CORD KOERA 3 PIN	27.TAVV5.011
CABLE	POWER CORD ISRAEL 3 PIN	27.TAVV5.012
CABLE	POWER CORD INDIA 3 PIN	27.TAVV5.013
CABLE	POWER CORD TWN 3 PIN	27.TAVV5.014
CABLE	POWER CORD ARGENTINA 3 PIN	27.AR102.001
Assembly Parts		
CASE/COVER/ BRACKET ASSEMBLY	MIDDLE COVER	42.AR102.001
CASE/COVER/ BRACKET ASSEMBLY	UPPER CASE ASSY W/FP FUNCTION	60.AR102.001
CASE/COVER/ BRACKET ASSEMBLY	UPPER CASE ASSY W/O FP FUNCTION	TBD
CASE/COVER/ BRACKET ASSEMBLY	LOWER CASE	60.AR102.002
CASE/COVER/ BRACKET ASSEMBLY	MEDIA BUTTON	42.AR102.002
CASE/COVER/ BRACKET ASSEMBLY	FINGER PRINT BOARD BRACKET	33.AR102.001
CASE/COVER/ BRACKET ASSEMBLY	T/P BRACKET	33.AR102.002
CASE/COVER/ BRACKET ASSEMBLY	RAM DOOR	42.AR102.003
CASE/COVER/ BRACKET ASSEMBLY	HDD DOOR	42.AR102.004
CASE/COVER/ BRACKET ASSEMBLY	MINI DOOR	42.AR102.005
CPU		
		
CPU/PROCESSOR		
CPU/PROCESSOR		
Combo Drive		
		

Category	Description	Part Number
COMBO DRIVE	DVD SUPER MULTI MODULE TRAY IN	6M.AR102.001
COMBO DRIVE	DVD SUPER MULTI DRIVE PANASONIC UJ-870A 0FA	KU.00807.059
COMBO DRIVE	DVD SUPER MULTI DRIVE PIONEER DVR-TD08RS 0FA	KU.00805.044
COMBO DRIVE	DVD SUPER MULTI DRIVE PLDS DS-8A2S 0FA	KU.0080F.001
COMBO DRIVE	DVD SUPER MULTI DRIVE SONY AD-7560S 0FA	KU.0080E.009
COMBO DRIVE	DVD SUPER MULTI DRIVE TOSHIBA TS-L633A 0FA	KU.00801.021
CASE/COVER/ BRACKET ASSEMBLY	ODD BEZEL-SUPER MULTI	42.AR102.006
CASE/COVER/ BRACKET ASSEMBLY	ODD BRACKET	33.AR102.003
COMBO DRIVE	BLUE RAY MODULE	6M.AR102.002
COMBO DRIVE	BLUE RAY DRIVE SONY DL 2X BC-5500S	KO.0020E.002
CASE/COVER/ BRACKET ASSEMBLY	ODD BEZEL-BLUE RAY	42.AR102.007
CASE/COVER/ BRACKET ASSEMBLY	ODD BRACKET	33.AR102.003
Hard Disk		
		
HDD/HARD DISK DRIVE	HDD SATA 120G 5400RPM HGST HTS542512K9SA00 0FA	KH.12007.014
HDD/HARD DISK DRIVE	HDD SATA 120G 5400RPM TOSHIBA MK1246GSX 0FA	KH.12004.007
HDD/HARD DISK DRIVE	HDD SATA 120G 5400RPM SEAGATE ST9120817AS 0FA	KH.12001.032
HDD/HARD DISK DRIVE	HDD SATA 120G 5400RPM WD WD1200BEVS-22UST0 0FA	KH.12008.019
HDD/HARD DISK DRIVE	HDD SATA 160G 5400RPM HGST HTS542516K9SA00 0FA	KH.16007.016
HDD/HARD DISK DRIVE	HDD SATA 160G 5400RPM TOSHIBA MK1646GSX 0FA	KH.16004.002
HDD/HARD DISK DRIVE	HDD SATA 160G 5400RPM SEAGATE ST9160827AS 0FA	KH.16001.029
HDD/HARD DISK DRIVE	HDD SATA 160G 5400RPM WD WD1600BEVT-22ZCT0 0FA	KH.16008.022
HDD/HARD DISK DRIVE	HDD SATA 250G 5400RPM HGST HTS542525K9SA00 0FA	KH.25007.011
HDD/HARD DISK DRIVE	HDD SATA 250G 5400RPM TOSHIBA MK2546GSX 0FA	KH.25004.001
HDD/HARD DISK DRIVE	HDD SATA 250G 5400RPM SEAGATE ST9250827AS 0FA	KH.25001.011
HDD/HARD DISK DRIVE	HDD SATA 250G 5400RPM WD WD2500BEVS-22UST0 0FA	KH.25008.018
HDD/HARD DISK DRIVE	HDD SATA 320G 5400RPM TOSHIBA MK3252GSX 0FA	KH.32004.001
HDD/HARD DISK DRIVE	HDD SATA 320G 5400RPM WD WD3200BEVT-22ZCT0 0FA	KH.32008.013
HDD/HARD DISK DRIVE	HDD SATA 320G 5400RPM HGST HTS543232L9A300 0FA	KH.32007.004

Category	Description	Part Number
HDD/HARD DISK DRIVE	HDD SATA 320G 5400RPM SEAGATE ST9320320AS 0FA	KH.32001.008
CASE/COVER/BRACKET ASSEMBLY	HDD BRACKET	33.AR102.004
Keyboard		
		
KEYBOARD	KEYBOARD INTE(UI) BLACK AS	KB.INT00.442
KEYBOARD	KEYBOARD ARABIC/ENGLISH BLACK AS	KB.INT00.474
KEYBOARD	KEYBOARD BELGIUM BLACK AS	KB.INT00.473
KEYBOARD	KEYBOARD BRAZILIAN BLACK AS	KB.INT00.472
KEYBOARD	KEYBOARD CANADIAN/FRENCH BLACK AS	KB.INT00.471
KEYBOARD	KEYBOARD CHINESE BLACK AS	KB.INT00.470
KEYBOARD	KEYBOARD CZECH BLACK AS	KB.INT00.469
KEYBOARD	KEYBOARD DENMARK BLACK AS	KB.INT00.468
KEYBOARD	KEYBOARD NETHERLANDS BLACK AS	KB.INT00.467
KEYBOARD	KEYBOARD FRENCH BLACK AS	KB.INT00.465
KEYBOARD	KEYBOARD GERMAN BLACK AS	KB.INT00.464
KEYBOARD	KEYBOARD GREEK BLACK AS	KB.INT00.463
KEYBOARD	KEYBOARD HUNGARY BLACK AS	KB.INT00.462
KEYBOARD	KEYBOARD ITALY BLACK AS	KB.INT00.459
KEYBOARD	KEYBOARD KOREAN BLACK AS	KB.INT00.457
KEYBOARD	KEYBOARD NORWEGIAN BLACK AS	KB.INT00.455
KEYBOARD	KEYBOARD PORTUGUESE BLACK AS	KB.INT00.453
KEYBOARD	KEYBOARD RUSSIAN BLACK AS	KB.INT00.452
KEYBOARD	KEYBOARD SPANISH BLACK AS	KB.INT00.449
KEYBOARD	KEYBOARD SWEDISH BLACK AS	KB.INT00.448
KEYBOARD	KEYBOARD SWITZERLAND BLACK AS	KB.INT00.447
KEYBOARD	KEYBOARD THAILAND BLACK AS	KB.INT00.446
KEYBOARD	KEYBOARD TURKISH BLACK AS	KB.INT00.445
KEYBOARD	KEYBOARD UK BLACK AS	KB.INT00.444
KEYBOARD	KEYBOARD HEBREW BLACK AS	KB.INT00.443
KEYBOARD	KEYBOARD JP BLACK AS	KB.INT00.458
KEYBOARD	KEYBOARD ARABIC/FRENCH BLACK AS	KB.INT00.475
KEYBOARD	KEYBOARD CANADIAN/ENGLISH BLACK AS	KB.INT00.477
LCD Panel		
LCD	ASSY LCD MODULE 15.4 IN. WXGA GLARE FOR CCD 0.3M W/ ANTENNA	6M.AR102.003
LCD	LCD PANEL G 14.1 WXGA AUO B141EW04 V4	LK.14105.018
LCD	LCD PANEL G 14.1 WXGA SAMSUNG LTN141W3-L01-J	LK.14106.014
LCD	LCD PANEL G 14.1 WXGA CMO N141I3-L02	LK.1410D.016
LCD	LCD PANEL G 14.1 WXGA LPL LP141WX3-TLN1	LK.14108.014
BOARD	INVERTER BOARD	19.AR102.001
CABLE	LCD CABLE	50.AR102.006

Category	Description	Part Number
CASE/COVER/ BRACKET ASSEMBLY	LCD COVER ASSY W/BACKLIGHT	60.AR102.005
CASE/COVER/ BRACKET ASSEMBLY	LCD BEZEL	60.AR102.003
CASE/COVER/ BRACKET ASSEMBLY	LCD BRACKET-R	33.AR102.005
CASE/COVER/ BRACKET ASSEMBLY	LCD BRACKET-L	33.AR102.006
DIGITAL LIGHT DEVICE	CAMERA 0.3M	57.AR102.001
DIGITAL LIGHT DEVICE	CAMERA 1.3M	57.AR102.002
CASE/COVER/ BRACKET ASSEMBLY	CAMERA BRACKET	33.AR102.007
Memory		
		
MEMORY	RAM 512MB DDRII 667 NANYA NT512T64UH8B0FN-3C	KN.51203.032
MEMORY	RAM 512MB DDRII 667 SAMSUNG M470T6464QZ3-CE6	KN.5120B.026
MEMORY	RAM 512MB DDRII 667 HYNIX HYMP164S64CP6-Y5	KN.5120G.024
MEMORY	RAM 1GB DDRII 667 NANYA NT1GT64U8HB0BN-3C	KN.1GB03.014
MEMORY	RAM 1GB DDRII 667 SAMSUNG M470T2864QZ3-CE6	KN.1GB0B.016
MEMORY	RAM 1GB DDRII 667 HYNIX HYMP112S64CP6-Y5	KN.1GB0G.012
MEMORY	RAM 1GB DDRII 667 INFINEON HYS64T128021EDL-3S-B2	KN.1GB02.036
MEMORY	RAM 2GB DDRII 667 HYNIX HYMP125S64CP8-Y5	KN.2GB0G.004
MEMORY	RAM 2GB DDRII 667 SAMSUNG M470T5663QZ3-CE6	KN.2GB0B.003
Fan		
		
FAN	FAN-UMA	23.AR102.001
Heatsink		
		
HEATSINK	CPU THERMAL MODULE NB9M-DIS	60.AQL02.001
HEATSINK	CPU THERMAL MODULE NB9P-DIS	60.AR202.001
HEATSINK	CPU THERMAL MODULE-UMA	60.AR102.004
Speaker		
		
SPEAKER	SPEAKER	23.AR102.002
SPEAKER	MIC SET	23.AR102.003
Accessory		
ACCESSORY	REMOTE CONTROLLER EN	25.AR102.001

Category	Description	Part Number
ACCESSORY	REMOTE CONTROLLER EU	25.AR102.002
ACCESSORY	REMOTE CONTROLLER TC	25.AR102.003
ACCESSORY	REMOTE CONTROLLER SC	25.AR102.004
MISCELLANEOUS	NAME PLATE-AS4930	40.AR102.001

#### Screw List

Category	Description	Quantity	Part Number
Screw List			
SCREW	SCREW M2.5*8(NL)	15	86.AR102.001
SCREW	SCREW M2.5*5(NL)	22	86.AR102.002
SCREW	SCREW M2.5*3(NL)	2	86.AR102.003
SCREW	SCREW M2*3(NL)	31	86.AR102.003
SCREW	SCREW M2*2.3(NL)	0	86.AR102.005
SCREW	SCREW M2.5*4(NL)	2	86.AR102.006
SCREW	SCREW M2*6(NL)	0	86.AR102.007
SCREW	SCREW M2*4(NL)	5	86.AR102.006
SCREW	SCREW M3*3(NL)	0	86.AR102.009
SCREW	SCREW M2*6.5	0	86.AR102.010
SCREW	SCREW M2*3.2	0	86.AR102.011
SCREW	SCREW M2.5*6.5	0	86.AR102.012



# Model Definition and Configuration

## Aspire 4930 Series

Model	RO	Country	Acer Part no	Description	CPU	LCD	DIMM 1	DIMM 2	HDD 1 (GB)	ODD	Wireless LAN	Bluetooth	VOIP Phone
AS5051ANW XMi	AAP	India	LX.AV30C.002	AS5051AN WXMi LINPUSIL1 UMAC 1*512/80/6L/5R/ CB_bg_0.3 C_AN	ATMK36	N14.1 WXGAG	SO512 MBI15	N	N80G B5.4K	NSM8 X	ABT_ATH54 13BG	N	N
AS5051ANW XMi	AAP	Indonesia	LX.AV30C.003	AS5051AN WXMi LINPUSIN1 UMAC 1*512/80/6L/5R/ CB_bg_0.3 C_AN	ATMK36	N14.1 WXGAG	SO512 MBI15	N	N80G B5.4K	NSM8 X	ABT_ATH54 13BG	N	N
AS5051ANW XMi	AAP	Malaysia	LX.AV30C.005	AS5051AN WXMi LINPUSMA2 UMAC 1*512/80/6L/5R/ CB_bg_0.3 C_AN	ATMK36	N14.1 WXGAG	SO512 MBI15	N	N80G B5.4K	NSM8 X	ABT_ATH54 13BG	N	N
AS5051ANW XMi	AAP	Philippines	LX.AV30C.004	AS5051AN WXMi LINPUSPH1 UMAC 1*512/80/6L/5R/ CB_bg_0.3 C_AN	ATMK36	N14.1 WXGAG	SO512 MBI15	N	N80G B5.4K	NSM8 X	ABT_ATH54 13BG	N	N
AS5051ANW XMi	AAP	Singapore	LX.AV30C.001	AS5051AN WXMi LINPUSSG1 UMAC 1*512/80/6L/5R/ CB_bg_0.3 C_AN	ATMK36	N14.1 WXGAG	SO512 MBI15	N	N80G B5.4K	NSM8 X	ABT_ATH54 13BG	N	N
AS5051ANW XMi	AAP	Thailand	LX.AV30C.006	AS5051AN WXMi LINPUSTH2 UMAC 1*512/80/6L/5R/ CB_bg_0.3 C_AN	ATMK36	N14.1 WXGAG	SO512 MBI15	N	N80G B5.4K	NSM8 X	ABT_ATH54 13BG	N	N
AS5051ANW XMi	AAP	Vietnam	LX.AV30C.007	AS5051AN WXMi LINPUSVN1 UMAC 1*512/80/6L/5R/ CB_bg_0.3 C_AN	ATMK36	N14.1 WXGAG	SO512 MBI15	N	N80G B5.4K	NSM8 X	ABT_ATH54 13BG	N	N



Model	RO	Country	Acer Part no	Description	CPU	LCD	DIMM 1	DIMM 2	HDD 1 (GB)	ODD	Wireless LAN	Bluetooth	VOIP Phone
AS5051AWX Mi	PA	USA/ Canada - Canadian French	LX.AV 30J.00 1	AS5051AW XMi MCECF UMAC 2*512/120/ 6L/5R/ CB_bg_0.3 C_AN	ATMK 36	N14.1 WXGA G	SO512 MBII5	SO512 MBII5	N120 GB5.4 K	NSM8 X	ABT_ATH54 13BG	N	N
AS5051AWX Mi	PA	USA/ Canada - Canadian French	LX.AV 30J.00 2	AS5051AW XMi MCEUS UMAC 2*512/120/ 6L/5R/ CB_bg_0.3 C_AN	ATMK 36	N14.1 WXGA G	SO512 MBII5	SO512 MBII5	N120 GB5.4 K	NSM8 X	ABT_ATH54 13BG	N	N
AS5051AWX Mi	AAP	Australia/ New Zealand	LX.AV 305.00 1	AS5051AW XMi XPHAU1 UMAC 1*512/120/ 6L/5R/ CB_bg_0.3 C_AN	ATMK 36	N14.1 WXGA G	SO512 MBII5	N	N120 GB5.4 K	NSM8 X	ABT_ATH54 13BG	N	N
AS5051AWX Mi	PA	USA/ Canada	LX.AV 305.00 8	AS5051AW XMi XPHEN1 UMAC 1*512/120/ 6L/5R/ CB_bg_0.3 C_AN	ATMK 36	N14.1 WXGA G	SO512 MBII5	N	N120 GB5.4 K	NSM8 X	ABT_ATH54 13BG	N	N
AS5051AWX Mi	PA	ACLA-Spanish	LX.AV 305.01 0	AS5051AW XMi XPHES1 UMAC 1*512/120/ 6L/5R/ CB_bg_0.3 C_AN	ATMK 36	N14.1 WXGA G	SO512 MBII5	N	N120 GB5.4 K	NSM8 X	ABT_ATH54 13BG	N	N
AS5051AWX Mi	PA	USA/ Canada	LX.AV 305.00 9	AS5051AW XMi XPHFR1 UMAC 1*512/120/ 6L/5R/ CB_bg_0.3 C_AN	ATMK 36	N14.1 WXGA G	SO512 MBII5	N	N120 GB5.4 K	NSM8 X	ABT_ATH54 13BG	N	N
AS5051AWX Mi	AAP	Indonesia	LX.AV 305.00 7	AS5051AW XMi XPHIN1 UMAC 1*512/120/ 6L/5R/ CB_bg_0.3 C_AN	ATMK 36	N14.1 WXGA G	SO512 MBII5	N	N120 GB5.4 K	NSM8 X	ABT_ATH54 13BG	N	N
AS5051AWX Mi	AAP	Malaysia	LX.AV 305.00 3	AS5051AW XMi XPHMA2 UMAC 1*512/120/ 6L/5R/ CB_bg_0.3 C_AN	ATMK 36	N14.1 WXGA G	SO512 MBII5	N	N120 GB5.4 K	NSM8 X	ABT_ATH54 13BG	N	N
AS5051AWX Mi	AAP	Philippines	LX.AV 305.00 2	AS5051AW XMi XPHPH1 UMAC 1*512/120/ 6L/5R/ CB_bg_0.3 C_AN	ATMK 36	N14.1 WXGA G	SO512 MBII5	N	N120 GB5.4 K	NSM8 X	ABT_ATH54 13BG	N	N

Model	RO	Country	Acer Part no	Description	CPU	LCD	DIMM 1	DIMM 2	HDD 1 (GB)	ODD	Wireless LAN	Bluetooth	VOIP Phone
AS5051AWX Mi	AAP	Thailand	LX.AV 305.004	AS5051AW XMi XPTH2 UMAC 1*512/120/6L/5R/ CB_bg_0.3 C_AN	ATMK 36	N14.1 WXGAG	SO512 MBII5	N	N120 GB5.4 K	NSM8 X	ABT_ATH54 13BG	N	N
AS5051AWX Mi	AAP	Vietnam	LX.AV 305.005	AS5051AW XMi XPHVN1 UMAC 1*512/120/6L/5R/ CB_bg_0.3 C_AN	ATMK 36	N14.1 WXGAG	SO512 MBII5	N	N120 GB5.4 K	NSM8 X	ABT_ATH54 13BG	N	N
AS5051AWX Mi	AAP	Singapore	LX.AV 305.006	AS5051AW XMi XPHWSG2 1W UMAC 1*512/120/6L/5R/ CB_bg_0.3 C_AN	ATMK 36	N14.1 WXGAG	SO512 MBII5	N	N120 GB5.4 K	NSM8 X	ABT_ATH54 13BG	N	N
AS5051AWX Mi	PA	ACLA-Portuguese	LX.AV 305.011	AS5051AW XMi XPHXC1 UMAC 1*512/120/6L/5R/ CB_bg_0.3 C_AN	ATMK 36	N14.1 WXGAG	SO512 MBII5	N	N120 GB5.4 K	NSM8 X	ABT_ATH54 13BG	N	N
AS5051AWX Mi	TWN	GCTWN	S2.AV 305.001	AS5051AW XMi XPHTC1 UMAC 2*512/120/ BT/6L/5R/ CB_bg_0.3 C_AN	ATMK 36	N14.1 WXGAG	SO512 MBII6	SO512 MBII6	N120 GB5.4 K	NSM8 X	ABT_ATH54 13BG	FOX_BRM_2.0	N
AS5052WXM i	TWN	GCTWN	S2.AV 305.002	AS5052WX Mi XPHTC1 UMAC 2*512/100/ BT/6L/5R/ CB_bg_0.3 C_AN	ATTL50	N14.1 WXGAG	SO512 MBII6	SO512 MBII6	N100 GB5.4 K	NSM8 X	ABT_ATH54 13BG	FOX_BRM_2.0	N
AS5055WXM i	TWN	GCTWN	S2.AV 305.003	AS5055WX Mi XPHTC1 UMAC 2*1G/160/ BT/6L/5R/ CB_bg_0.3 C_AN	ATTL60	N14.1 WXGAG	SO1G BII5	SO1G BII5	N160 GB5.4 KS	NSM8 X	ABT_BRM4 318BG	FOX_BRM_2.0	N
AS5051AWX Ci	China	Hong Kong	LX.AV 305.016	AS5051AW XCi XPHHK9 UMAC 1*512/120/6L/5R/ CB_bg_0.3 C_AN	ATMK 36	N14.1 WXGAG	SO512 MBII5	N	N120 GB5.4 K	NCB2 4X	ABT_ATH54 13BG	N	N
AS5051AWX Ci	China	China	LX.AV 305.015	AS5051AW XCi XPHSC7 UMAC 1*512/120/6L/5R/ CB_bg_0.3 C_AN	ATMK 36	N14.1 WXGAG	SO512 MBII5	N	N120 GB5.4 K	NCB2 4X	ABT_ATH54 13BG	N	N

Model	RO	Country	Acer Part no	Description	CPU	LCD	DIMM 1	DIMM 2	HDD 1 (GB)	ODD	Wireless LAN	Bluetooth	VOIP Phone
AS5051AWX Mi	TWN	GCTWN	LX.AV 305.01 2	AS5051AW XMi XPHTC1 UMAC 1*512/120/ BT/6L/5R/ CB_bg_0.3 C_AN	ATMK 36	N14.1 WXGAG	SO512 MBII5	N	N120 GB5.4 K	NSM8 X	ABT_ATH54 13BG	FOX_BRM_2.0	N
AS5051AWX Mi	TWN	GCTWN	LX.AV 305.01 4	AS5051AW XMi XPHTC1 UMAC 1*512/60/ BT/6L/5R/ CB_bg_0.3 C_AN	ATMK 36	N14.1 WXGAG	SO512 MBII5	N	N60G B5.4K	NSM8 X	ABT_ATH54 13BG	FOX_BRM_2.0	N
AS5051AWX Mi	TWN	GCTWN	LX.AV 305.01 3	AS5051AW XMi XPHTC1 UMAC 1*512/80/ BT/6L/5R/ CB_bg_0.3 C_AN	ATMK 36	N14.1 WXGAG	SO512 MBII5	N	N80G B5.4K	NSM8 X	ABT_ATH54 13BG	FOX_BRM_2.0	N
AS5051AWX Mi	AAP	Australia/ New Zealand	LX.AV 30J.01 1	AS5051AW XMi MCEAU1 UMAC 1*1G/120/ 6L/5R/ CB_bg_0.3 C_AN	ATMK 36	N14.1 WXGAG	SO1G BII6	N	N120 GB5.4 K	NSM8 X	ABT_ATH54 13BG	N	N
AS5051AWX Mi	AAP	Singapore	LX.AV 30J.01 2	AS5051AW XMi MCESG1 UMAC 1*1G/120/ 6L/5R/ CB_bg_0.3 C_AN	ATMK 36	N14.1 WXGAG	SO1G BII6	N	N120 GB5.4 K	NSM8 X	ABT_ATH54 13BG	N	N
AS5051AWX Mi	AAP	India	LX.AV 30J.01 3	AS5051AW XMi MCEIL1 UMAC 1*1G/120/ 6L/5R/ CB_bg_0.3 C_AN	ATMK 36	N14.1 WXGAG	SO1G BII6	N	N120 GB5.4 K	NSM8 X	ABT_ATH54 13BG	N	N
AS5051AWX Mi	AAP	Indonesia	LX.AV 30J.01 4	AS5051AW XMi MCEIN1 UMAC 1*1G/120/ 6L/5R/ CB_bg_0.3 C_AN	ATMK 36	N14.1 WXGAG	SO1G BII6	N	N120 GB5.4 K	NSM8 X	ABT_ATH54 13BG	N	N
AS5051AWX Mi	AAP	Philippines	LX.AV 30J.01 5	AS5051AW XMi MCEPH1 UMAC 1*1G/120/ 6L/5R/ CB_bg_0.3 C_AN	ATMK 36	N14.1 WXGAG	SO1G BII6	N	N120 GB5.4 K	NSM8 X	ABT_ATH54 13BG	N	N
AS5051AWX Mi	AAP	Malaysia	LX.AV 30J.01 6	AS5051AW XMi MCEMA1 UMAC 1*1G/120/ 6L/5R/ CB_bg_0.3 C_AN	ATMK 36	N14.1 WXGAG	SO1G BII6	N	N120 GB5.4 K	NSM8 X	ABT_ATH54 13BG	N	N

Model	RO	Country	Acer Part no	Description	CPU	LCD	DIMM 1	DIMM 2	HDD 1 (GB)	ODD	Wireless LAN	Bluetooth	VOIP Phone
AS5051AWX Mi	AAP	Thailand	LX.AV 30J.017	AS5051AW XMi MCETH1 UMAC 1*1G/120/6L/5R/ CB_bg_0.3 C_AN	ATMK 36	N14.1 WXGAG	SO1G BII6	N	N120 GB5.4 K	NSM8 X	ABT_ATH54 13BG	N	N
AS5051AWX Mi	AAP	Vietnam	LX.AV 30J.018	AS5051AW XMi MCEVN1 UMAC 1*1G/120/6L/5R/ CB_bg_0.3 C_AN	ATMK 36	N14.1 WXGAG	SO1G BII6	N	N120 GB5.4 K	NSM8 X	ABT_ATH54 13BG	N	N
AS5051AWX Mi	AAP	Australia/ New Zealand	LX.AV 306.002	AS5051AW XMi XPPAU1 UMAC 1*1G/120/6L/5R/ CB_bg_0.3 C_AN	ATMK 36	N14.1 WXGAG	SO1G BII6	N	N120 GB5.4 K	NSM8 X	ABT_ATH54 13BG	N	N
AS5052WXM i	AAP	Australia/ New Zealand	LX.AV 30J.003	AS5052WXM i MCEAU1 UMAC 1*1G/120/6L/5R/ CB_bg_0.3 C_AN	ATTL5 0	N14.1 WXGAG	SO1G BII6	N	N120 GB5.4 K	NSM8 X	ABT_ATH54 13BG	N	N
AS5052WXM i	AAP	India	LX.AV 30J.005	AS5052WXM i MCEIL1 UMAC 1*1G/120/6L/5R/ CB_bg_0.3 C_AN	ATTL5 0	N14.1 WXGAG	SO1G BII6	N	N120 GB5.4 K	NSM8 X	ABT_ATH54 13BG	N	N
AS5052WXM i	AAP	Indonesia	LX.AV 30J.006	AS5052WXM i MCEIN1 UMAC 1*1G/120/6L/5R/ CB_bg_0.3 C_AN	ATTL5 0	N14.1 WXGAG	SO1G BII6	N	N120 GB5.4 K	NSM8 X	ABT_ATH54 13BG	N	N
AS5052WXM i	AAP	Singapore	LX.AV 30J.004	AS5052WXM i MCESG1 UMAC 1*1G/120/6L/5R/ CB_bg_0.3 C_AN	ATTL5 0	N14.1 WXGAG	SO1G BII6	N	N120 GB5.4 K	NSM8 X	ABT_ATH54 13BG	N	N
AS5052WXM i	AAP	Philippines	LX.AV 30J.007	AS5052WXM i MCEPH1 UMAC 1*1G/120/6L/5R/ CB_bg_0.3 C_AN	ATTL5 0	N14.1 WXGAG	SO1G BII6	N	N120 GB5.4 K	NSM8 X	ABT_ATH54 13BG	N	N
AS5052WXM i	AAP	Malaysia	LX.AV 30J.008	AS5052WXM i MCEMA1 UMAC 1*1G/120/6L/5R/ CB_bg_0.3 C_AN	ATTL5 0	N14.1 WXGAG	SO1G BII6	N	N120 GB5.4 K	NSM8 X	ABT_ATH54 13BG	N	N

Model	RO	Country	Acer Part no	Description	CPU	LCD	DIMM 1	DIMM 2	HDD 1 (GB)	ODD	Wireless LAN	Bluetooth	VOIP Phone
AS5052WXM i	AAP	Thailand	LX.AV30J.009	AS5052WXM i MCETH1 UMAC 1*1G/120/ 6L/5R/ CB_bg_0.3 C_AN	ATTL50	N14.1 WXGA G	SO1G BII6	N	N120 GB5.4 K	NSM8 X	ABT_ ATH54 13BG	N	N
AS5052WXM i	AAP	Vietnam	LX.AV30J.010	AS5052WXM i MCEVN1 UMAC 1*1G/120/ 6L/5R/ CB_bg_0.3 C_AN	ATTL50	N14.1 WXGA G	SO1G BII6	N	N120 GB5.4 K	NSM8 X	ABT_ ATH54 13BG	N	N
AS5052WXM i	AAP	Australia/ New Zealand	LX.AV306.001	AS5052WXM i XPPAU1 UMAC 1*1G/120/ 6L/5R/ CB_bg_0.3 C_AN	ATTL50	N14.1 WXGA G	SO1G BII6	N	N120 GB5.4 K	NSM8 X	ABT_ ATH54 13BG	N	N
AS5051ANW XM i	AAP	India	LX.AV30C.015	AS5051ANW XM i LINPUSIL1 UMAC 1*256/60/ 6L/5R/ CB_bg_0.3 C_AN	ATMK36	N14.1 WXGA G	SO256 MBII5	N	N60G B5.4K	NSM8 X	ABT_ ATH54 13BG	N	N
AS5051ANW XM i	AAP	Vietnam	LX.AV30C.014	AS5051ANW XM i LINPUSVN1 UMAC 1*512/60/ 6L/5R/ CB_bg_0.3 C_AN	ATMK36	N14.1 WXGA G	SO512 MBII5	N	N60G B5.4K	NSM8 X	ABT_ ATH54 13BG	N	N
AS5051ANW XM i	AAP	Thailand	LX.AV30C.016	AS5051ANW XM i LINPUSH2 UMAC 1*512/80/ BT/6L/5R/ CB_bg_0.3 C_AN	ATMK36	N14.1 WXGA G	SO512 MBII5	N	N80G B5.4K	NSM8 X	ABT_ ATH54 13BG	FOX_ BRM_ 2.0	N
AS5051ANW XM i	AAP	Singapore	LX.AV30C.008	AS5051ANW XM i LINPUSSG1 UMAC 1*512/60/ 6L/5R/ CB_bg_0.3 C_AN	ATMK36	N14.1 WXGA G	SO512 MBII5	N	N60G B5.4K	NSM8 X	ABT_ ATH54 13BG	N	N
AS5051ANW XM i	AAP	India	LX.AV30C.009	AS5051ANW XM i LINPUSIL1 UMAC 1*512/60/ 6L/5R/ CB_bg_0.3 C_AN	ATMK36	N14.1 WXGA G	SO512 MBII5	N	N60G B5.4K	NSM8 X	ABT_ ATH54 13BG	N	N
AS5051ANW XM i	AAP	Indonesia	LX.AV30C.010	AS5051ANW XM i LINPUSIN1 UMAC 1*512/60/ 6L/5R/ CB_bg_0.3 C_AN	ATMK36	N14.1 WXGA G	SO512 MBII5	N	N60G B5.4K	NSM8 X	ABT_ ATH54 13BG	N	N

Model	RO	Country	Acer Part no	Description	CPU	LCD	DIMM 1	DIMM 2	HDD 1 (GB)	ODD	Wireless LAN	Bluetooth	VOIP Phone
AS5051ANW XMi	AAP	Philippines	LX.AV 30C.0 11	AS5051AN WXMi LINPUSPH 1 UMAC 1*512/60/6L/5R/ CB_bg_0.3 C_AN	ATMK 36	N14.1 WXGAG	SO512 MBII5	N	N60G B5.4K	NSM8 X	ABT_ATH54 13BG	N	N
AS5051ANW XMi	AAP	Malaysia	LX.AV 30C.0 12	AS5051AN WXMi LINPUSMA 2 UMAC 1*512/60/6L/5R/ CB_bg_0.3 C_AN	ATMK 36	N14.1 WXGAG	SO512 MBII5	N	N60G B5.4K	NSM8 X	ABT_ATH54 13BG	N	N
AS5051ANW XMi	AAP	Thailand	LX.AV 30C.0 13	AS5051AN WXMi LINPUSTH 2 UMAC 1*512/60/6L/5R/ CB_bg_0.3 C_AN	ATMK 36	N14.1 WXGAG	SO512 MBII5	N	N60G B5.4K	NSM8 X	ABT_ATH54 13BG	N	N
AS5052WXM i	AAP	Thailand	LX.AV 30J.01 9	AS5052WXM i MCETH1 UMAC 1*1G/120/ BT/6L/5R/ CB_bg_0.3 C_AN	ATTL5 0	N14.1 WXGAG	SO1G BII6	N	N120 GB5.4 K	NSM8 X	ABT_ATH54 13BG	FOX_ BRM_ 2.0	N
AS5051AWX Mi	EMEA	Belgium	LX.AV 30J.03 2	AS5051AW XMi MCEBE6 UMAC 2*512/100/ 6L/ 5R_bg_0.3 C_AN	ATMK 36	N14.1 WXGAG	SO512 MBII6	SO512 MBII6	N100 GB5.4 K	NSM8 X	ABT_ BRM4 318BG	N	N
AS5051AWX Mi	EMEA	Middle East	LX.AV 30J.04 3	AS5051AW XMi MCEAR1 UMAC 2*512/100/ 6L/ 5R_bg_0.3 C_AN	ATMK 36	N14.1 WXGAG	SO512 MBII6	SO512 MBII6	N100 GB5.4 K	NSM8 X	ABT_ BRM4 318BG	N	N
AS5051AWX Mi	EMEA	Middle East	LX.AV 30J.04 4	AS5051AW XMi MCEAR2 UMAC 2*512/100/ 6L/ 5R_bg_0.3 C_AN	ATMK 36	N14.1 WXGAG	SO512 MBII6	SO512 MBII6	N100 GB5.4 K	NSM8 X	ABT_ BRM4 318BG	N	N
AS5051AWX Mi	EMEA	Italy	LX.AV 30J.04 0	AS5051AW XMi MCEIT7 UMAC 2*512/100/ 6L/ 5R_bg_0.3 C_AN	ATMK 36	N14.1 WXGAG	SO512 MBII6	SO512 MBII6	N100 GB5.4 K	NSM8 X	ABT_ BRM4 318BG	N	N
AS5051AWX Mi	EMEA	Spain	LX.AV 30J.03 9	AS5051AW XMi MCEESJ UMAC 2*512/100/ 6L/ 5R_bg_0.3 C_AN	ATMK 36	N14.1 WXGAG	SO512 MBII6	SO512 MBII6	N100 GB5.4 K	NSM8 X	ABT_ BRM4 318BG	N	N

Model	RO	Country	Acer Part no	Description	CPU	LCD	DIMM 1	DIMM 2	HDD 1 (GB)	ODD	Wireless LAN	Bluetooth	VOIP Phone
AS5051AWX Mi	EMEA	Eastern Europe	LX.AV 30J.030	AS5051AW XMi MCECS5 UMAC 2*512/100/6L/ 5R_bg_0.3 C_AN	ATMK 36	N14.1 WXGA	SO512 MBII6	SO512 MBII6	N100 GB5.4 K	NSM8 X	ABT_BRM4 318BG	N	N
AS5051AWX Mi	EMEA	Denmark	LX.AV 30J.024	AS5051AW XMi MCEDK6 UMAC 2*512/100/6L/ 5R_bg_0.3 C_AN	ATMK 36	N14.1 WXGA	SO512 MBII6	SO512 MBII6	N100 GB5.4 K	NSM8 X	ABT_BRM4 318BG	N	N
AS5051AWX Mi	EMEA	France	LX.AV 30J.025	AS5051AW XMi MCEFRF UMAC 2*512/100/6L/ 5R_bg_0.3 C_AN	ATMK 36	N14.1 WXGA	SO512 MBII6	SO512 MBII6	N100 GB5.4 K	NSM8 X	ABT_BRM4 318BG	N	N
AS5051AWX Mi	EMEA	Germany	LX.AV 30J.027	AS5051AW XMi MCEDEA UMAC 2*512/100/6L/ 5R_bg_0.3 C_AN	ATMK 36	N14.1 WXGA	SO512 MBII6	SO512 MBII6	N100 GB5.4 K	NSM8 X	ABT_BRM4 318BG	N	N
AS5051AWX Mi	EMEA	Germany	LX.AV 30J.028	AS5051AW XMi MCEDEB UMAC 2*512/100/6L/ 5R_bg_0.3 C_AN	ATMK 36	N14.1 WXGA	SO512 MBII6	SO512 MBII6	N100 GB5.4 K	NSM8 X	ABT_BRM4 318BG	N	N
AS5051AWX Mi	EMEA	Holland	LX.AV 30J.033	AS5051AW XMi MCENL6 UMAC 2*512/100/6L/ 5R_bg_0.3 C_AN	ATMK 36	N14.1 WXGA	SO512 MBII6	SO512 MBII6	N100 GB5.4 K	NSM8 X	ABT_BRM4 318BG	N	N
AS5051AWX Mi	EMEA	Norway	LX.AV 30J.034	AS5051AW XMi MCENO5 UMAC 2*512/100/6L/ 5R_bg_0.3 C_AN	ATMK 36	N14.1 WXGA	SO512 MBII6	SO512 MBII6	N100 GB5.4 K	NSM8 X	ABT_BRM4 318BG	N	N
AS5051AWX Mi	EMEA	Russia	LX.AV 30J.035	AS5051AW XMi MCERU9 UMAC 2*512/100/6L/ 5R_bg_0.3 C_AN	ATMK 36	N14.1 WXGA	SO512 MBII6	SO512 MBII6	N100 GB5.4 K	NSM8 X	ABT_BRM4 318BG	N	N
AS5051AWX Mi	EMEA	Eastern Europe	LX.AV 30J.036	AS5051AW XMi MCEPL7 UMAC 2*512/100/6L/ 5R_bg_0.3 C_AN	ATMK 36	N14.1 WXGA	SO512 MBII6	SO512 MBII6	N100 GB5.4 K	NSM8 X	ABT_BRM4 318BG	N	N

Model	RO	Country	Acer Part no	Description	CPU	LCD	DIMM 1	DIMM 2	HDD 1 (GB)	ODD	Wireless LAN	Bluetooth	VOIP Phone
AS5051AWX Mi	EMEA	Slovenia/Croatia	LX.AV 30J.037	AS5051AW XMi MCES11 UMAC 2*512/100/6L/ 5R_bg_0.3 C_AN	ATMK 36	N14.1 WXGA	SO512 MBII6	SO512 MBII6	N100 GB5.4 K	NSM8 X	ABT_BRM4 318BG	N	N
AS5051AWX Mi	EMEA	Portugal	LX.AV 30J.038	AS5051AW XMi MCEPT6 UMAC 2*512/100/6L/ 5R_bg_0.3 C_AN	ATMK 36	N14.1 WXGA	SO512 MBII6	SO512 MBII6	N100 GB5.4 K	NSM8 X	ABT_BRM4 318BG	N	N
AS5051AWX Mi	EMEA	Sweden/Finland	LX.AV 30J.029	AS5051AW XMi MCESV5 UMAC 2*512/100/6L/ 5R_bg_0.3 C_AN	ATMK 36	N14.1 WXGA	SO512 MBII6	SO512 MBII6	N100 GB5.4 K	NSM8 X	ABT_BRM4 318BG	N	N
AS5051AWX Mi	EMEA	Turkey	LX.AV 30J.041	AS5051AW XMi MCETR5 UMAC 2*512/100/6L/ 5R_bg_0.3 C_AN	ATMK 36	N14.1 WXGA	SO512 MBII6	SO512 MBII6	N100 GB5.4 K	NSM8 X	ABT_BRM4 318BG	N	N
AS5051AWX Mi	EMEA	Switzerland	LX.AV 30J.045	AS5051AW XMi MCESW8 UMAC 2*512/100/6L/ 5R_bg_0.3 C_AN	ATMK 36	N14.1 WXGA	SO512 MBII6	SO512 MBII6	N100 GB5.4 K	NSM8 X	ABT_BRM4 318BG	N	N
AS5051AWX Mi	EMEA	UK	LX.AV 30J.046	AS5051AW XMi MCEUK5 UMAC 2*512/100/6L/ 5R_bg_0.3 C_AN	ATMK 36	N14.1 WXGA	SO512 MBII6	SO512 MBII6	N100 GB5.4 K	NSM8 X	ABT_BRM4 318BG	N	N
AS5051AWX Mi	EMEA	UK	LX.AV 30J.047	AS5051AW XMi MCEWUK1 1W UMAC 2*512/100/6L/ 5R_bg_0.3 C_AN	ATMK 36	N14.1 WXGA	SO512 MBII6	SO512 MBII6	N100 GB5.4 K	NSM8 X	ABT_BRM4 318BG	N	N
AS5051AWX Mi	EMEA	Italy	LX.AV 30J.042	AS5051AW XMi MCEWIT11 W UMAC 2*512/100/6L/ 5R_bg_0.3 C_AN	ATMK 36	N14.1 WXGA	SO512 MBII6	SO512 MBII6	N100 GB5.4 K	NSM8 X	ABT_BRM4 318BG	N	N
AS5051AWX Mi	EMEA	Germany	LX.AV 30J.031	AS5051AW XMi MCEWDE1 1W UMAC 2*512/100/6L/ 5R_bg_0.3 C_AN	ATMK 36	N14.1 WXGA	SO512 MBII6	SO512 MBII6	N100 GB5.4 K	NSM8 X	ABT_BRM4 318BG	N	N



Model	RO	Country	Acer Part no	Description	CPU	LCD	DIMM 1	DIMM 2	HDD 1 (GB)	ODD	Wireless LAN	Bluetooth	VOIP Phone
AS5051AWX Mi	EMEA	France	LX.AV 30J.026	AS5051AW XMi MCEWFR1 1W UMAC 2*512/100/6L/ 5R_bg_0.3 C_AN	ATMK 36	N14.1 WXGA	SO512 MBII6	SO512 MBII6	N100 GB5.4 K	NSM8 X	ABT_BRM4 318BG	N	N
AS5051AWX Mi	EMEA	Belgium	LX.AV 305.019	AS5051AW XMi XPHBE1 UMAC 2*512/100/6L/ 5R_bg_0.3 C_AN	ATMK 36	N14.1 WXGA	SO512 MBII6	SO512 MBII6	N100 GB5.4 K	NSM8 X	ABT_BRM4 318BG	N	N
AS5051AWX Mi	EMEA	Middle East	LX.AV 305.038	AS5051AW XMi XPHAR1 UMAC 2*512/100/6L/ 5R_bg_0.3 C_AN	ATMK 36	N14.1 WXGA	SO512 MBII6	SO512 MBII6	N100 GB5.4 K	NSM8 X	ABT_BRM4 318BG	N	N
AS5051AWX Mi	EMEA	Eastern Europe	LX.AV 305.027	AS5051AW XMi XPHCS2 UMAC 2*512/100/6L/ 5R_bg_0.3 C_AN	ATMK 36	N14.1 WXGA	SO512 MBII6	SO512 MBII6	N100 GB5.4 K	NSM8 X	ABT_BRM4 318BG	N	N
AS5051AWX Mi	EMEA	Germany	LX.AV 305.023	AS5051AW XMi XPHDE7 UMAC 2*512/100/6L/ 5R_bg_0.3 C_AN	ATMK 36	N14.1 WXGA	SO512 MBII6	SO512 MBII6	N100 GB5.4 K	NSM8 X	ABT_BRM4 318BG	N	N
AS5051AWX Mi	EMEA	Greece	LX.AV 305.033	AS5051AW XMi XPHEL1 UMAC 2*512/100/6L/ 5R_bg_0.3 C_AN	ATMK 36	N14.1 WXGA	SO512 MBII6	SO512 MBII6	N100 GB5.4 K	NSM8 X	ABT_BRM4 318BG	N	N
AS5051AWX Mi	EMEA	Israel	LX.AV 305.034	AS5051AW XMi XPHIS1 UMAC 2*512/100/6L/ 5R_bg_0.3 C_AN	ATMK 36	N14.1 WXGA	SO512 MBII6	SO512 MBII6	N100 GB5.4 K	NSM8 X	ABT_BRM4 318BG	N	N
AS5051AWX Mi	EMEA	Italy	LX.AV 305.035	AS5051AW XMi XPHIT1 UMAC 2*512/100/6L/ 5R_bg_0.3 C_AN	ATMK 36	N14.1 WXGA	SO512 MBII6	SO512 MBII6	N100 GB5.4 K	NSM8 X	ABT_BRM4 318BG	N	N
AS5051AWX Mi	EMEA	Denmark	LX.AV 305.018	AS5051AW XMi XPHDK1 UMAC 2*512/100/6L/ 5R_bg_0.3 C_AN	ATMK 36	N14.1 WXGA	SO512 MBII6	SO512 MBII6	N100 GB5.4 K	NSM8 X	ABT_BRM4 318BG	N	N

Model	RO	Country	Acer Part no	Description	CPU	LCD	DIMM 1	DIMM 2	HDD 1 (GB)	ODD	Wireless LAN	Bluetooth	VOIP Phone
AS5051AWX Mi	EMEA	Holland	LX.AV 305.020	AS5051AW XMi XPHNL1 UMAC 2*512/100/6L/ 5R_bg_0.3 C_AN	ATMK 36	N14.1 WXGA	SO512 MBII6	SO512 MBII6	N100 GB5.4 K	NSM8 X	ABT_BRM4 318BG	N	N
AS5051AWX Mi	EMEA	France	LX.AV 305.021	AS5051AW XMi XPHFRA UMAC 2*512/100/6L/ 5R_bg_0.3 C_AN	ATMK 36	N14.1 WXGA	SO512 MBII6	SO512 MBII6	N100 GB5.4 K	NSM8 X	ABT_BRM4 318BG	N	N
AS5051AWX Mi	EMEA	Eastern Europe	LX.AV 305.028	AS5051AW XMi XPHHU6 UMAC 2*512/100/6L/ 5R_bg_0.3 C_AN	ATMK 36	N14.1 WXGA	SO512 MBII6	SO512 MBII6	N100 GB5.4 K	NSM8 X	ABT_BRM4 318BG	N	N
AS5051AWX Mi	EMEA	Spain	LX.AV 305.031	AS5051AW XMi XPHESA UMAC 2*512/100/6L/ 5R_bg_0.3 C_AN	ATMK 36	N14.1 WXGA	SO512 MBII6	SO512 MBII6	N100 GB5.4 K	NSM8 X	ABT_BRM4 318BG	N	N
AS5051AWX Mi	EMEA	Slovenia/Croatia	LX.AV 305.030	AS5051AW XMi XPHSLO2 UMAC 2*512/100/6L/ 5R_bg_0.3 C_AN	ATMK 36	N14.1 WXGA	SO512 MBII6	SO512 MBII6	N100 GB5.4 K	NSM8 X	ABT_BRM4 318BG	N	N
AS5051AWX Mi	EMEA	Eastern Europe	LX.AV 305.029	AS5051AW XMi XPHPL6 UMAC 2*512/100/6L/ 5R_bg_0.3 C_AN	ATMK 36	N14.1 WXGA	SO512 MBII6	SO512 MBII6	N100 GB5.4 K	NSM8 X	ABT_BRM4 318BG	N	N
AS5051AWX Mi	EMEA	Portugal	LX.AV 305.032	AS5051AW XMi XPHPT1 UMAC 2*512/100/6L/ 5R_bg_0.3 C_AN	ATMK 36	N14.1 WXGA	SO512 MBII6	SO512 MBII6	N100 GB5.4 K	NSM8 X	ABT_BRM4 318BG	N	N
AS5051AWX Mi	EMEA	Switzerland	LX.AV 305.039	AS5051AW XMi XPHSW5 UMAC 2*512/100/6L/ 5R_bg_0.3 C_AN	ATMK 36	N14.1 WXGA	SO512 MBII6	SO512 MBII6	N100 GB5.4 K	NSM8 X	ABT_BRM4 318BG	N	N
AS5051AWX Mi	EMEA	Turkey	LX.AV 305.036	AS5051AW XMi XPHTR1 UMAC 2*512/100/6L/ 5R_bg_0.3 C_AN	ATMK 36	N14.1 WXGA	SO512 MBII6	SO512 MBII6	N100 GB5.4 K	NSM8 X	ABT_BRM4 318BG	N	N

Model	RO	Country	Acer Part no	Description	CPU	LCD	DIMM 1	DIMM 2	HDD 1 (GB)	ODD	Wireless LAN	Bluetooth	VOIP Phone
AS5051AWX Mi	EMEA	South Africa	LX.AV 305.017	AS5051AW XMi XPHSA1 UMAC 2*512/100/6L/ 5R_bg_0.3 C_AN	ATMK 36	N14.1 WXGA	SO512 MBII6	SO512 MBII6	N100 GB5.4 K	NSM8 X	ABT_BRM4 318BG	N	N
AS5051AWX Mi	EMEA	Norway	LX.AV 305.024	AS5051AW XMi XPHNO1 UMAC 2*512/100/6L/ 5R_bg_0.3 C_AN	ATMK 36	N14.1 WXGA	SO512 MBII6	SO512 MBII6	N100 GB5.4 K	NSM8 X	ABT_BRM4 318BG	N	N
AS5051AWX Mi	EMEA	Russia	LX.AV 305.025	AS5051AW XMi XPHRU2 UMAC 2*512/100/6L/ 5R_bg_0.3 C_AN	ATMK 36	N14.1 WXGA	SO512 MBII6	SO512 MBII6	N100 GB5.4 K	NSM8 X	ABT_BRM4 318BG	N	N
AS5051AWX Mi	EMEA	Sweden/ Finland	LX.AV 305.026	AS5051AW XMi XPHSV1 UMAC 2*512/100/6L/ 5R_bg_0.3 C_AN	ATMK 36	N14.1 WXGA	SO512 MBII6	SO512 MBII6	N100 GB5.4 K	NSM8 X	ABT_BRM4 318BG	N	N
AS5051AWX Mi	EMEA	France	LX.AV 305.022	AS5051AW XMi XPHWFRB 1W UMAC 2*512/100/6L/ 5R_bg_0.3 C_AN	ATMK 36	N14.1 WXGA	SO512 MBII6	SO512 MBII6	N100 GB5.4 K	NSM8 X	ABT_BRM4 318BG	N	N
AS5051AWX Mi	EMEA	Italy	LX.AV 305.037	AS5051AW XMi XPHWIT21 W UMAC 2*512/100/6L/ 5R_bg_0.3 C_AN	ATMK 36	N14.1 WXGA	SO512 MBII6	SO512 MBII6	N100 GB5.4 K	NSM8 X	ABT_BRM4 318BG	N	N
AS5051AWX Mi	EMEA	UK	LX.AV 305.040	AS5051AW XMi XPHUK1 UMAC 2*512/100/6L/ 5R_bg_0.3 C_AN	ATMK 36	N14.1 WXGA	SO512 MBII6	SO512 MBII6	N100 GB5.4 K	NSM8 X	ABT_BRM4 318BG	N	N
AS5051AWX Mi	EMEA	UK	LX.AV 305.041	AS5051AW XMi XPHWUK2 1W UMAC 2*512/100/6L/ 5R_bg_0.3 C_AN	ATMK 36	N14.1 WXGA	SO512 MBII6	SO512 MBII6	N100 GB5.4 K	NSM8 X	ABT_BRM4 318BG	N	N
AS5052WXM i	PA	USA/ Canada - Canadian French	LX.AV 30J.020	AS5052WXM i MCECF UMAC 2*512/120/6L/5R/ CB_bg_0.3 C_AN	ATTL5 0	N14.1 WXGA G	SO512 MBII5	SO512 MBII5	N120 GB5.4 K	NSM8 X	ABT_ATH54 13BG	N	N

Model	RO	Country	Acer Part no	Description	CPU	LCD	DIMM 1	DIMM 2	HDD 1 (GB)	ODD	Wireless LAN	Bluetooth	VOIP Phone
AS5052WXM i	PA	USA/Canada - Canadian French	LX.AV 30J.021	AS5052WXM i MCEUS UMAC 2*512/120/6L/5R/CB_bg_0.3 C_AN	ATTL50	N14.1 WXGAG	SO512 MBII5	SO512 MBII5	N120 GB5.4 K	NSM8 X	ABT_ATH54 13BG	N	N
AS5052WXM i	PA	ACLA-Spanish	LX.AV 30J.022	AS5052WXM i MCEES1 UMAC 2*512/120/6L/5R/CB_bg_0.3 C_AN	ATTL50	N14.1 WXGAG	SO512 MBII5	SO512 MBII5	N120 GB5.4 K	NSM8 X	ABT_ATH54 13BG	N	N
AS5051AWX Mi	PA	ACLA-Spanish	LX.AV 30J.048	AS5051AWX Mi MCEES1 UMAC 2*512/120/6L/5R/CB_bg_0.3 C_AN	ATMK36	N14.1 WXGAG	SO512 MBII5	SO512 MBII5	N120 GB5.4 K	NSM8 X	ABT_BRM4 318BG	N	N
AS5051ANW XCi	AAP	Australia/New Zealand	LX.AV 30C.017	AS5051ANW XCi LINPUSAU 1 UMAC 1*512/80/6L/5R/CB_bg_0.3 C_AN	ATMK36	N14.1 WXGAG	SO512 MBII5	N	N80G B5.4K	NCB2 4X	ABT_BRM4 318BG	N	N
AS5051AWX Ci	AAP	Malaysia	LX.AV 305.042	AS5051AWX Ci XPHMA2 UMAC 1*512/80/6L/5R/CB_bg_0.3 C_AN	ATMK36	N14.1 WXGAG	SO512 MBII5	N	N80G B5.4K	NCB2 4X	ABT_BRM4 318BG	N	N
AS5051ANW XCi	AAP	Malaysia	LX.AV 30C.018	AS5051ANW XCi LINPUSMA 2 UMAC 1*512/80/6L/5R/CB_bg_0.3 C_AN	ATMK36	N14.1 WXGAG	SO512 MBII5	N	N80G B5.4K	NCB2 4X	ABT_BRM4 318BG	N	N
AS5051AWX Mi	EMEA	Sweden/Finland	LX.AV 30J.049	AS5051AWX Mi MCESV5 UMAC 1*512/100/BT/6L/5R/CB_bg_VP_0.3C_AN	ATMK36	N14.1 WXGAG	SO512 MBII6	N	N100 GB5.4 K	NSM8 X	ABT_BRM4 318BG	FOX_BRM_2.0	BT VoIP PCMC IA
AS5051AWX Mi	EMEA	Slovenia/Croatia	LX.AV 30J.050	AS5051AWX Mi MCES1 UMAC 1*512/100/BT/6L/5R/CB_bg_VP_0.3C_AN	ATMK36	N14.1 WXGAG	SO512 MBII6	N	N100 GB5.4 K	NSM8 X	ABT_BRM4 318BG	FOX_BRM_2.0	BT VoIP PCMC IA
AS5051AWX Mi	EMEA	Holland	LX.AV 30J.051	AS5051AWX Mi MCENL6 UMAC 1*512/100/BT/6L/5R/CB_bg_VP_0.3C_AN	ATMK36	N14.1 WXGAG	SO512 MBII6	N	N100 GB5.4 K	NSM8 X	ABT_BRM4 318BG	FOX_BRM_2.0	BT VoIP PCMC IA

Model	RO	Country	Acer Part no	Description	CPU	LCD	DIMM 1	DIMM 2	HDD 1 (GB)	ODD	Wireless LAN	Bluetooth	VOIP Phone
AS5051AWX Mi	EMEA	Russia	LX.AV 30J.05 2	AS5051AW XMi MCERU9 UMAC 1*512/100/ BT/6L/5R/ CB_bg_VP_0.3C_AN	ATMK 36	N14.1 WXGA G	SO512 MBII6	N	N100 GB5.4 K	NSM8 X	ABT_ BRM4 318BG	FOX_ BRM_ 2.0	BT VoIP PCMC IA
AS5051AWX Mi	EMEA	Holland	LX.AV 30J.05 4	AS5051AW XMi MCENL6 UMAC 1*512/100/ BT/6L/ 5R_bg_VP_0.3C_AN	ATMK 36	N14.1 WXGA	SO512 MBII6	N	N100 GB5.4 K	NSM8 X	ABT_ BRM4 318BG	FOX_ BRM_ 2.0	BT VoIP PCMC IA
AS5051AWX Mi	EMEA	Russia	LX.AV 305.04 3	AS5051AW XMi XPHRU2 UMAC 1*512/100/ 6L/ 5R_bg_0.3 C_AN	ATMK 36	N14.1 WXGA	SO512 MBII6	N	N100 GB5.4 K	NSM8 X	ABT_ BRM4 318BG	N	N
AS5051AWX Mi	EMEA	Sweden/ Finland	LX.AV 30J.05 5	AS5051AW XMi MCEV5 UMAC 1*512/100/ BT/6L/ 5R_bg_VP_0.3C_AN	ATMK 36	N14.1 WXGA	SO512 MBII6	N	N100 GB5.4 K	NSM8 X	ABT_ BRM4 318BG	FOX_ BRM_ 2.0	BT VoIP PCMC IA
AS5051AWX Mi	EMEA	Slovenia/ Croatia	LX.AV 30J.05 3	AS5051AW XMi MCES11 UMAC 1*512/100/ BT/6L/ 5R_bg_VP_0.3C_AN	ATMK 36	N14.1 WXGA	SO512 MBII6	N	N100 GB5.4 K	NSM8 X	ABT_ BRM4 318BG	FOX_ BRM_ 2.0	BT VoIP PCMC IA
AS5052NWX Mi	AAP	Thailand	LX.AV 30C.0 19	AS5052N WXM i LINPUSH 2 UMAC 1*512/120/ BT/6L/5R/ CB_bg_0.3 C_AN	ATTL5 0	N14.1 WXGA G	SO512 MBII5	N	N120 GB5.4 K	NSM8 X	ABT_ BRM4 318BG	FOX_ BRM_ 2.0	N
AS5053WXM i	AAP	Thailand	LX.AV 30J.05 6	AS5053WXM i MCETH1 UMAC 1*1G/120/ BT/6L/5R/ CB_bg_0.3 C_AN	ATTL5 2	N14.1 WXGA G	SO1G BII6	N	N120 GB5.4 K	NSM8 X	ABT_ BRM4 318BG	FOX_ BRM_ 2.0	N
AS5051ANW XMi	EMEA	Middle East	LX.AV 30C.0 22	AS5051AN WXM i LINPUSAR 9 UMAC 1*512/60/ BT/6L/ 5R_bg_0.3 C_AN	ATMK 36	N14.1 WXGA	SO512 MBII5	N	N60G B5.4K	NSM8 X	ABT_ BRM4 318BG	FOX_ BRM_ 2.0	N
AS5051ANW XMi	EMEA	Middle East	LX.AV 30C.0 24	AS5051AN WXM i LINPUSAR 9 UMAC 1*512/60/ BT/6L/5R/ CB_bg_0.3 C_AN	ATMK 36	N14.1 WXGA G	SO512 MBII5	N	N60G B5.4K	NSM8 X	ABT_ BRM4 318BG	FOX_ BRM_ 2.0	N

Model	RO	Country	Acer Part no	Description	CPU	LCD	DIMM 1	DIMM 2	HDD 1 (GB)	ODD	Wireless LAN	Bluetooth	VOIP Phone
AS5051ANW XMi	EMEA	Middle East	LX.AV 30C.0 20	AS5051AN WXMi LINPUSAR 7 UMAC 1*512/60/ BT/6L/ 5R_bg_0.3 C_AN	ATMK 36	N14.1 WXGA	SO512 MBII5	N	N60G B5.4K	NSM8 X	ABT_ BRM4 318BG	FOX_ BRM_ 2.0	N
AS5051ANW XMi	EMEA	France	LX.AV 30C.0 21	AS5051AN WXMi LINPUSFR A UMAC 1*512/60/ 6L/ 5R_bg_0.3 C_AN	ATMK 36	N14.1 WXGA	SO512 MBII5	N	N60G B5.4K	NSM8 X	ABT_ BRM4 318BG	N	N
AS5051ANW XMi	EMEA	Russia	LX.AV 30C.0 23	AS5051AN WXMi LINPUSRU 5 UMAC 1*512/60/ 6L/ 5R_bg_0.3 C_AN	ATMK 36	N14.1 WXGA	SO512 MBII5	N	N60G B5.4K	NSM8 X	ABT_ BRM4 318BG	N	N
AS5051AWX Mi	EMEA	Middle East	LX.AV 305.04 4	AS5051AW XMi XPHAR8 UMAC 1*512/60/ BT/6L/5R/ CB_bg_0.3 C_AN	ATMK 36	N14.1 WXGA G	SO512 MBII5	N	N60G B5.4K	NSM8 X	ABT_ BRM4 318BG	FOX_ BRM_ 2.0	N
AS5051AWX Mi	EMEA	Eastern Europe	LX.AV 30J.05 7	AS5051AW XMi MCEPL7 UMAC 1*512/100/ BT/6L/ 5R_bg_VP _0.3C_AN	ATMK 36	N14.1 WXGA	SO512 MBII6	N	N100 GB5.4 K	NSM8 X	ABT_ BRM4 318BG	FOX_ BRM_ 2.0	BT VoIP PCMC IA
AS5051AWX Mi	EMEA	Russia	LX.AV 305.04 5	AS5051AW XMi XPHRU1 UMAC 1*512/100/ BT/6L/ 5R_bg_VP _0.3C_AN	ATMK 36	N14.1 WXGA	SO512 MBII6	N	N100 GB5.4 K	NSM8 X	ABT_ BRM4 318BG	FOX_ BRM_ 2.0	BT VoIP PCMC IA
AS5052WXM i	TWN	GCTWN	LX.AV 30J.05 8	AS5052WX Mi MCETC9 UMAC 1*512/120/ BT/6L/5R/ CB_bg_0.3 C_AN	ATTL5 0	N14.1 WXGA G	SO512 MBII5	N	N120 GB5.4 K	NSM8 X	ABT_ BRM4 318BG	FOX_ BRM_ 2.0	N
AS5052WXM i	TWN	GCTWN	LX.AV 305.04 6	AS5052WX Mi XPHTC1 UMAC 1*512/120/ BT/6L/5R/ CB_bg_0.3 C_AN	ATTL5 0	N14.1 WXGA G	SO512 MBII5	N	N120 GB5.4 K	NSM8 X	ABT_ ATH54 13BG	FOX_ BRM_ 2.0	N
AS5051AWX Mi	EMEA	Switzerland	LX.AV 30J.05 9	AS5051AW XMi MCESW8 UMAC 2*512/120/ BT/6L/5R/ CB_bg_0.3 C_AN	ATMK 36	N14.1 WXGA G	SO512 MBII5	SO512 MBII5	N120 GB5.4 K	NSM8 X	ABT_ BRM4 318BG	FOX_ BRM_ 2.0	N

Model	RO	Country	Acer Part no	Description	CPU	LCD	DIMM 1	DIMM 2	HDD 1 (GB)	ODD	Wireless LAN	Bluetooth	VOIP Phone
AS5051AWX Mi	EMEA	Switzerland	LX.AV 30J.060	AS5051AW XMi MCESW8 UMAC 2*512/120/6L/5R/CB_bg_0.3 C_AN	ATMK 36	N14.1 WXGA G	SO512 MBII5	SO512 MBII5	N120 GB5.4 K	NSM8 X	ABT_BRM4 318BG	N	N
AS5051AWX Mi	EMEA	Portugal	LX.AV 30J.061	AS5051AW XMi MCEPT6 UMAC 2*512/120/6L/5R_bg_0.3 C_AN	ATMK 36	N14.1 WXGA	SO512 MBII5	SO512 MBII5	N120 GB5.4 K	NSM8 X	ABT_BRM4 318BG	N	N
AS5051AWX Mi	EMEA	Spain	LX.AV 30J.062	AS5051AW XMi MCEESJ UMAC 2*512/120/6L/5R_bg_0.3 C_AN	ATMK 36	N14.1 WXGA	SO512 MBII5	SO512 MBII5	N120 GB5.4 K	NSM8 X	ABT_BRM4 318BG	N	N
AS5051AWX Mi	EMEA	Germany	LX.AV 30J.064	AS5051AW XMi MCEDEA UMAC 2*512/120/6L/5R_bg_0.3 C_AN	ATMK 36	N14.1 WXGA	SO512 MBII5	SO512 MBII5	N120 GB5.4 K	NSM8 X	ABT_BRM4 318BG	N	N
AS5051AWX Mi	EMEA	Germany	LX.AV 30J.065	AS5051AW XMi MCEDEB UMAC 2*512/120/6L/5R_bg_0.3 C_AN	ATMK 36	N14.1 WXGA	SO512 MBII5	SO512 MBII5	N120 GB5.4 K	NSM8 X	ABT_BRM4 318BG	N	N
AS5051AWX Mi	EMEA	Middle East	LX.AV 30J.070	AS5051AW XMi MCEAR1 UMAC 2*512/120/6L/5R_bg_0.3 C_AN	ATMK 36	N14.1 WXGA	SO512 MBII5	SO512 MBII5	N120 GB5.4 K	NSM8 X	ABT_BRM4 318BG	N	N
AS5051AWX Mi	EMEA	Middle East	LX.AV 30J.084	AS5051AW XMi MCEAR2 UMAC 2*512/120/6L/5R_bg_0.3 C_AN	ATMK 36	N14.1 WXGA	SO512 MBII5	SO512 MBII5	N120 GB5.4 K	NSM8 X	ABT_BRM4 318BG	N	N
AS5051AWX Mi	EMEA	Belgium	LX.AV 30J.066	AS5051AW XMi MCEBE6 UMAC 2*512/120/6L/5R_bg_0.3 C_AN	ATMK 36	N14.1 WXGA	SO512 MBII5	SO512 MBII5	N120 GB5.4 K	NSM8 X	ABT_BRM4 318BG	N	N
AS5051AWX Mi	EMEA	Eastern Europe	LX.AV 30J.079	AS5051AW XMi MCECS5 UMAC 2*512/120/6L/5R_bg_0.3 C_AN	ATMK 36	N14.1 WXGA	SO512 MBII5	SO512 MBII5	N120 GB5.4 K	NSM8 X	ABT_BRM4 318BG	N	N

Model	RO	Country	Acer Part no	Description	CPU	LCD	DIMM 1	DIMM 2	HDD 1 (GB)	ODD	Wireless LAN	Bluetooth	VOIP Phone
AS5051AWX Mi	EMEA	Holland	LX.AV 30J.069	AS5051AW XMi MCENL6 UMAC 2*512/120/6L/ 5R_bg_0.3 C_AN	ATMK 36	N14.1 WXGA	SO512 MBII5	SO512 MBII5	N120 GB5.4 K	NSM8 X	ABT_BRM4 318BG	N	N
AS5051AWX Mi	EMEA	Italy	LX.AV 30J.071	AS5051AW XMi MCEIT7 UMAC 2*512/120/6L/ 5R_bg_0.3 C_AN	ATMK 36	N14.1 WXGA	SO512 MBII5	SO512 MBII5	N120 GB5.4 K	NSM8 X	ABT_BRM4 318BG	N	N
AS5051AWX Mi	EMEA	Denmark	LX.AV 30J.074	AS5051AW XMi MCEDK6 UMAC 2*512/120/6L/ 5R_bg_0.3 C_AN	ATMK 36	N14.1 WXGA	SO512 MBII5	SO512 MBII5	N120 GB5.4 K	NSM8 X	ABT_BRM4 318BG	N	N
AS5051AWX Mi	EMEA	France	LX.AV 30J.063	AS5051AW XMi MCEFRF UMAC 2*512/120/6L/ 5R_bg_0.3 C_AN	ATMK 36	N14.1 WXGA	SO512 MBII5	SO512 MBII5	N120 GB5.4 K	NSM8 X	ABT_BRM4 318BG	N	N
AS5051AWX Mi	EMEA	Norway	LX.AV 30J.073	AS5051AW XMi MCENO5 UMAC 1*512/80/6L/ 5R_bg_0.3 C_AN	ATMK 36	N14.1 WXGA	SO512 MBII6	N	N80G B5.4K	NSM8 X	ABT_BRM4 318BG	N	N
AS5051AWX Mi	EMEA	Norway	LX.AV 30J.075	AS5051AW XMi MCENO5 UMAC 2*512/120/6L/ 5R_bg_0.3 C_AN	ATMK 36	N14.1 WXGA	SO512 MBII5	SO512 MBII5	N120 GB5.4 K	NSM8 X	ABT_BRM4 318BG	N	N
AS5051AWX Mi	EMEA	Russia	LX.AV 30J.080	AS5051AW XMi MCERU9 UMAC 2*512/120/6L/ 5R_bg_0.3 C_AN	ATMK 36	N14.1 WXGA	SO512 MBII5	SO512 MBII5	N120 GB5.4 K	NSM8 X	ABT_BRM4 318BG	N	N
AS5051AWX Mi	EMEA	Slovenia/Croatia	LX.AV 30J.085	AS5051AW XMi MCESI1 UMAC 2*512/120/6L/ 5R_bg_0.3 C_AN	ATMK 36	N14.1 WXGA	SO512 MBII5	SO512 MBII5	N120 GB5.4 K	NSM8 X	ABT_BRM4 318BG	N	N
AS5051AWX Mi	EMEA	Switzerland	LX.AV 30J.086	AS5051AW XMi MCESW8 UMAC 2*512/120/6L/ 5R_bg_0.3 C_AN	ATMK 36	N14.1 WXGA	SO512 MBII5	SO512 MBII5	N120 GB5.4 K	NSM8 X	ABT_BRM4 318BG	N	N



Model	RO	Country	Acer Part no	Description	CPU	LCD	DIMM 1	DIMM 2	HDD 1 (GB)	ODD	Wireless LAN	Bluetooth	VOIP Phone
AS5051AWX Mi	EMEA	Eastern Europe	LX.AV 30J.068	AS5051AW XMi MCEPL7 UMAC 2*512/120/6L/ 5R_bg_0.3 C_AN	ATMK 36	N14.1 WXGA	SO512 MBII5	SO512 MBII5	N120 GB5.4 K	NSM8 X	ABT_BRM4 318BG	N	N
AS5051AWX Mi	EMEA	Sweden/ Finland	LX.AV 30J.067	AS5051AW XMi MCESV5 UMAC 2*512/120/6L/ 5R_bg_0.3 C_AN	ATMK 36	N14.1 WXGA	SO512 MBII5	SO512 MBII5	N120 GB5.4 K	NSM8 X	ABT_BRM4 318BG	N	N
AS5051AWX Mi	EMEA	UK	LX.AV 30J.081	AS5051AW XMi MCEUUK1 1U UMAC 2*512/120/6L/ 5R_bg_0.3 C_AN	ATMK 36	N14.1 WXGA	SO512 MBII5	SO512 MBII5	N120 GB5.4 K	NSM8 X	ABT_BRM4 318BG	N	N
AS5051AWX Mi	EMEA	UK	LX.AV 30J.087	AS5051AW XMi MCEUK5 UMAC 2*512/120/6L/ 5R_bg_0.3 C_AN	ATMK 36	N14.1 WXGA	SO512 MBII5	SO512 MBII5	N120 GB5.4 K	NSM8 X	ABT_BRM4 318BG	N	N
AS5051AWX Mi	EMEA	Turkey	LX.AV 30J.072	AS5051AW XMi MCETR5 UMAC 2*512/120/6L/ 5R_bg_0.3 C_AN	ATMK 36	N14.1 WXGA	SO512 MBII5	SO512 MBII5	N120 GB5.4 K	NSM8 X	ABT_BRM4 318BG	N	N
AS5051AWX Mi	EMEA	Italy	LX.AV 30J.076	AS5051AW XMi MCEWIT11 W UMAC 2*512/120/6L/ 5R_bg_0.3 C_AN	ATMK 36	N14.1 WXGA	SO512 MBII5	SO512 MBII5	N120 GB5.4 K	NSM8 X	ABT_BRM4 318BG	N	N
AS5051AWX Mi	EMEA	UK	LX.AV 30J.088	AS5051AW XMi MCEUK6 UMAC 2*512/120/6L/ 5R_bg_0.3 C_AN	ATMK 36	N14.1 WXGA	SO512 MBII5	SO512 MBII5	N120 GB5.4 K	NSM8 X	ABT_BRM4 318BG	N	N
AS5051AWX Mi	EMEA	France	LX.AV 30J.077	AS5051AW XMi MCEWFR1 1W UMAC 2*512/120/6L/ 5R_bg_0.3 C_AN	ATMK 36	N14.1 WXGA	SO512 MBII5	SO512 MBII5	N120 GB5.4 K	NSM8 X	ABT_BRM4 318BG	N	N
AS5051AWX Mi	EMEA	Germany	LX.AV 30J.078	AS5051AW XMi MCEWDE1 1W UMAC 2*512/120/6L/ 5R_bg_0.3 C_AN	ATMK 36	N14.1 WXGA	SO512 MBII5	SO512 MBII5	N120 GB5.4 K	NSM8 X	ABT_BRM4 318BG	N	N

Model	RO	Country	Acer Part no	Description	CPU	LCD	DIMM 1	DIMM 2	HDD 1 (GB)	ODD	Wireless LAN	Bluetooth	VOIP Phone
AS5051AWX Mi	EMEA	Germany	LX.AV 305.057	AS5051AW XMi XPHDE7 UMAC 2*512/120/6L/ 5R_bg_0.3 C_AN	ATMK 36	N14.1 WXGA	SO512 MBII5	SO512 MBII5	N120 GB5.4 K	NSM8 X	ABT_BRM4 318BG	N	N
AS5051AWX Mi	EMEA	Middle East	LX.AV 305.061	AS5051AW XMi XPHAR1 UMAC 2*512/120/6L/ 5R_bg_0.3 C_AN	ATMK 36	N14.1 WXGA	SO512 MBII5	SO512 MBII5	N120 GB5.4 K	NSM8 X	ABT_BRM4 318BG	N	N
AS5051AWX Mi	EMEA	Denmark	LX.AV 305.047	AS5051AW XMi XPHDK1 UMAC 2*512/120/6L/ 5R_bg_0.3 C_AN	ATMK 36	N14.1 WXGA	SO512 MBII5	SO512 MBII5	N120 GB5.4 K	NSM8 X	ABT_BRM4 318BG	N	N
AS5051AWX Mi	EMEA	Belgium	LX.AV 305.056	AS5051AW XMi XPHBE1 UMAC 2*512/120/6L/ 5R_bg_0.3 C_AN	ATMK 36	N14.1 WXGA	SO512 MBII5	SO512 MBII5	N120 GB5.4 K	NSM8 X	ABT_BRM4 318BG	N	N
AS5051AWX Mi	EMEA	Eastern Europe	LX.AV 305.052	AS5051AW XMi XPHCS2 UMAC 2*512/120/6L/ 5R_bg_0.3 C_AN	ATMK 36	N14.1 WXGA	SO512 MBII5	SO512 MBII5	N120 GB5.4 K	NSM8 X	ABT_BRM4 318BG	N	N
AS5051AWX Mi	EMEA	UK	LX.AV 30J.083	AS5051AW XMi MCEWUK1 1W UMAC 2*512/120/6L/ 5R_bg_0.3 C_AN	ATMK 36	N14.1 WXGA	SO512 MBII5	SO512 MBII5	N120 GB5.4 K	NSM8 X	ABT_BRM4 318BG	N	N
AS5051AWX Mi	EMEA	UK	LX.AV 30J.082	AS5051AW XMi MCEWUK2 1W UMAC 2*512/120/6L/ 5R_bg_0.3 C_AN	ATMK 36	N14.1 WXGA	SO512 MBII5	SO512 MBII5	N120 GB5.4 K	NSM8 X	ABT_BRM4 318BG	N	N
AS5051AWX Mi	EMEA	Eastern Europe	LX.AV 305.051	AS5051AW XMi XPHHU6 UMAC 2*512/120/6L/ 5R_bg_0.3 C_AN	ATMK 36	N14.1 WXGA	SO512 MBII5	SO512 MBII5	N120 GB5.4 K	NSM8 X	ABT_BRM4 318BG	N	N
AS5051AWX Mi	EMEA	Spain	LX.AV 305.059	AS5051AW XMi XPHESA UMAC 2*512/120/6L/ 5R_bg_0.3 C_AN	ATMK 36	N14.1 WXGA	SO512 MBII5	SO512 MBII5	N120 GB5.4 K	NSM8 X	ABT_BRM4 318BG	N	N

Model	RO	Country	Acer Part no	Description	CPU	LCD	DIMM 1	DIMM 2	HDD 1 (GB)	ODD	Wireless LAN	Bluetooth	VOIP Phone
AS5051AWX Mi	EMEA	Greece	LX.AV 305.054	AS5051AW XMi XPHEL1 UMAC 2*512/120/6L/ 5R_bg_0.3 C_AN	ATMK 36	N14.1 WXGA	SO512 MBII5	SO512 MBII5	N120 GB5.4 K	NSM8 X	ABT_BRM4 318BG	N	N
AS5051AWX Mi	EMEA	Israel	LX.AV 305.069	AS5051AW XMi XPHIS1 UMAC 2*512/120/6L/ 5R_bg_0.3 C_AN	ATMK 36	N14.1 WXGA	SO512 MBII5	SO512 MBII5	N120 GB5.4 K	NSM8 X	ABT_BRM4 318BG	N	N
AS5051AWX Mi	EMEA	France	LX.AV 305.048	AS5051AW XMi XPHFRA UMAC 2*512/120/6L/ 5R_bg_0.3 C_AN	ATMK 36	N14.1 WXGA	SO512 MBII5	SO512 MBII5	N120 GB5.4 K	NSM8 X	ABT_BRM4 318BG	N	N
AS5051AWX Mi	EMEA	Italy	LX.AV 305.055	AS5051AW XMi XPHIT1 UMAC 2*512/120/6L/ 5R_bg_0.3 C_AN	ATMK 36	N14.1 WXGA	SO512 MBII5	SO512 MBII5	N120 GB5.4 K	NSM8 X	ABT_BRM4 318BG	N	N
AS5051AWX Mi	EMEA	Eastern Europe	LX.AV 305.053	AS5051AW XMi XPHPL6 UMAC 2*512/120/6L/ 5R_bg_0.3 C_AN	ATMK 36	N14.1 WXGA	SO512 MBII5	SO512 MBII5	N120 GB5.4 K	NSM8 X	ABT_BRM4 318BG	N	N
AS5051AWX Mi	EMEA	Holland	LX.AV 305.067	AS5051AW XMi XPHNL1 UMAC 2*512/120/6L/ 5R_bg_0.3 C_AN	ATMK 36	N14.1 WXGA	SO512 MBII5	SO512 MBII5	N120 GB5.4 K	NSM8 X	ABT_BRM4 318BG	N	N
AS5051AWX Mi	AAP	Malaysia	LX.AV 305.066	AS5051AW XMi XPHMA2 UMAC 1*512/80/6L/5R/ CB_bg_0.3 C_AN	ATMK 36	N14.1 WXGA G	SO512 MBII5	N	N80G B5.4K	NSM8 X	ABT_ATH54 13BG	N	N
AS5051AWX Mi	EMEA	Norway	LX.AV 305.058	AS5051AW XMi XPHNO1 UMAC 2*512/120/6L/ 5R_bg_0.3 C_AN	ATMK 36	N14.1 WXGA	SO512 MBII5	SO512 MBII5	N120 GB5.4 K	NSM8 X	ABT_BRM4 318BG	N	N
AS5051AWX Mi	EMEA	South Africa	LX.AV 305.062	AS5051AW XMi XPHSA1 UMAC 2*512/120/6L/ 5R_bg_0.3 C_AN	ATMK 36	N14.1 WXGA	SO512 MBII5	SO512 MBII5	N120 GB5.4 K	NSM8 X	ABT_BRM4 318BG	N	N

Model	RO	Country	Acer Part no	Description	CPU	LCD	DIMM 1	DIMM 2	HDD 1 (GB)	ODD	Wireless LAN	Bluetooth	VOIP Phone
AS5051AWX Mi	EMEA	Russia	LX.AV 305.049	AS5051AW XMi XPHRU2 UMAC 2*512/120/6L/ 5R_bg_0.3 C_AN	ATMK 36	N14.1 WXGA	SO512 MBII5	SO512 MBII5	N120 GB5.4 K	NSM8 X	ABT_BRM4 318BG	N	N
AS5051AWX Mi	EMEA	Sweden/ Finland	LX.AV 305.050	AS5051AW XMi XPHSV1 UMAC 2*512/120/6L/ 5R_bg_0.3 C_AN	ATMK 36	N14.1 WXGA	SO512 MBII5	SO512 MBII5	N120 GB5.4 K	NSM8 X	ABT_BRM4 318BG	N	N
AS5051AWX Mi	EMEA	Slovenia/ Croatia	LX.AV 305.063	AS5051AW XMi XPHSLO2 UMAC 2*512/120/6L/ 5R_bg_0.3 C_AN	ATMK 36	N14.1 WXGA	SO512 MBII5	SO512 MBII5	N120 GB5.4 K	NSM8 X	ABT_BRM4 318BG	N	N
AS5051AWX Mi	EMEA	Portugal	LX.AV 305.068	AS5051AW XMi XPHPT1 UMAC 2*512/120/6L/ 5R_bg_0.3 C_AN	ATMK 36	N14.1 WXGA	SO512 MBII5	SO512 MBII5	N120 GB5.4 K	NSM8 X	ABT_BRM4 318BG	N	N
AS5051AWX Mi	EMEA	Switzerland	LX.AV 305.064	AS5051AW XMi XPHSW5 UMAC 2*512/120/6L/ 5R_bg_0.3 C_AN	ATMK 36	N14.1 WXGA	SO512 MBII5	SO512 MBII5	N120 GB5.4 K	NSM8 X	ABT_BRM4 318BG	N	N
AS5051AWX Mi	EMEA	UK	LX.AV 305.065	AS5051AW XMi XPHUK1 UMAC 2*512/120/6L/ 5R_bg_0.3 C_AN	ATMK 36	N14.1 WXGA	SO512 MBII5	SO512 MBII5	N120 GB5.4 K	NSM8 X	ABT_BRM4 318BG	N	N
AS5051AWX Mi	EMEA	Turkey	LX.AV 305.070	AS5051AW XMi XPHTR1 UMAC 2*512/120/6L/ 5R_bg_0.3 C_AN	ATMK 36	N14.1 WXGA	SO512 MBII5	SO512 MBII5	N120 GB5.4 K	NSM8 X	ABT_BRM4 318BG	N	N
AS5051ANW XMi	EMEA	Turkey	LX.AV 30C.025	AS5051AN WXMi LINPUSTR 1 UMAC 1*512/60/6L/5R/ CB_bg_0.3 C_AN	ATMK 36	N14.1 WXGA G	SO512 MBII5	N	N60G B5.4K	NSM8 X	ABT_BRM4 318BG	N	N
AS5051AWX Mi	EMEA	Turkey	LX.AV 305.071	AS5051AW XMi XPHTR1 UMAC 1*512/60/6L/5R/ CB_bg_0.3 C_AN	ATMK 36	N14.1 WXGA G	SO512 MBII5	N	N60G B5.4K	NSM8 X	ABT_BRM4 318BG	N	N

Model	RO	Country	Acer Part no	Description	CPU	LCD	DIMM 1	DIMM 2	HDD 1 (GB)	ODD	Wireless LAN	Bluetooth	VOIP Phone
AS5052NWXMi	AAP	India	LX.AV30C.026	AS5052N WXM LINPUSIL1 UMAC 1*512/80/ BT/6L/5R/ CB_bg_0.3 C_AN	ATT50	N14.1 WXGA G	SO512 MBII5	N	N80G B5.4K	NSM8 X	ABT_ ATH54 13BG	FOX_ BRM_ 2.0	N



# Test Compatible Components

---

This computer's compatibility is tested and verified by Acer's internal testing department. All of its system functions are tested under Windows® XP Home, Windows® XP Pro environment.

Refer to the following lists for components, adapter cards, and peripherals which have passed these tests. Regarding configuration, combination and test procedures, please refer to the Aspire 4930 series Compatibility Test Report released by the Acer Mobile System Testing Department.

# Microsoft® Windows® Vista Environment Test

Item	Specification
<b>CRT Port Test</b>	
CRT Monitor	Acer 211c 21", ViewSonic G220F, ViewSonic PF790 19"
LCD Monitor	Acer FP751 17" TFT LCD, Acer AL1521, Acer AL1721, ViewSonic VD201b, Westinghouse W37G, HP LP2065, HP S9500
Projector	Dell 3300MP
<b>USB Port Test</b>	
USB Keyboard/Mouse	Microsoft Natural Keyboard Pro Dell USB Keyboard Logicool USB Mouse (OWCM-USB) Logitech USB Wheel Mouse Logitech First Wheel Mouse Dell by Logitech Dell Internet Navigator Keyboard Dell Smart Card Keyboard HP USB Optical Austin Mouse Belkin Miniglow Optical USB Mouse HP USB Optical Mouse (RB129AA)
USB Speaker/Joystick	Aiwa Multimedia Digital Speaker (SC-UC78) Panasonic USB Speaker EAB-MPC57USB
USB Storage Drive	Iomega USB Zip 250MB Transcend 80G HDD Plextor DVD+R/RW LG DVD+R/RW Sony DVD+R/RW
USB Camera	Intel Easy PC Camera (A20953-001) Orange Micro USB 2.0 Web Cam
USB HUB and Others	A TEN UH-204 IOGEAR 4-Port Hub Corega CG-WLUSBST11
USB Printer/Scanner	HP 450WBT Deskjet Printer
USB Flash Drive	Sony Memory Key 128MB Sony Micro Vault Pro USD-5G IBM 128MB Memory Key IBM 512MB Memory Key Apacer Handy Drive Apacer The USB Flash Drive 256MB
USB ODD	Logitec CDRW+DVDRROM combo LG DVD+R/RW Sony DVD+R/RW
1394 Camera	Sony DV-TRV10
Access Point 802.11a	Intel Pro/Wireless 5000 NetGear HE 102
Access Point 802.11g	D-Link Building Networks People WiFi Certified a/b/g Wireless 108AG



Item	Specification
Access Point 802.11n	Belkin N1MIMO Wireless Router High Performance wireless 802.11n
Bluetooth Device	Sony Ericsson Wireless Headset Sony Ericsson T610 X Bridge Bluetooth Access Point BT300
<b>PCMCIA Test</b>	
LAN/Modem Card	TDK CardBus Ethernet 10/100 32-Bit CBE-10/100BTX
Storage Card	Hitachi Microdrive 4G
1394 Card	Buffalo 1394 Interface Cardbus (IFC-ILCB/DV)
USB2.0 Card	IBM EtherJet CardBus Adapter 10/100
Wireless Lan Card (Not recommended for wireless ready model)	Cisco Wireless LAN Card 802.11a NETGEAR Wireless LAN card 802.11a
ISDN Card	Toshiba Type B for Bluetooth 128K ISDN Card
GPRS Card	Vodafone QL1ACC-21581 3G/GPRS card Sony Ericsson GC83 GPRS card Sony Ericsson GC89 GPRS card
<b>ExpressCard Test</b>	
Express Card	Abcom 5-in-1 Adapter ExpressCard Reader Abcom GigaLan ExpressCard Sunix ECF2400 2 Ports 1394A ExpressCard
<b>Memory Card Test (SD/MS/MMC/SM/CF/Microdrive/XD)</b>	
SD Card	Apacer 128/256MB SanDisk 256MB Apacer 2GB (150x Hi-Speed) KINGMAX 1GB (66x Hi-Speed) SanDisk 1GB RiDATA 4GB SD PRO Memory Card
MS Card	Sony 512 MS PRO Lexar 512MB MS PRO Lexar 1GB MS PRO Sony 2GB MS PRO
MMC Card	SanDisk 32MB Transcend 64/128MB Transcend 256MB SanDisk RS-MMC 128MB PQI RS-MMC 256MB Transcend 512MB A-DATA Turbo 200X 2GB MMC Card
XD Card	Apacer 256/512MB SanDisk 2GB Olympus 512MB
CF Card	Apacer 256/512 SanDisk 2GB



# Online Support Information

---

This section describes online technical support services available to help you repair your Acer Systems.

If you are a distributor, dealer, ASP or TPM, please refer your technical queries to your local Acer branch office. Acer Branch Offices and Regional Business Units may access our website. However some information sources will require a user i.d. and password. These can be obtained directly from Acer CSD Taiwan.

Acer's Website offers you convenient and valuable support resources whenever you need them.

In the Technical Information section you can download information on all of Acer's Notebook, Desktop and Server models including:

- Service guides for all models
- User's manuals
- Training materials
- Bios updates
- Software utilities
- Spare parts lists
- TABs (Technical Announcement Bulletin)

For these purposes, we have included an Acrobat File to facilitate the problem-free downloading of our technical material.

Also contained on this website are:

- Detailed information on Acer's International Traveler's Warranty (ITW)
- Returned material authorization procedures
- An overview of all the support services we offer, accompanied by a list of telephone, fax and email contacts for all your technical queries.

We are always looking for ways to optimize and improve our services, so if you have any suggestions or comments, please do not hesitate to communicate these to us.



**A**

AFLASH Utility 51  
Antennas 129

**B**

Battery Pack 60  
BIOS  
    package 31  
    password control 31  
    ROM size 31  
    ROM type 31  
    vendor 31  
    Version 31  
BIOS Supports protocol 31  
BIOS Utility 39–51  
    Advanced 42  
    Boot 49  
    Exit 50  
    Navigating 39  
    Onboard Device Configuration 45  
    Power 47  
    Save and Exit 50  
    Security 44  
    System Security 50  
Bluetooth board 101  
Board Layout  
    Top View 169  
brightness  
    hotkeys 15

**C**

Cache  
    controller 32  
    size 32  
Camera Module 123  
caps lock  
    on indicator 10  
Common Problems 152  
computer  
    on indicator 10, 11  
CPU 112

**D**

DIMM Module 65  
Display 4  
display  
    hotkeys 15

**E**

EasyTouch Failure 164  
Euro 16  
External Module Disassembly  
    Flowchart 59

**F**

Features 1  
Fingerprint Reader Failure 165  
Flash Utility 51  
FPC Cable 126  
FRU (Field Replaceable Unit) List 173

**H**

Hard Disk Drive Module 68  
HDTV Switch Failure 166  
Hibernation mode  
    hotkey 15  
Hot Keys 13

**I**

Indicators 10  
Intermittent Problems 168  
Internal Microphone Failure 158  
Internal Speaker Failure 156  
inverter board 121

**J**

Jumper and Connector Locations 169  
    Top View 169

**K**

Keyboard 76  
Keyboard Failure 155

**L**

---

Launch Board 93

LCD Bezel 119

LCD Brackets 126

LCD Failure 155

LCD Module Disassembly  
Flowchart 118

LCD Panel 125

lower cover 63

## M

Main Unit Disassembly  
Flowchart 73

Mainboard 106

media access  
on indicator 10

MediaTouch Button Failure 165

Memory Check 152

Model Definition 182

Modem Board 103

Modem Failure 163

## N

No Display Issue 153

Notebook Manager  
hotkey 15

num lock  
on indicator 10

## O

ODD Failure 160

Online Support Information 209

optical drive module 70

## P

Panel 5  
Bottom 9  
left 5

PC Card 10

Power On Failure 152

## S

Speaker Module 95  
speakers

hotkey 15

System

Block Diagram 4

## T

Test Compatible Components 205

Thermal Unit Failure 166

Top 169

Touch Pad  
hotkey 15

Touch Pad Board Plate 98

Touch Pad Bracket 88

Touch Pad Failure 156

Troubleshooting  
Built-in KB Failure 155  
EasyTouch Buttons 164  
Fingerprint Reader 165  
HDTV Switch 166  
Internal Microphone 158  
Internal Speakers 156  
LCD Failure 155  
MediTouch Buttons 165  
Modem 163  
No Display 153  
ODD 160  
Other Failures 167  
Power On 152  
Thermal Unit 166  
Touch Pad 156  
USB 163  
WLAN 164

## U

Undetermined Problems 168

USB Failure (Rightside) 163

utility  
BIOS 39–51

## W

Windows 2000 Environment Test 206

Wireless Function Failure 164

WLAN Board 66