

Acer Extensa 2000/2500 Series

Service Guide

PRINTED IN TAIWAN

Revision History

Please refer to the table below for the updates made on Extensa 2000/2500 service guide.

Date	Chapter	Updates

Copyright

Copyright © 2004 by Acer Incorporated. All rights reserved. No part of this publication may be reproduced, transmitted, transcribed, stored in a retrieval system, or translated into any language or computer language, in any form or by any means, electronic, mechanical, magnetic, optical, chemical, manual or otherwise, without the prior written permission of Acer Incorporated.

Disclaimer

The information in this guide is subject to change without notice.

Acer Incorporated makes no representations or warranties, either expressed or implied, with respect to the contents hereof and specifically disclaims any warranties of merchantability or fitness for any particular purpose. Any Acer Incorporated software described in this manual is sold or licensed "as is". Should the programs prove defective following their purchase, the buyer (and not Acer Incorporated, its distributor, or its dealer) assumes the entire cost of all necessary servicing, repair, and any incidental or consequential damages resulting from any defect in the software.

Intel is a registered trademark of Intel Corporation.

Pentium and Pentium II/III are trademarks of Intel Corporation.

Other brand and product names are trademarks and/or registered trademarks of their respective holders.

Conventions

The following conventions are used in this manual:

Screen messages	Denotes actual messages that appear on screen.
NOTE	Gives bits and pieces of additional information related to the current topic.
WARNING	Alerts you to any damage that might result from doing or not doing specific actions.
CAUTION	Gives precautionary measures to avoid possible hardware or software problems.
IMPORTANT	Reminds you to do specific actions relevant to the accomplishment of procedures.

Preface

Before using this information and the product it supports, please read the following general information.

1. This Service Guide provides you with all technical information relating to the BASIC CONFIGURATION decided for Acer "global" product offering. To better fit local market requirements and enhance product competitiveness, your regional office MAY have decided to extend the functionality of a machine (e.g. add-on card, modem, or extra memory capability). These LOCALIZED FEATURES will NOT be covered in this generic service guide. In such cases, please contact your regional offices or the responsible personnel/channel to provide you with further technical details.
2. Please note WHEN ORDERING FRU PARTS, that you should check the most up-to-date information available on your regional web or channel. If, for whatever reason, a part number change is made, it will not be noted in the printed Service Guide. For ACER AUTHORIZED SERVICE PROVIDERS, your Acer office may have a DIFFERENT part number code to those given in the FRU list of this printed Service Guide. You MUST use the list provided by your regional Acer office to order FRU parts for repair and service of customer machines.

Table of Contents

Chapter 1	System Introduction	1
	Features	1
	System Block Diagram	3
	Board Layout	4
	Top View	4
	Bottom View	5
	Panel	6
	Front Panel	6
	Left Panel	7
	Right Panel	8
	Rear Panel	9
	Bottom Panel	10
	Indicators	11
	Understanding the icons	12
	Keyboard	13
	Special keys	13
	Hot Keys	15
	Hardware Specifications and Configurations	18
Chapter 2	System Utilities	32
	BIOS Setup Utility	32
	Navigating the BIOS Utility	33
	Information	34
	Main	35
	Advanced	37
	Security	39
	Boot	43
	Exit	44
	BIOS Flash Utility	45
Chapter 3	Machine Disassembly and Replacement	46
	General Information	47
	Before You Begin	47
	Disassembly Procedure Flowchart	48
	Removing the Battery	50
	Removing the Memory Module	51
	Removing the Wireless LAN Board and the Modem Board	52
	Removing the Hard Disk Drive Module	53
	Disassembling the Hard Disk Drive Module	53
	Removing the LCD Module	54
	Removing the Middle Cover	54
	Removing the Launch Board	54
	Removing the LCD Module	55
	Disassembling the LCD Module	57
	Removing the LCD Bezel	57
	Removing the Inverter Board (15" LCD)	57
	Removing the 15" TFT LCD	58
	Removing the LCD Brackets	58
	Removing the LCD Coaxial Cable	59
	Removing the LCD Hinges	59
	Disassembling the Main Unit	61
	Removing the Keyboard	61

Table of Contents

Removing the RTC Battery	61
Removing the Fan	61
Removing the Thermal Module	62
Removing the Processor	62
Installing the Processor	63
Removing the Upper Case Assembly	63
Removing the Touchpad Board	64
Removing the Touchpad Cable	64
Removing the Floppy Disk Drive Module	65
Disassembling the Floppy Disk Drive Module	65
Removing the VGA Thermal Plate	66
Removing the CPU Heatsink Plate	66
Removing the Second Fan Bracket	67
Removing the ODD Module(1)	67
Removing the ODD Module(2)	67
Removing the HDD Bracket	68
Removing the Main Board	68
Removing the DC Board	69
Removing the I/O Port Bracket	69
Removing the PCMCIA Slot	70
Removing the Speaker Set	71
System Upgrade Procedure	72
Base Unit to Wireless Unit	72
Chapter 4 Troubleshooting	74
System Check Procedures	75
External Diskette Drive Check	75
External CD-ROM Drive Check	75
Keyboard or Auxiliary Input Device Check	75
Memory check	76
Power System Check	76
Touchpad Check	78
Power-On Self-Test (POST) Error Message	79
Index of Error Messages	80
POST Code	83
Index of Symptom-to-FRU Error Message	87
Intermittent Problems	90
Undetermined Problems	91
How to Build NAPP Master Hard Disc Drive	92
CD to Disk Recovery	92
Disk to Disk Recovery	95
Chapter 5 Jumper and Connector Locations	100
Top View	100
Bottom View	102
Chapter 6 FRU (Field Replaceable Unit) List	104
Extensa 2000/2500 Exploded Diagram	105
Appendix A Model Definition and Configuration	126
Model Name Definition	126

Appendix B Test Compatible Components	128
Microsoft Windows XP Environment Test	129
Appendix C Online Support Information	134
Index	136

System Introduction

Features

This computer was designed with the user in mind. Here are just a few of its many features:

Performance

- Intel® Pentium® 4 (for Extensa 2500) and Intel® Celeron® (for Extensa 2000) processors, 2.80GHz and above
- Intel® Hyper-Threading™ Technology
- 256/512MB of DDR333 SDRAM, upgradeable to 2048 MB with dual soDIMM modules
- High-capacity, Enhanced-IDE hard disk

Display

- The 14.1" or 15" XGA (1024x768 resolution), or 15.0" SXGA+ (1400x1050 resolution) TFT LCD panel providing a large viewing area for maximum efficiency and ease-of-use
- 3D graphics support
- Support for simultaneous display between LCD and CRT
- S-video for output to a television or display device that supports S-video input
- "Automatic LCD dim" feature, automatically selecting the best setting for the display in order to conserve power
- Dual independent display support

Multimedia

- High-speed built-in optical drive:
DVD-RW, DVD/CD-RW Combo, or DVD-Dual
- MS DirectSound compatible
- Built-in dual speakers

Connectivity

- Integrated 10/100 Mbps Fast Ethernet connection
- Built-in 56kbps fax/data modem
- Four Universal Serial Bus (USB) 2.0 ports
- IEEE 802.11b or IEEE 802.11g Wireless LAN (manufacturing option)
- Bluetooth (manufacturing option)

Expansion

- PC Card slots enabling a range of add-on options
- Upgradeable hard disk and memory modules

I/O Ports

- Two Type II or one Type III PC CardBus (PCMCIA) slot
- One FIR port
- One RJ-11 modem jack (V.92, 56K)

-
- One RJ-45 network jack
 - One DC-in jack
 - One parallel port (ECP/EPP)
 - One external monitor port
 - One microphone-in jack (3.5mm mini jack)
 - One headphone jack (3.5mm mini jack)
 - Four USB 2.0 ports

System Block Diagram

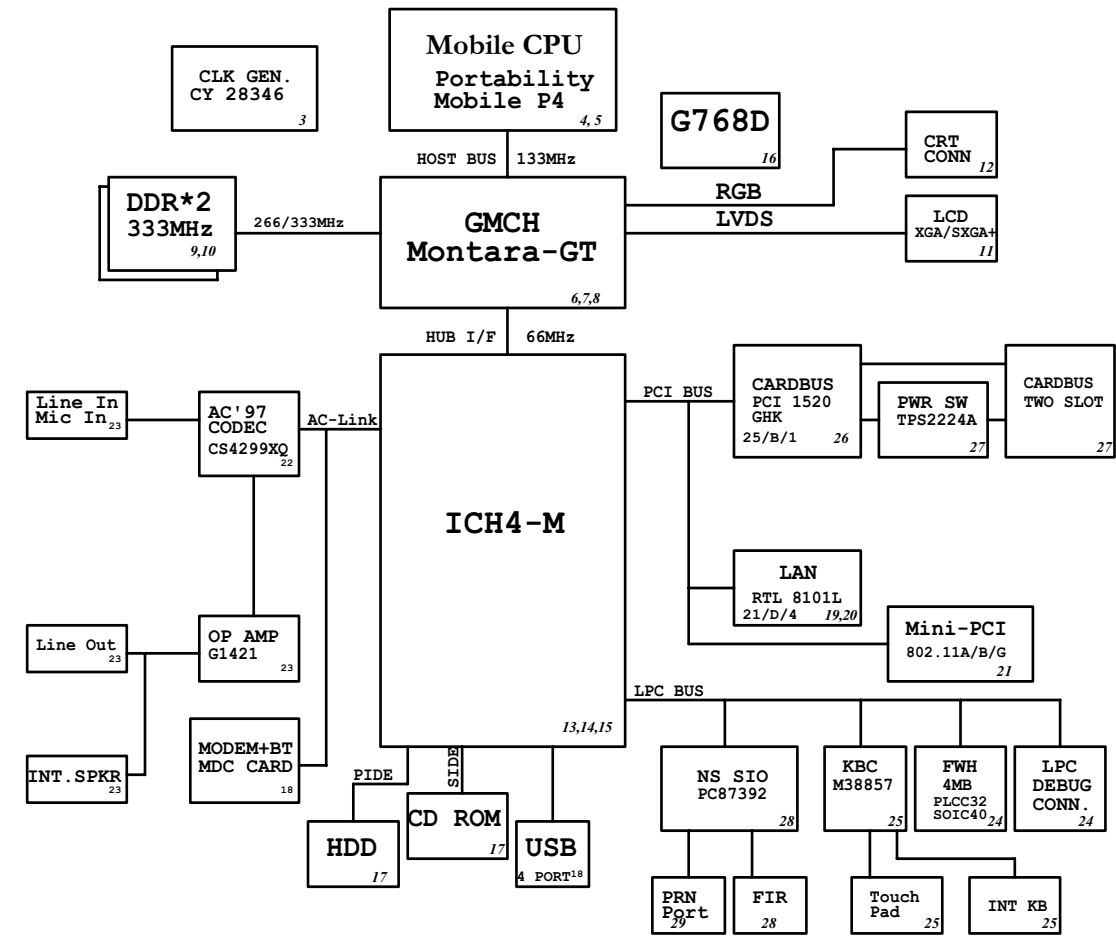

Board Layout

Top View

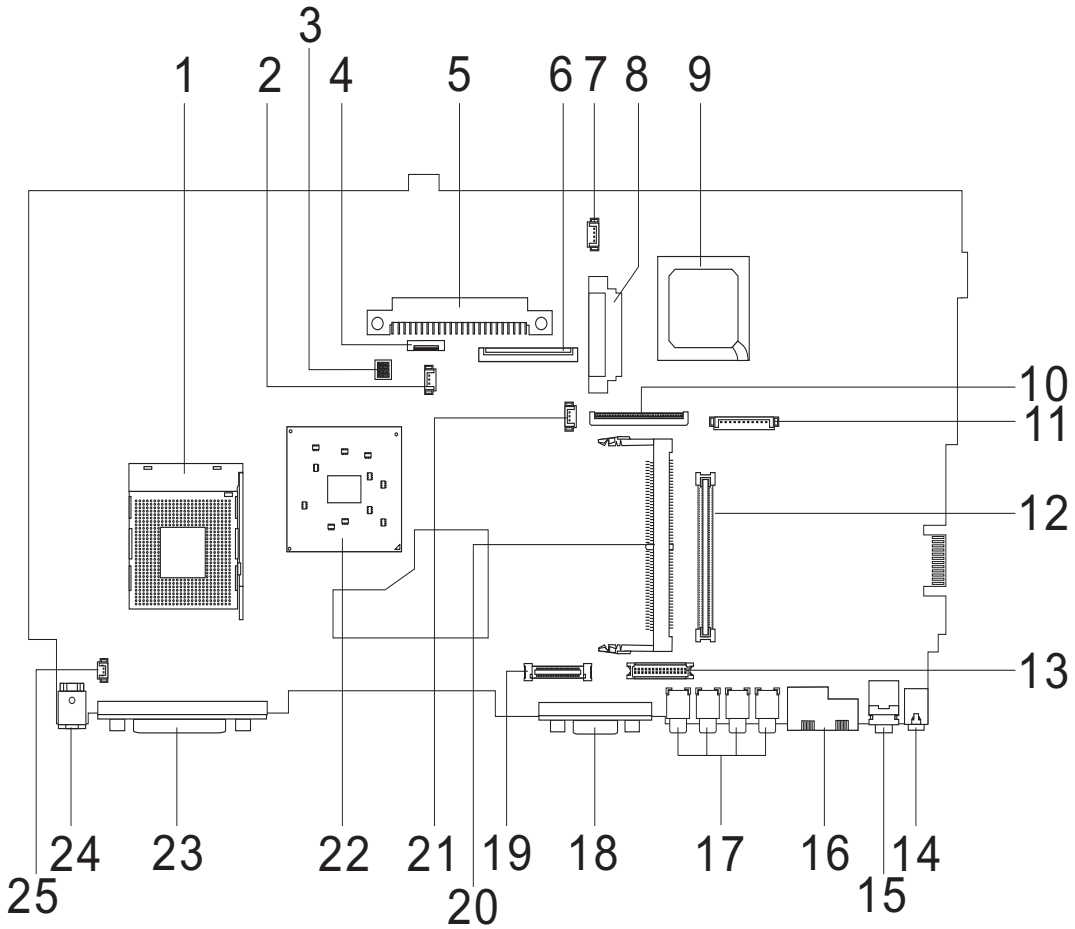

- | | | | |
|----|--|----|-----------------------------|
| 1 | CPU Socket | 14 | Line-in Port |
| 2 | Fan Connector | 15 | Line-out Port |
| 3 | SW1 (Please see Chapter 5 for detailed settings) | 16 | RJ45+RJ11 |
| 4 | Touchpad Cable Connector | 17 | Four USB Ports |
| 5 | HDD Connector | 18 | VGA Port |
| 6 | Keyboard Connector | 19 | LCD Coaxial Cable Connector |
| 7 | Speaker Cable Connector | 20 | Mini PCI Connector |
| 8 | Optical Drive Connector | 21 | RTC Battery Connector |
| 9 | South Bridge | 22 | North Bridge |
| 10 | FDD Connector | 23 | Parallel Port |
| 11 | Launch Cable Connector | 24 | DC-in Port |
| 12 | PCMCIA Slot | 25 | LCD Lid Switch |
| 13 | LCD Inverter Cable Connector | | |

Bottom View

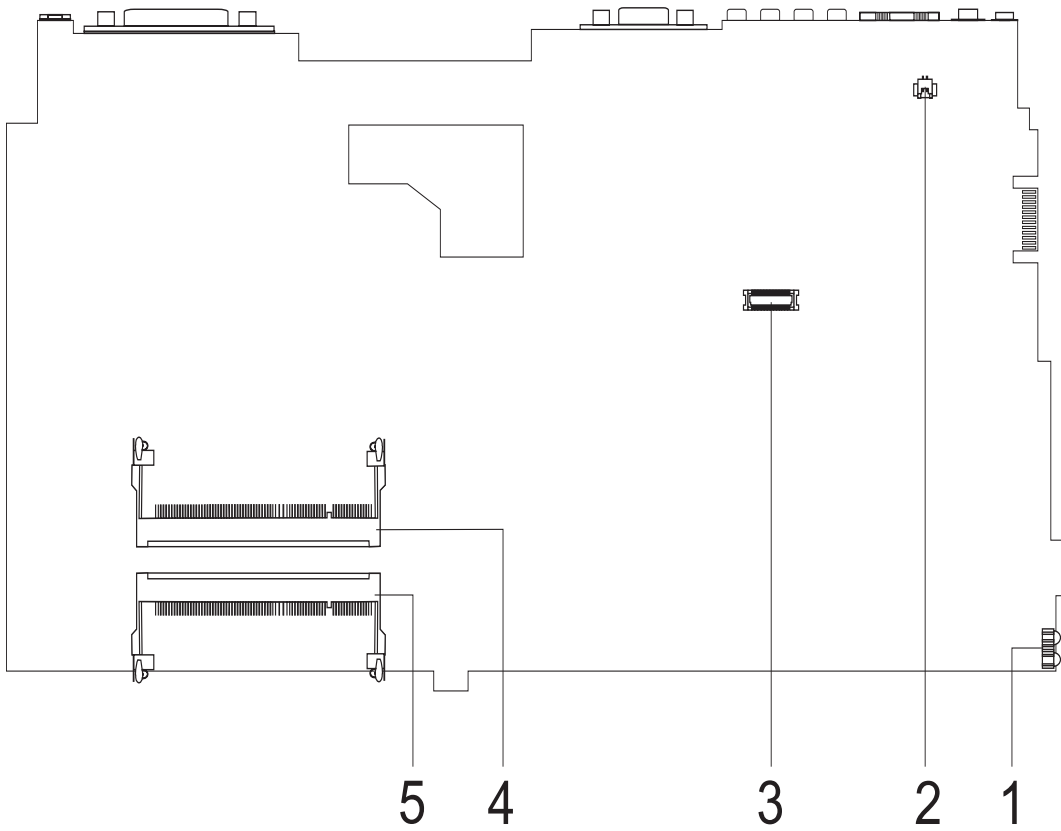

- 1 FIR Port
- 2 Modem Cable Connector
- 3 Modem Card Connector
- 4 DIMM Socket 2
- 5 DIMM Socket 1

Panel

Ports allow you to connect peripheral devices to your computer as you would with a desktop PC.

Front Panel



#	Item	Description
1	Display screen	Also called LCD (Liquid Crystal Display), displays computer output.
2	Status indicators	LEDs (Light Emitting Diodes) that turn on and off to show the status of the computer and its functions and components.
3	Power button	Turns on the computer power.
4	Launch Keys	Buttons for launching frequently used programs. See “Launch keys” on page 17 for more details.
5	Palmrest	Comfortable support area for your hands when you use the computer.
6	Click buttons (left, center and right)	The left and right buttons function like the left and right mouse buttons, the center button serves as a 4-way scroll button.
7	Touchpad	Touch-sensitive pointing device which functions like a computer mouse.
8	Keyboard	Inputs data into your computer.
9	Ventilation Slot	Enables the computer to stay cool, even after the prolonged use.

Left Panel



#	Icon	Item/ Port	Description
1		PCMCIA (PC card) Port	Connects to one Type III 16-bit PC card or 32-bit CardBus PC Card.
2		Eject button	Eject the PC cards from the slot.
3		Optical drive	Internal optical drive; accepts CDs or DVDs depending on the optical drive type.
4		Infrared port	Interfaces with infrared devices (e.g., infrared printer, IR-aware computer).
5		Eject button	Ejects the optical drive tray from the drive.
6		LED indicator	Lights up when the optical drive is active.
7		Emergency eject slot	Ejects the optical drive tray when the computer is turned off. There is a mechanical eject button on the CD-ROM or DVD-ROM drive. Simply insert the tip of a pen or paperclip and push to eject the tray.
8		Speaker	Delivers stereo audio output.

Right Panel



#	Icon	Item/ Port	Description
1		Speaker	Delivers stereo audio output.
2		Ventilation slots	Enable the computer to stay cool, even after prolonged use.
3		Security keylock	Connects to a Kensington-compatible computer security lock.

Rear Panel

I



#	Icon	Port	Description
1		Power Jack	Connects to an AC adapter
2		Parallel port	Connects to a parallel device (e.g., parallel printer).
3		Ventilation slot	Enables the computer to stay cool, even after prolonged use.
4		External display port	Connects to a display device (e.g., external monitor, LCD projector) and displays up to 16M colors(with FRC technology) at 1024x768 resolution
5		USB port (four)	Connects to Universal Serial Bus (USB) 2.0 devices(e.g., USB mouse, USB camera).
6		Network jack	Connects to an Ethernet 10/100-based network
7		Modem jack	Connects to the phone line
8		Speaker/Line-Out/Headphone jack	Connects to audio line-out devices (e.g., speakers, headphone).
9		Line-in/Mic-in jack	Accepts audio line-in devices (e.g., audio CD player, stereo walkman).

Bottom Panel

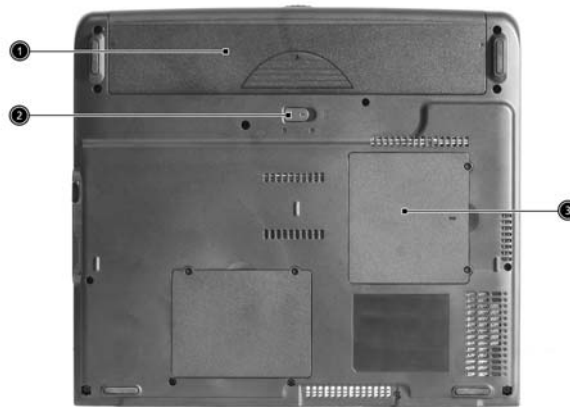







#	Item	Description
1	Battery bay	Houses the computer's battery pack.
2	Battery release latch	Unlatches the battery to remove the battery pack.
3	Memory compartment	Houses the computer's main memory.

Indicators

The computer has seven easy-to-read status icons on the right of the display screen.



The Power and Standby status icons are visible even when you close the display cover so you can see the status of the computer while the cover is closed.

#	Icon	Function	Description
1		Wireless communication button	Lights when the Wireless LAN capability is enabled.
2		Power	Lights when the computer is on.
3		Sleep	Lights when the computer enters Standby mode and blinks when it enters into or resumes from hibernation mode.
4		Media Activity	Lights when the floppy drive, hard disk or optical drive is active.
5		Battery Charge	Lights when the battery is being charged.
6		Caps Lock	Lights when Caps Lock is activated.
7		Num Lock (Fn-F11)	Lights when Numeric Lock is activated.

Understanding the icons

When the cover of your computer is closed, 2 easy-to-read icons are shown, indicating which state or feature is enabled or disabled.



#	Icon	Function	Description
1		Power	Lights up when the computer is on.
2	Z^Z	Sleep	Lights when the computer enters Standby mode and blinks when it enters into or resumes from hibernation mode.

Keyboard







The keyboard has full-sized keys and an embedded keypad, separate cursor keys, two Windows keys and twelve function keys.

Special keys

Lock keys

The keyboard has three lock keys which you can toggle on and off.



Lock key	Description
Caps Lock 	When  is on, all alphabetic characters typed are in uppercase.
Num Lock (Fn-F11) 	When  is on, the embedded keypad is in numeric mode. The keys function as a calculator (complete with the arithmetic operators), -, *, and /). Use this mode when you need to do a lot of numeric data entry. A better solution would be to connect an external keypad.
Scroll Lock (Fn-F12) 	When  is on, the screen moves one line up or down when you press the up or down arrow keys respectively.  does not work with some applications.

Embedded numeric keypad

The embedded numeric keypad functions like a desktop numeric keypad. It is indicated by small characters located on the upper right corner of the keycaps. To simplify the keyboard legend, cursor-control key symbols are not printed on the keys.











Desired access	Num lock on	Num lock off
Number keys on embedded keypad	Type numbers in a normal manner.	
Cursor-control keys on embedded keypad	Hold Shift while using cursor-control keys.	Hold Fn while using cursor-control keys.
Main keyboard keys	Hold Fn while typing letters on embedded keypad.	Type the letters in a normal manner.

NOTE: If an external keyboard or keypad is connected to the computer, the Num Lock feature automatically shifts from the internal keyboard to the external keyboard or keypad.

Windows keys

The keyboard has two keys that perform Windows-specific functions.



Keys	Description
Windows logo key 	Start button. Combinations with this key perform shortcut functions. Below are a few examples:  + Tab (Activates next taskbar button)  + E (Explores My Computer)  + F (Finds Document)  + M (Minimizes All)  +  + M (Undoes Minimize All)  + R (Displays the Run... dialog box)
Application key 	Opens a context menu (same as a right-click).











Hot Keys

The computer employs hot keys or key combinations to access most of the computer's controls like screen contrast and brightness, volume output and the BIOS Utility.

To activate hot keys, press and hold the **Fn** key before pressing the other key in the hot key combination.



Hot Key	Icon	Function	Description
Fn-F1	?	Hotkey help	Displays a list of the hotkeys and their functions.
Fn-F2		Setup	Accesses the notebook configuration utility.
Fn-F3		Power Management Scheme Toggle	Switches between the power management scheme used by the computer (function available if supported by operating system).
Fn-F4	Z ^z	Sleep	Puts the computer in Sleep mode.
Fn-F5		Display toggle	Switches display output between the display screen, external monitor (if connected) and both the display screen and external monitor.
Fn-F6		Screen blank	Turns the display screen backlight off to save power. Press any key to return.
Fn-F7		Touchpad Toggle	Turns the internal touchpad on and off.
Fn-F8		Speaker on/off	Turns the speakers on and off; mutes the sound.
Fn-↑		Volume up	Increases the sound volume.
Fn-↓		Volume down	Decreases the sound volume.
Fn-→		Brightness up	Increases the screen brightness.

Hot Key	Icon	Function	Description
Fn- 		Brightness down	Decreases the screen brightness.
Fn- 	Pg Up 	Home	Functions as the  key.
Fn- 	Pg Dn 	End	Functions as the  key.
 Gr-Euro		Euro	Types the Euro symbol.

The Euro symbol

If your keyboard layout is set to United States-International or United Kingdom or if you have a keyboard with a European layout, you can type the Euro symbol on your keyboard.

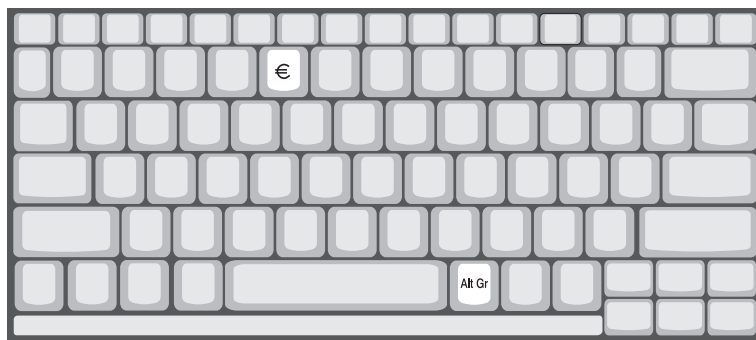

NOTE: for US keyboard users: The keyboard layout is set when you first set up Windows. For the Euro symbol to work, the keyboard layout has to be set to United States-international.

To verify the keyboard type:

1. Click on **Start, Control Panel**.
2. Double-click on **Regional and Language Options**.
3. Click on the **language** tab and click on **Details**.
4. Verify that the keyboard layout used for "EN English (United States) is set to United States-International.

If not, select and click on **ADD**, then select **United States-International** and click on **OK**.

5. Click on **OK**.





To type the Euro symbol:

1. Locate the Euro symbol on your keyboard.
2. Open a text editor or word processor.
3. Hold  Gr and press the Euro symbol.

Launch Keys

Located at the top of the keyboard are six buttons. These buttons are called launch keys. They are designated as mail button, Web browser button, P1, P2, Bluetooth and Wireless buttons. The Wireless and Bluetooth buttons cannot be set by the user. To set the other four launch keys, run the Acer Launch Manager.



#	Icon	Function	Description
1		Mail	Email application
2		Web browser	Internet browser application
3	P1	P1	User-programmable
4	P2	P2	User-programmable
5		Bluetooth	Starts (optional) Bluetooth functionality and indicates that (optional) Bluetooth is enabled.
6		Wireless	Opens (optional) wireless connectivity and indicates status of (optional) wireless communication.

Hardware Specifications and Configurations

System Board Major Chips

Item	Controller
System core logic	Intel ICH4-M
Super I/O controller	NS PC87392
Audio controller	Cirrus logic CS4299-XQ
Video controller	Intel 852GME (Montara-GT)
Hard disk drive controller	Embedded in Intel ICH4
Keyboard controller	Mitsubish LPC keyboard controller M38857
CardBus Controller	TI 1520
RTC	Intel ICH4

Processor (for TravelMate 240)

Item	Specification
CPU type	Intel Celeron processor
CPU package	To 2.0GHz uFCBGA
CPU core voltage	High speed: 1.525V or 1.55V Low speed: 1.2V
CPU I/O voltage	High speed: 1.525V or 1.55V Low speed: 1.2V

Processor (for TravelMate 250)

Item	Specification
CPU type	Intel Petium 4 processor
CPU package	To 2.4GHz uFCBGA
CPU core voltage	1.525V
CPU I/O voltage	1.525V

BIOS

Item	Specification
BIOS vendor	Phoenix BIOS
BIOS Version	TM240 V1.00 for TM240; TM250 V1.00 for TM250
BIOS ROM type	Flash ROM
BIOS ROM size	512KB
BIOS package	32 Pin PLCC
Supported protocols	ACPI 2.0 (if available, at least 1.0b), SMBIOS 2.3, PCI 2.2, Boot Block, PXE 2.0, Mobile PC2001, Hard Disk Password, INT 13h Extensions, PCI Bus Power Management interface Specification, EI Torito-Bootable CD-ROM Format Specification V1.0, Simple Boot Flag 1.0
BIOS password control	Set by switch, see SW1 settings

Second Level Cache

Item	Specification
Cache controller	Built-in CPU

Second Level Cache

Item	Specification
Cache size	128KB for TM240/512KB for TM250
1st level cache control	Always Enabled
2nd level cache control	Always Enabled
Cache scheme control	Fixed-in write back

System Memory

Item	Specification
Memory controller	Intel 852GME (Montara-GT)
Onboard memory size	0MB
DIMM socket number	2 Sockets
Supports memory size per socket	128MB
Supports maximum memory size	2048MB
Supports DIMM type	DDR-DRAM
Supports DIMM Speed	266 MHz/333 MHz
Supports DIMM voltage	2.5 V
Supports DIMM package	200-pin so-DIMM
Memory module combinations	You can install memory modules in any combinations as long as they match the above specifications .

Memory Combinations

Slot 1	Slot 2	Total Memory
0MB	128MB	128 MB
128MB	0MB	128 MB
128MB	128MB	256 MB
256MB	0MB	256MB
0MB	256MB	256MB
256MB	128MB	384MB
128MB	256MB	384MB
256MB	256MB	512MB
0MB	512MB	512MB
512MB	128MB	640MB
256MB	512MB	768MB
128MB	512MB	640MB
512MB	256MB	768MB
256MB	128MB	384MB
512MB	512MB	1024MB
0MB	512MB	512MB
1024MB	0MB	1024MB
1024MB	128MB	1152MB
1024MB	256MB	1280MB
1024MB	512MB	1536MB
0MB	1024MB	1024MB
128MB	1024MB	1152MB
256MB	1024MB	1280MB

Memory Combinations

Slot 1	Slot 2	Total Memory
512MB	1024MB	1536MB

Above table lists some system memory configurations. You may combine DIMMs with various capacities to form other combinations.

LAN Interface

Item	Specification
Chipset	RealTek 8101L
Supports LAN protocol	10/100Mbps
LAN connector type	RJ45
LAN connector location	Rear side

Modem Interface

Item	Specification
Chipset	Internal Agere Scorpio chipset (Scorpio+CSP1037B)
Fax modem data baud rate (bps)	14.4K
Data modem data baud rate (bps)	56K
Supports modem protocol	V.90/V.92MDC
Modem connector type	RJ11
Modem connector location	Rear side

Floppy Disk Drive Interface

Item	Specification		
Vendor & model name	Mitsumi D353G 4515 MCI JU-226A033FC		
Floppy Disk Specifications			
Media recognition	2DD (720KB)	2HD (1.2 MB, 3 mode)	2HD (1.44MB)
Sectors/track	9	15	18
Tracks	80	80	80
Data transfer rate (Kbit/s)	1 MB	1.6 MB	2 MB
Rotational speed (RPM)	300	360	300
Read/write heads	2		
Encoding method	MFM		
Power Requirement			
Input Voltage (V)	+5V		

Hard Disk Drive Interface

Item			
Vendor & Model Name	HGST Moraga IC25N030ATMR04 Fujitsu V-40 MHT2030AT Seagate N1 ST93015A	HGST Moraga IC25N040ATMR04- TOSHIBA Pluto 40G MK4025GAS Fujitsu V40+ MHT2040AT Seagate N1 ST94019A	HGST Moraga IC25N060ATMR04-0 HGST Fresno DK23FA-60 TOSHIBA Neptune MK6021GAS
Capacity (MB)	30000	40000	60000

Hard Disk Drive Interface

Item			
Bytes per sector	512	512	512
Logical heads	16	16	16
Logical sectors	63	63	63
Drive Format			
Logical cylinders	16383	16383	16383
Physical read/write heads	2/Not show/2	2/Not show/2/2	3/
Disks	1/Not show/1	1/Not show/1/1	2
Spindle speed (RPM)	4200RPM	4200RPM	4200RPM
Performance Specifications			
Buffer size	2MB	2MB/8MB for Toshiba	2MB
Interface	ATA-5 for other vendors /ATA-6 for HGST and Toshiba	ATA-5 for other vendors /ATA-6 for HGST	ATA-5 for other vendors /ATA-6 for HGST
Data transfer rate (disk-buffer, Mbytes/s)	350	350	350
Data transfer, rate (host~buffer, Mbytes/s)	100 MB/Sec	100 MB/Sec	100MB/Sec
DC Power Requirements			
Voltage tolerance	5 +/- 5%	5 +/- 5%	

CD-ROM Interface

Items	Specification
Vendor & Model Name	QSI SCR242 Mitsumi SR244W1
Performance Specification	
Burst Data Transfer rate	PIO mode 4: 16.7 MB/sec Max. (Mode 0~4) Multi-word DMA mode 2: 16.7 MB/sec Max. (Mode 0~2) Ultra DMA mode 2: 33.3MB/sec Max.
Access time (typ.)	QSI- Random: 90 ms Full Stroke: 180 ms Mitsumi- Random: 100 ms Full Stroke: 240 ms
Rotation speed	5100 rpm for QSI 5400 rpm for Mitsumi 24X CAV mode
Data Buffer Capacity	128 KB (built-in)
Interface	Compliant to ATA/ATAPI-6

CD-ROM Interface

Items	Specification
Applicable disc format	<p>QSI: CD-DA, CD-ROM Mode-1, CD-ROM/XA Mode-2, Form-1 and Mode-2 Form-2, CD-i Ready, Video-CD (MPEG-1), Karaoke CD, Photo-CD, Enhanced CD, CD Plus, CD Extra, i-trax CD, CD-Text, CD-R and CD-RW</p> <p>Mitsumi: CD-DA, CD-ROM (Mode 1 and Mode2) CD-ROM XA (Mode 2 Form 1 and Form2), CD-I (Mode2 Form 1 and Form 2), CD-I Bridge (Photo CD, CD EXTRA), Enhanced CD, CD-RW, CD-R, CD-TEXT</p>
Loading mechanism	Drawer with soft eject and emergency eject hole
Power Requirement	
Input Voltage	+5V[DC]±5%

DVD-ROM Interface

Item	Specification	
Vendor & model name	MKE SR-8177	
Performance Specification	With CD Diskette	With DVD Diskette
Transfer rate (KB/sec)	Average Sustained: CAV mode 775~1800 blocks/sec (10.3X to 24X) 1550~3600kBytes/sec (Mode 1) 1768~4106 kBytes/sec (Mode 2)	DVD-5: Normal Speed (1X) 11.08 Mbits/sec CAV mode 36.67~88.64 Mbits/sec DVD-9/DVD-R: Normal Speed (1X) 11.08 Mbits/sec CAV mode 36.67~88.64 Mbits/sec
Average Full Access time (typ.)	Random CAV mode 110 msec typical 150 msec average max Full Stroke CAV mode 200 msec typical 260 msec average max	DVD-5: Random 120 msec typical 160 msec average max Full Stroke 270 msec typical 350 msec average max DVD-9: Random 150 msec typical 200 msec average max Full Stroke 340 msec typical 450 msec average max DVD-RAM (2.6G) Random 200 msec typical 300 msec average max Full Stroke 300 msec typical 600 msec average max DVD-RAM (4.7G) Random 180 msec typical 300 msec average max Full Stroke 320 msec typical 700 msec average max
Data Buffer Capacity	512 kBytes	
Interface	IDE	

DVD-ROM Interface

Item	Specification
Applicable disc format	DVD: DVD-5, DVD-9, DVD-10, DVD-R (3.95G), DVD-RAM (2.6G), DVD-RAM (4.7G) CD: CD-Audio, CD-ROM (mode 1 and mode 2), CD-ROM XA (mode 2, form 1 and form 2), CD-I (mode 2, form 1 and form 2), CD-I Ready, CD-I Bridge, CD-WO, CD-RW, Photo CD, Video CD, Enhanced Music CD, CD-TEXT
Loading mechanism	Soft eject (with emergency eject hole)
Power Requirement	
Input Voltage	+5V[DC]±5%

Combo Drive Interface

Item	Specification
Vendor & model name	KME UJDA750
Performance Specification	
Transfer rate (KB/sec)	Read Sustained: DVD-ROM MAX 8X CAV (MAX 10800 KB/sec) CD-ROM MAX 24X CAV (MAX 3600 KB/sec) Write: CD-R 4X, 8X (CLV), Max 16X, MAX 24X (ZCLV) CD-RW 4X (CLV) HS-RW 4X,8X, 10X (CLV) ATAPI Interface: PIO mode 16.6 MB/sec :PIO Mode 4 DMA mode 16.6 MB/sec:Multi word mode 2 Ultra DMA mode 33.3MB/sec: Ultra DMA mode 2
Buffer rate	2MB
Access time	DVD-ROM 180 ms typ. (1/3 stroke) CD-ROM 130 ms typ. (1/3 stroke)
Start up time	less than 15s
Stop time	less than 6s
Acoustic noise	less than 50 dBA
Interface	Enhanced IDE (ATAPI) compatible
Master/Slave	Set by Cable Select (By host)
PC compatible	PC2001 compatible
Applicable disc format	CD: CD-DA, CD-ROM, CD-ROM XA, CD-R, CD-RW, PhotoCD (multiSession), Video CD, CD-Extra(CD+), CD-text DVD: DVD-ROM, DVD-R, DVD-RW (Ver.1.1), DVD-VIDEO, DVD-RAM (2.6GB, 4.7GB)
Slope	15 degree (Any direction)
Dimensions, Weight	128X129X12.7mm (WDXH) (except protrusion) 200g± 10g
Eject	Soft Eject (with emergency eject hole)

DVD Dual Interface

Item	Specification
Vendor & model name	Liteon DVD-Dual SDW-431S

DVD Dual Interface

Item	Specification
Disc type for read/write application	
Applicable Formats	CD-DA, CD-TEXT, CD ROM Mode-1, CD-ROM/XA Mode-2 Form-1 and Form-2, CD-I Ready, Video-CD (MPEG-1), Karaoke-CD, Photo-CD, Enhance CD, CD extra, I-Trax CD and UDF DVD-ROM, DVD-Video, DVD-Audio, DVD-R single/multi border(s) DVD+R single/multi session(s) DVD-RW DVD+RW
Applicable Media Type	CD-ROM, CD-R and CD-RW DVD-ROM (4.7G/8.54G) single layer on single/double side (read only), DVD-ROM dual layer (PTP/OTP) on single/double side (read only) DVD-R (3.9G, 4.7G for General and Authoring), DVD-RW, DVD+RW (4.7G) DVD+R
Disc Diameter	12cm and 8cm
Capacity	2048 bytes/sector (DVD) 2048 bytes/block (CD Mode-1 and Mode-2 Form-1) 2336 bytes/block (Mode-2) 2328 bytes/block (Mode-2 Form-2)
Operation environment for "write/rewrite" application	
Host Machine	IBM compatible PC (Pentium 166 MHz or above)
OS	MS-Windows 90/ME/2000/XP/NT 4.0
Memory	Min. 128MB required
Hard Disk	Empty Storage Capacity: 100 MB or more Average access time: 20ms or less
Disc Diameter	12cm and 8cm
Recommended Media	<p>CD-R: AMT, CMC, Csita, Delphi, EverMedia, Imation, LeadData(Silver-Sil), Maxell, MCC (Bagdad), Mirage, Mitsui, MoserBaer(India), MPO, NanYa, Plasmon, Prodisc, RAMedia, Ricoh, Ritek(JS, S, Richodye), SAST (ultra green), SKC(Korea), TDK, TY (DX dye)</p> <p>Low Speed CD-RW: CMC, Daxon, Fornet, Gigastorage, Imation, Infodisc, LeadData, MCC, Nanya, Princo, Prodisc, Ricoh, Ritek</p> <p>High Speed CD-RW: AMT, CMC, Infodisc, Nanya, Postech, Prodisc, Ritek, Ricoh, MCC, SKC(Korea)</p> <p>Ultra Speed CD-RW: Daxon, Imation, Infodisc, MCC, Prodisc, Ritek</p> <p>DVD+R: BEAll, CMC, Daxon, Fuji, HP, Maxell, MCC, Memorex, OPTODISC, PRODISC, Ricoh, RICOH, Ritek, SONY, TDK, TYUDE</p> <p>DVD+RW: CMMC, Daxon, Imation, MCC, Philips, Ricoh, Ritek, Sony</p> <p>DVD-R: BeAll, CMMC, DAXON, DVSN Fornex, GSC, Imation, LeadData, Maxell, Mitsubishi, Nanya, Pioneer, Princo, Prodisc, Ritec, Ritek, SKC, Sony, That's</p> <p>DVD-RW: CMC, Mitsubishi, Princo Ritek</p>
Mechanism	

DVD Dual Interface

Item	Specification
Pick-up	NA: CD: 0.51 DVD: 0.65 Focusing: Astigmatism Tracking: CD: DPP DVD-ROM: DPP DVD+R/RW: DPP Wave length: CD: 785+/- 5 nm DVD: 650+/- 15 nm Output power: Read CD: 1.5 mw max@objective lens DVD: 1.0 mw max Write CD: 65 mw max2@objective lens DVD: 20 mw max
Traverse mechanism	DC Stepping motor driven
Spindle motor	DC burshless motor
Loading mechanism	Manual load/DC brushless mortor system

Audio Interface

Item	Specification
Audio Controller	Cirrus Logic CS4299-XQ
Audio onboard or optional	Built-in
Mono or Stereo	Stereo
Resolution	20 bit stereo Digital to Analog converter 18 bit stereo Analog to Digital converter
Compatibility	Microsoft PC98/PC99, AC97 2.1
Mixed sound source	Line-in, CD, Video, AUX
Voice channel	8/16 bit, mono/stereo
Sampling rate	44.1 KHz
Internal microphone	Yes
Internal speaker / Quantity	Yes
Supports PnP DMA channel	DMA channel 0 DMA channel 1
Supports PnP IRQ	IRQ10, IRQ11

Video Interface

Item	Specification
Vendor & Model Name	Intel 845GME (Montara-GT)
Chip voltage	Core / 2.5V, 1.5V,
Supports ZV (Zoomed Video) port	NO
Graph interface	4X AGP (Accelerated Graphic Port) Bus
Maximum resolution (LCD)	1024 x768 (32bit colors)
Maximum resolution (CRT)	1024x768 (32 bit colors) 1280x1024 (32 bit colors) 1600x1200 (32 bit colors)

Video Memory

Item	Specification
Fixed or upgradeable	Fixed, share the system memory
Video memory size	8MB

Video Resolutions Mode

Resolution	Refresh Rate	
	CRT Only	LCD/CRT Simultaneous
640x480x256	90	60
640x480x64K	90	60
640x480x16M	90	60
800x600x256	90	60
800x600x64K	90	60
1024x768x256	90	60

Parallel Port

Item	Specification
Parallel port controller	NS PC87392
Number of parallel port	1
Location	Rear side
Connector type	25-pin D-type
Parallel port function control	Enable/Disable by BIOS Setup
Supports ECP/EPP	Yes (set by BIOS setup)
Optional ECP DMA channel (in BIOS Setup)	DMA channel 1 and 3
Optional parallel port I/O address (in BIOS Setup)	378, 278, 3BC
Optional parallel port IRQ (in BIOS Setup)	IRQ7, IRQ5

USB Port

Item	Specification
USB Compliancy Level	2.0
OHCI	USB 2.0
Number of USB port	4
Location	Rear side
Serial port function control	Enable/Disable by BIOS Setup

PCMCIA Port

Item	Specification
PCMCIA controller	TZ 1520
Supports card type	Type II, Tpye III
Number of slots	Two type II, one type III
Access location	Left side
Supports ZV (Zoomed Video) port	Yes

PCMCIA Port

Item	Specification
Supports 32 bit CardBus	Yes (IRQ17)

Keyboard

Item	Specification
Keyboard controller	Mitsubishi LPC keyboard controller M38857
Keyboard vendor & model name	API
Total number of keypads	84-/85- key
Windows 95 keys	Yes
Internal & external keyboard work simultaneously	Yes

Battery

Item	Specification
Vendor & model name	SIMPLO
Battery Type	Li-ION
Pack capacity	4000mAH
Cell voltage	3.8V / 1.2V
Number of battery cell	8
Package configuration	4529 / 8S
Package voltage	41.8V / 9.6V

DC-DC/Charger Converter

Item	Specification
Vendor & Model Name	MAX IM1645/MAXIM1715/MAX1 999/MAXI 545
Input Voltage	AC Adapter or Battery: 8V - 19VDC
DC-DC Converter Output	
Output Rating	+5V 3.3V
Current (w/load, A)	0~5A 0~4A
Charger Output	Li-ION
Normal charge (charge while system is not operative)	2.8A
Background charge (charge even system is still operative)	Constant power mode (2.8A~0A)
Battery-low 2 level (V)	12.5V
Battery-low 3 level (V)	11.5V
Protection	
Charger protection	Over Current Protection
DC/DC converter protection	OCP (Over Current Protection, A) OVP (Over Voltage Protection, V) UVP (Under Voltage Protection, V)

DC-AC LCD Inverter

Item	Specification
Vendor & model name	Ambit
Input voltage (V)	8 ~ 21V
Input current (mA)	1A (max.)
Output voltage (Vrms, no load)	1400Vrms
Output voltage frequency (kHz)	40 ~ 70KHz
Output Current/Lamp	5.5 mA ~ 6.5mA

NOTE: DC-AC inverter is used to generate very high AC voltage, then support to LCD CCFT backlight user, and is also responsible for the control of LCD brightness. Avoid touching the DC-AC inverter area while the system unit is turned on.

NOTE: There is an EEPROM in the inverter, which stores its supported LCD type and ID code. If you replace a new inverter or replace the LCD with a different brand, use Inverter ID utility to update the ID information.

LCD

Item	Specification		
Vendor & model name	14.1" AU B141XN04 V2	15" Hitachi TX38D85VC1CAB	15" AU B150PG01 SXGA+
Physical Specifications			
Display resolution(pixel)	1024(H) x 768(V)	1400(H) x1050(V)	1400(H) x1050(V)
Active area(mm)	285.7(H) x 214.3(V)	304.1(H) x 228.1(V)	304.5 (H) x228.375(V)
Screen Size(inch)	14.1	15.0	15.0
Pixel pitch(mm)	0.279(H)x 0.279(V)	0.297(H)x 0.297(V)	0.2175x 0.2175
Color configuration (Pixel Arrangement)	R.G.B. Vertical stripe		
Overall dimension(mm)	298.5(W)x226.7(H)x5.2/5.5(D)	317.3(w)x242.1(H)x6.0(D)	
Weight(g)	445+/-20	580	550
Surface treatment	Hard coating (3H), anti-glare of the front polarizer	Not show	Not show
Power supply(input voltage)	3.6V(max)	3.3V(typ.) 3.6V(max)	3.3V
Response time:Rising time/Falling time	20(typ.)40(max)/ 30(typ.)50(max)	30(typ.)50(max) 30(typ.)50(max)	15(typ.) 35(typ.)
Contrast ratio	250	200	250
Support colors	262K	262k	262K
Typical White Luminance	150	180	150

AC Adapter

Item	Specification
Vendor & model name	Liton
Input Requirements	
Maximum input current (A, @90Vac, full load)	1.5 A @ 110Vac 1.0 A @ 240Vac
Nominal frequency (Hz)	50-60

AC Adapter

Item	Specification
Frequency variation range (Hz)	47-63
Input voltage range (Vrms)	90-270
Inrush current	The maximum inrush current will be less than 50A and 100A when the adapter is connected to 115Vac and 230Vac respectively.
Efficiency	It should provide an efficiency of 80% minimum, when measured at maximum load under 115Vac.
Output Ratings (CV mode)	
DC output voltage	19V
Noise + Ripple	300mVp-pmax (20 MHz bandwidth)
Load	0(min) 3.16A(max)
Output Ratings (CC mode)	
DC output voltage	19V +/-1.0V for CV mode
Constant current mode	3.6 +/- 0.3A
Dynamic Output Characteristics	
Turn-on delay time	3 sec (@ 115Vac)
Hold up time	5ms (@115Vac, Full load)
Over Voltage Protection (OVP)	24V
Short circuit protection	3.9A max can be protected and output can be shorted without damage
Electrostatic discharge (ESD)	15KV (at air discharge) 8KV (at contact discharge)
Dielectric Withstand Voltage	
Primary to secondary	3000Vac
Leakage current	0.25 mA max. (@ 254Vac, 60Hz)
Regulatory Requirements	<p>Safety Requirements:</p> <ol style="list-style-type: none"> 1.The subject product rated 100-120V 60Hz must be listed under UL 1950 and certified with SCA Standard C22.2 No.950. 2.The subject product rated 200-240V 50Hz must comply with low voltage directive 73/23EEC. <p>EMI Requirements:</p> <ol style="list-style-type: none"> 1.The subject product rated 100-120V 60Hz must meet the EMI requirements of FCC part 15, Subpart B for Class B Digital Device and get FCC Certification before marketing into USA and Canada. 2.The subject product rated 200-240V 50Hz must meet the EMC Directive 89/336/EEC. 3.The subject product rated 100-120V must meet the VCCI-2 EMI requirements.

Power Management

Power Saving Mode	Phenomenon
<p>Standby Mode</p> <p>Enter Standby Mode when</p> <ol style="list-style-type: none"> 1.Standby/Hibernation hot-key is pressed and system is not ready to enter Hibernation mode. 2.System standby/ Hibernation timer expires and system is not ready to enter Hibernation mode. 	<input type="checkbox"/> The buzzer beeps <input type="checkbox"/> The Sleep indicator lights up

Power Management

Power Saving Mode	Phenomenon
Hibernation Mode Enter Hibernation Mode (suspend to HDD) when 1.Hibernation hot-key is pressed and system is ready to enter Hibernation mode 2.System Hibernation timer expires and system is ready to enter Hibernation mode.	<input type="checkbox"/> All power shuts off
Display Standby Mode Keyboard, built-in touchpad, and an external PS/2 pointing device are idle for a specified period.	<input type="checkbox"/> The display shuts off
Hard Disk Standby Mode Hard disk is idle within a specified period of time.	<input type="checkbox"/> Hard disk drive is in standby mode. (spindle turned-off)

Environmental Requirements

Item	Specification
Temperature	
Operating	+5~+35 °C
Non-operating	-10~+60 °C
Package storage	-20~+60 °C
Humidity	
Operating	20% to 85% RH, non-condensing
Non-operating	20% to 80% RH, non-condensing (Unpacked)
Non-operating	20% to 90% RH, non-condensing (Storage package)
Vibration	
Operating (unpacked)	5~25.6Hz: 0.38mm (peak to peak) 25.6~250Hz: 0.5G
Non-operating (unpacked)	5~27.1Hz: 0.6G 27.1~50Hz: 0.04mm (peak to peak) 50~500Hz: 2.0G
Non-operating (packed)	5~62.6Hz: 0.51mm (peak to peak) 62.6~500Hz: 4.0G

Mechanical Specification

Item	Specification
Dimensions	322(W) x 294(D) x 39.4~39.9(H)mm
Weight	7.2 lbs for 14.1" TFT LCD model with battery/7.4 lbs for 15"LCD model with battery
I/O Ports	Two type II PCMCIA (PC Card) port, one RJ-11 port, one RJ-45 port, one DC-in port, one ECP parallel port, four USB ports, one microphone-in/line-in jack, one line-out (share with SP-DIF) jack, one VGA port, one FIR port.
Drive Bays	One
Material	Plastic
Indicators	Power-on, Standby, Battery Status, Media Access, CapsLock and NumLock
Switch	Power

System Utilities

BIOS Setup Utility

The BIOS Setup Utility is a hardware configuration program built into your computer's BIOS (Basic Input/Output System).

Your computer is already properly configured and optimized, and you do not need to run this utility. However, if you encounter configuration problems, you may need to run Setup. Please also refer to Chapter 4 Troubleshooting when problem arises.

To activate the BIOS Utility, press **F2** during POST (when "Press <F2> to enter Setup" message is prompted on the bottom of screen).

Press **F2** to enter setup. The default parameter of F12 Boot Menu is set to "disabled". If you want to change boot device without entering BIOS Setup Utility, please set the parameter to "enabled".

Press <F12> during POST to enter multi-boot menu. In this menu, user can change boot device without entering BIOS SETUP Utility.

NOTE: The system information is subject to different models.

PhoenixBIOS Setup Utility					
Information	Main	Advanced	Security	Boot	Exit
CPU Type	Intel® Pentium® 4				
CPU Speed	2.8 GHz				
Floppy Drive:	Not installed				
HDD Model Name:	Toshiba MK3021GAS-(PM)				
HDD Serial Number:	Y3KJ2066TK				
ATAPI Model Name:	QSI CD-RW/DVD-ROM SBW242B-(SM)				
ATAPI Serial Number:	None				
System BIOS Version:	V0.18				
VGA BIOS Version:	008.0171.013.000				
KBC Version:	2.13.29				
Serial Number:	xxxxxxxxxxxxxxxxxxxxxx				
Asset Tag Number:	N/A				
Product Name:	TravelMate 2000	Displays product model names			
Manufacturer Name:	Acer				
UUID:	00000000-0000-0000-0000-00000000				
F1	Help	↑↓	Select Item	F5/F6	Change Values
F9	Setup defaults				
Esc	Exit	←→	Select Menu	Enter	Select Sub-Menu
F10	Save and Exit				

Navigating the BIOS Utility

There are six menu options: Info., Main, System Devices, Security, Boot, and Exit.

Follow these instructions:

- To choose a menu, use the cursor left/right keys (← →).
- To choose a parameter, use the cursor up/down keys (↑ ↓).
- To change the value of a parameter, press F5 or F6.
- A plus sign (+) indicates the item has sub-items. Press ENTER to expand this item.
- Press ESC while you are in any of the menu options to go to the Exit menu.
- In any menu, you can load default settings by pressing F9. You can also press F10 to save any changes made and exit the BIOS Setup Utility.

NOTE: You can change the value of a parameter if it is enclosed in square brackets. Navigation keys for a particular menu are shown on the bottom of the screen. Help for parameters are found in the Item Specific Help part of the screen. Read this carefully when making changes to parameter values.

This menu provides you the information of the system.

Information

PhoenixBIOS Setup Utility	
Information	Main Advanced Security Boot Exit
CPU Type	Intel® Pentium® 4
CPU Speed	2.8 GHz
Floppy Drive:	Not installed
HDD Model Name:	Toshiba MK3021GAS-(PM)
HDD Serial Number:	Y3KJ2066TK
ATAPI Model Name:	QSI CD-RW/DVD-ROM SBW242B-(SM)
ATAPI Serial Number:	None
System BIOS Version:	V0.18
VGA BIOS Version:	008.0171.013.000
KBC Version:	2.13.29
Serial Number:	xxxxxxxxxxxxxxxxxxxx
Asset Tag Number:	N/A
Product Name:	TravelMate 2000 Displays product model names
Manufacturer Name:	Acer
UUID:	00000000-0000-0000-0000-00000000
F1 Help ↕ Select Item F5/F6 Change Values F9 Setup defaults Esc Exit ← Select Menu Enter Select ▸ Sub-Menu F10 Save and Exit	

NOTE: The system information is subject to different models.

Parameter	Description
Floppy Disk Drive	Shows floppy drive type information. Note: Aspre 1620, Extensa 2700, TravelMate 2500 and Extensa 2500 series products do not have floppy disk drive; Extensa 2000 and TravelMate 2000 series have floppy disk drive.
HDD Model Name	This field shows the model name of HDD installed on primary IDE master.
HDD Serial Number	This field displays the serial number of HDD installed on primary IDE master.
ATAPI Model Name	This field displays the model name of devices installed on secondary IDE master. The hard disk drive or optical drive model name is automatically detected by the system.
ATAPI Serial Number	This field shows the serial number of devices installed on secondary IDE master.
Serial Number	This field displays the serial number of this unit.
UUID Number	This will be visible only when an internal LAN device is presenting. UUID=32bytes

Main

The Main screen displays a summary of your computer hardware information, and also includes basic setup parameters. It allows the user to specify standard IBM PC AT system parameters.

PhoenixBIOS Setup Utility		
Information	Main	Advanced Security Boot Exit
Item specific Help		
System Time:	[22:58:45]	
System Date:	[03/18/2004]	<Tab>, <Shift-Tab>, or <Enter> selects field.
System Memory:	640 KB	Show System Memory Size
Extended Memory:	190 MB	Show Extended Memory Size
VGA Memory:	64 MB	Video Memory Size
Quiet Boot:	[Enabled]	
Power on display:	[Auto]	
LCD Auto Dim:	[Enabled]	
PXE Boot From LAN:	[Enabled]	
F12 Boot Menu:	[Disabled]	
F1 Help	↑↓ Select Item	F5/F6 Change Values F9 Setup defaults
Esc Exit	←→ Select Menu	Enter Select ▸ Sub-Menu F10 Save and Exit

NOTE: The screen above is for reference only. Actual values may differ.

The table below describes the parameters in this screen. Settings in **boldface** are the default and suggested parameter settings.

Parameter	Description	Format/Option
System Time	Sets the system time. The hours are displayed with 24-hour format.	Format: HH:MM:SS (hour:minute:second) System Time
System Date	Sets the system date.	Format MM/DD/YYYY (month/day/year) System Date
System Memory	This field reports the memory size of the system. Memory size is fixed to 640MB	
Extended Memory	This field reports the memory size of the extended memory in the system. Extended Memory size=Total memory size-1MB	
VGA Memory	Shows the VGA memory size. VGA Memory size=64/128MB	
Fast Boot	Determines if Customer Logo will be displayed or not; shows Summary Screen is disabled or enabled. Enabled: Customer Logo is displayed, and Summary Screen is disabled. Disabled: Customer Logo is not displayed, and Summary Screen is enabled.	Option: Enabled or Disabled
Power on display	Auto: During power process, the system will detect if any display device is connected on external video port. If any external display device is connected, the power on display will be in CRT (or projector) only mode. Otherwise it will be in LCD only mode. Both: Simultaneously enable both the integrated LCD screen and the system's external video port (for an external CRT or projector).	Option: Auto or Both
LCD Auto Dim	Determines if the system will automatically dim the LCD brightness in order to save power when AC is not present. The system will support an automatic dimming of the LCD backlight when the AC power is NOT available (running on battery power).	Option: Enabled or Disabled
PXE Boot from LAN	Enables, disables the system boot from LAN (remote server). PXE is the protocol.	Option: Enabled or Disabled
F12 Boot Menu	Enables, disables Boot Menu during POST.	Option: Disabled or Enabled

NOTE: The sub-items under each device will not be shown if the device control is set to disable or auto. This is because the user is not allowed to control the settings in these cases.

NOTE: If user disables "PXE Boot from LAN" option in BIOS Setup Utility, this item will be disappeared.

Advanced

The Advanced menu screen contains parameters involving your hardware devices. It also provides advanced settings of the system.

PhoenixBIOS Setup Utility		
Information	Main	Advanced
		Security
		Boot
		Exit
		Item specific Help
Hyper-Threading Technology	[Enabled]	
Infrared Port (FIR):	[Disabled]	Configure Infrared Port using options:
Parallel Port:	[Enabled]	
Mode:	[ECP]	[Disabled]
Base I/O address:	[378]	No configuration
Interrupt::	[IRQ 7]	[Enabled]
DMA channel:	[DMA 1]	User configuration
Legacy USB Support:	[Disabled]	
▶ Event Logging		[Auto]
		BIOS or OS chooses configuration
		(OS Controlled)
		Displayed when controlled by OS
F1	Help	↑↓ Select Item
		F5/F6 Change Values
		F9 Setup defaults
Esc	Exit	←→ Select Menu
		Enter Select ▶ Sub-Menu
		F10 Save and Exit

The table below describes the parameters in the screen. Settings in **boldface** are the default and suggested parameter settings.

Parameter	Description	Options
Hyper-Threading Technology	The function is supported only when the CPU installed is 3.06G or above. The system will automatically hide this selection when detecting the CPU frequency is below 3.06G or the CPU does not support Hyper-Threading Technology.	Enabled /Disabled
Infrared Port	Enables, disables or auto detects the infrared port.	Disabled /Disabled/Auto
Parallel Port	Enables, disables or auto detects the parallel port.	Enabled /Disabled/Auto
Mode	Sets the operation mode of the parallel port.	ECP , EPP, Output only or Bi-directional
Base I/O address	Sets the I/O address of the parallel port.	378 /278
Interrupt	Sets the interrupt request of the parallel port.	IRQ7 /IRQ5
DMA channel	Sets a DMA channel for the printer to operate in ECP mode. This parameter is enabled only if Mode is set to ECP.	DMA3 /DMA1

Parameter	Description	Options
Legacy USB Support	Enables, disables USB interface devices support under DOS mode.	Option: Disabled or Enabled

Security

The Security screen contains parameters that help safeguard and protect your computer from unauthorized use.

PhoenixBIOS Setup Utility					
Information	Main	Advanced	Security	Boot	Exit
				Item specific Help	
User Password Is		Clear			
Supervisor Password Is		Clear		Supervisor Password controls access to the setup utility.	
Set User Password		[Enter]			
Set Supervisor Password		[Enter]			
Primary HardDisk Security:		[Disabled]			
Password on Boot:		[Disabled]			
F1	Help	↑↓	Select Item	F5/F6	Change Values
F9	Setup defaults				
Esc	Exit	←→	Select Menu	Enter	Select ▸ Sub-Menu
F10	Save and Exit				

The table below describes the parameters in this screen. Settings in **boldface** are the default and suggested parameter settings.

Parameter	Description	Option
User Password is	Shows the setting of the user password.	Clear or Set
Supervisor Password is	Shows the setting of the Supervisor password	Clear or Set
Set User Password	Press Enter to set the user password. When set, this password protects the BIOS Setup Utility from unauthorized access.	
Set Supervisor Password	Press Enter to set the supervisor password. When set, this password protects the BIOS Setup Utility from unauthorized access.	
Primary Harddisk Security	This feature is available to user when Supervisor password is set. Password can be written on HDD only when Supervisor password or user password is set and password on HDD is set to enabled. Supervisor Password is written to HDD only when Supervisor password is being set. User password is written to HDD when both passwords are set. When both Supervisor and user password are present, both passwords can unlock the HDD.	Disabled or Enabled
Password on Boot	Defines whether a password is required or not while the events defined in this group happened. The following sub-options are all requires the Supervisor password for changes and should be grayed out if the user password was used to enter setup.	Disabled or Enabled

NOTE: When you are prompted to enter a password, you have three tries before the system halts. Don't forget your password. If you forget your password, you may have to return your notebook computer to your dealer to reset it.

Setting a Password

Follow these steps as you set the user or the supervisor password:

1. Use the **↑** and **↓** keys to highlight the Set Supervisor Password parameter and press the **ENTER** key. The Set Supervisor Password box appears:

Set Supervisor Password

Enter New Password []

Confirm New Password []

2. Type a password in the "Enter New Password" field. The password length can not exceeds 8 alphanumeric characters (A-Z, a-z, 0-9, not case sensitive). Retype the password in the "Confirm New Password" field.

IMPORTANT: Be very careful when typing your password because the characters do not appear on the screen.

3. Press **ENTER**.
4. After setting the password, the computer sets the User Password parameter to "Set".
4. If desired, you can opt to enable the Password on boot parameter.
5. When you are done, press **F10** to save the changes and exit the BIOS Setup Utility.

Removing a Password

Follow these steps:

1. Use the **↑** and **↓** keys to highlight the Set Supervisor Password parameter and press the **ENTER** key. The Set Password box appears:

Set Supervisor Password

Enter current password []

Enter New Password []

Confirm New Password []

2. Type the current password in the Enter Current Password field and press **ENTER**.
3. Press **ENTER** twice **without** typing anything in the Enter New Password and Confirm New Password fields. The computer then sets the Supervisor Password parameter to “Clear”.
4. When you have changed the settings, press **F10** to save the changes and exit the BIOS Setup Utility.

Changing a Password

1. Use the **↑** and **↓** keys to highlight the Set Supervisor Password parameter and press the **ENTER** key. The Set Password box appears:

Set Supervisor Password

Enter current password []

Enter New Password []

Confirm New Password []

2. Type the current password in the Enter Current Password field and press **ENTER**.
3. Type a password in the Enter New Password field. Retype the password in the Confirm New Password field.
4. Press **ENTER**. After setting the password, the computer sets the User Password parameter to “Set”.
5. If desired, you can enable the Password on boot parameter.
6. When you are done, press **F10** to save the changes and exit the BIOS Setup Utility.

If the verification is OK, the screen will display as following.

Setup Notice

Changes have been saved.

[continue]

The password setting is complete after the user presses **F10**.

If the current password entered does not match the actual current password, the screen will show you the Setup Warning.

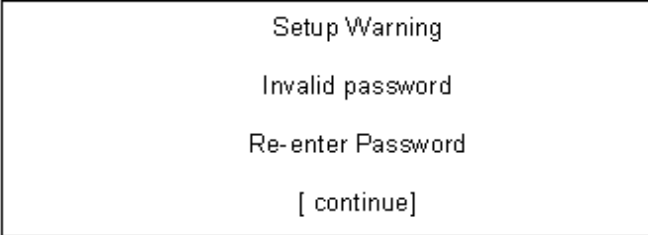

Setup Warning
Invalid password
Re-enter Password
[continue]

A rectangular dialog box with a black border containing four lines of text centered horizontally.

If the new password and confirm new password strings do not match, the screen will display the following message.

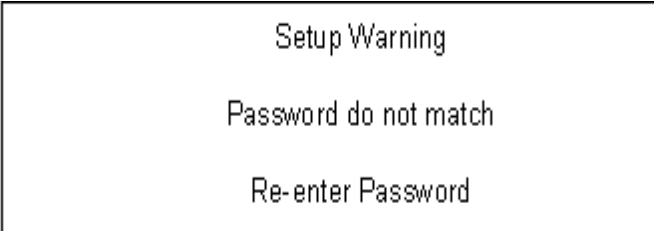

Setup Warning
Password do not match
Re-enter Password

A rectangular dialog box with a black border containing three lines of text centered horizontally.

Boot

This menu allows the user to decide the order of boot devices to load the operating system. Bootable devices includes the distette drive in module bay, the onboard hard disk drive and the CD-ROM in module bay.

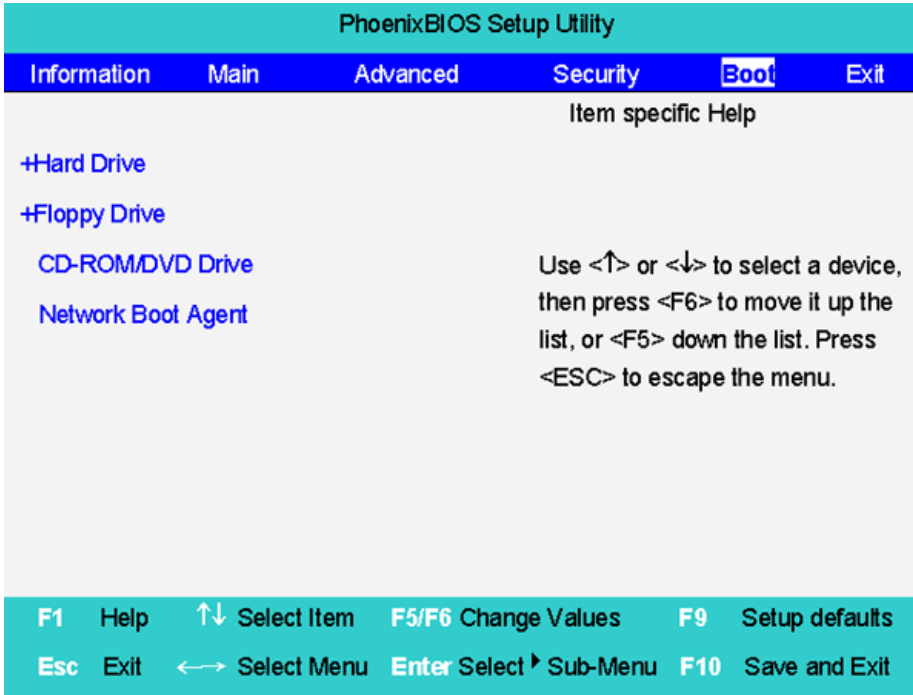

Exit

The Exit screen contains parameters that help safeguard and protect your computer from unauthorized use.

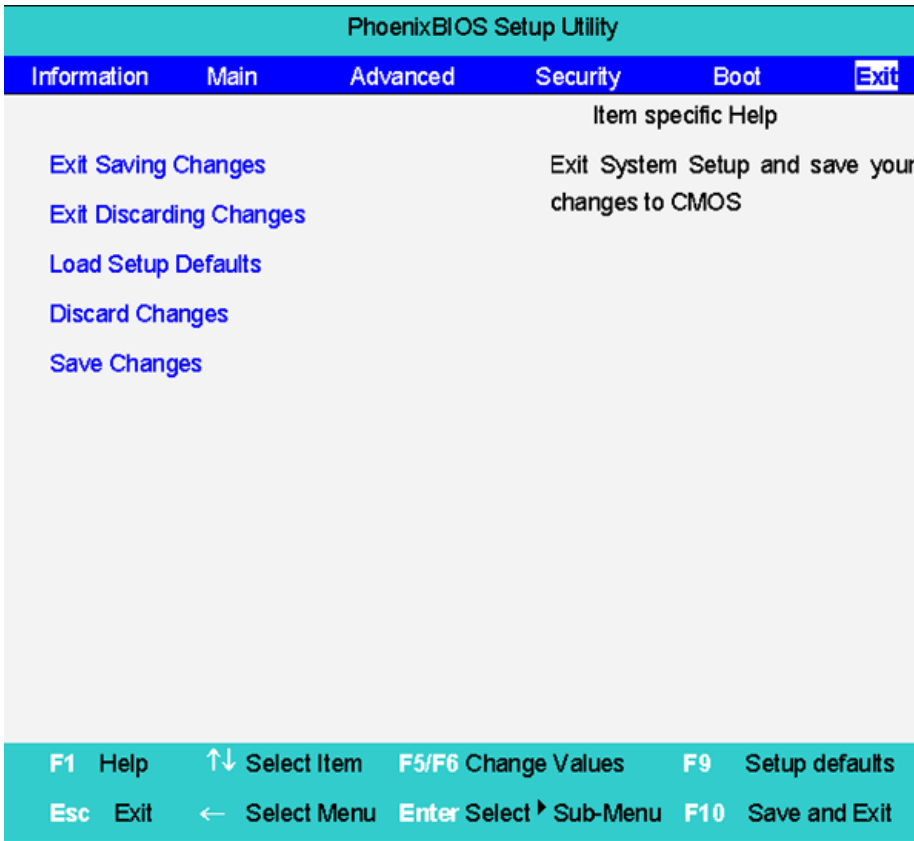

The table below describes the parameters in this screen.

Parameter	Description
Exit Saving Changes	Exit System Setup and save your changes to CMOS.
Exit Discarding Changes	Exit utility without saving setup data to CMOS.
Load Setup Default	Load default values for all SETUP item.
Discard Changes	Load previous values from CMOS for all SETUP items.
Save Changes	Save Setup Data to CMOS.

BIOS Flash Utility

The BIOS flash memory update is required for the following conditions:

- New versions of system programs
- New features or options
- Restore a BIOS when it becomes corrupted.

Use the Phlash utility to update the system BIOS flash ROM.

NOTE: If you do not have a crisis recovery diskette at hand, then you should create a **Crisis Recovery Diskette** before you use the Phlash utility.

NOTE: Do not install memory-related drivers (XMS, EMS, DPMS) when you use the Phlash.

NOTE: Please use the AC adaptor power supply when you run the Phlash utility. If the battery pack does not contain enough power to finish BIOS flash, you may not boot the system because the BIOS is not completely loaded.

Follow the steps below to run the Phlash.

1. Prepare a bootable diskette.
2. Copy the Phlash utilities to the bootable diskette.
3. Then boot the system from the bootable diskette. The Phlash utility has auto-execution function.

Machine Disassembly and Replacement

This chapter contains step-by-step procedures on how to disassemble the notebook computer for maintenance and troubleshooting.

To disassemble the computer, you need the following tools:

- Wrist grounding strap and conductive mat for preventing electrostatic discharge
- Flat-bladed screw driver
- Phillips screw driver
- Tweezers
- Plastic Flat-bladed screw driver
- Hexed Screw Driver

NOTE: The screws for the different components vary in size. During the disassembly process, group the screws with the corresponding components to avoid mismatch when putting back the components.

NOTE: This chapter has been revised from previous model (TravelMate 240/250). Please refer to the disassembling *procedures* instead of the *images*. Some of the images below contain the parts used in TravelMate 240/250, but not in Extensa 2000/2500.

General Information

Before You Begin

Before proceeding with the disassembly procedure, make sure that you do the following:

1. Turn off the power to the system and all peripherals.
2. Unplug the AC adapter and all power and signal cables from the system.

Disassembly Procedure Flowchart

The flowchart on the succeeding page gives you a graphic representation on the entire disassembly sequence and instructs you on the components that need to be removed during servicing. For example, if you want to remove the main board, you must first remove the keyboard, then disassemble the inside assembly frame in that order.

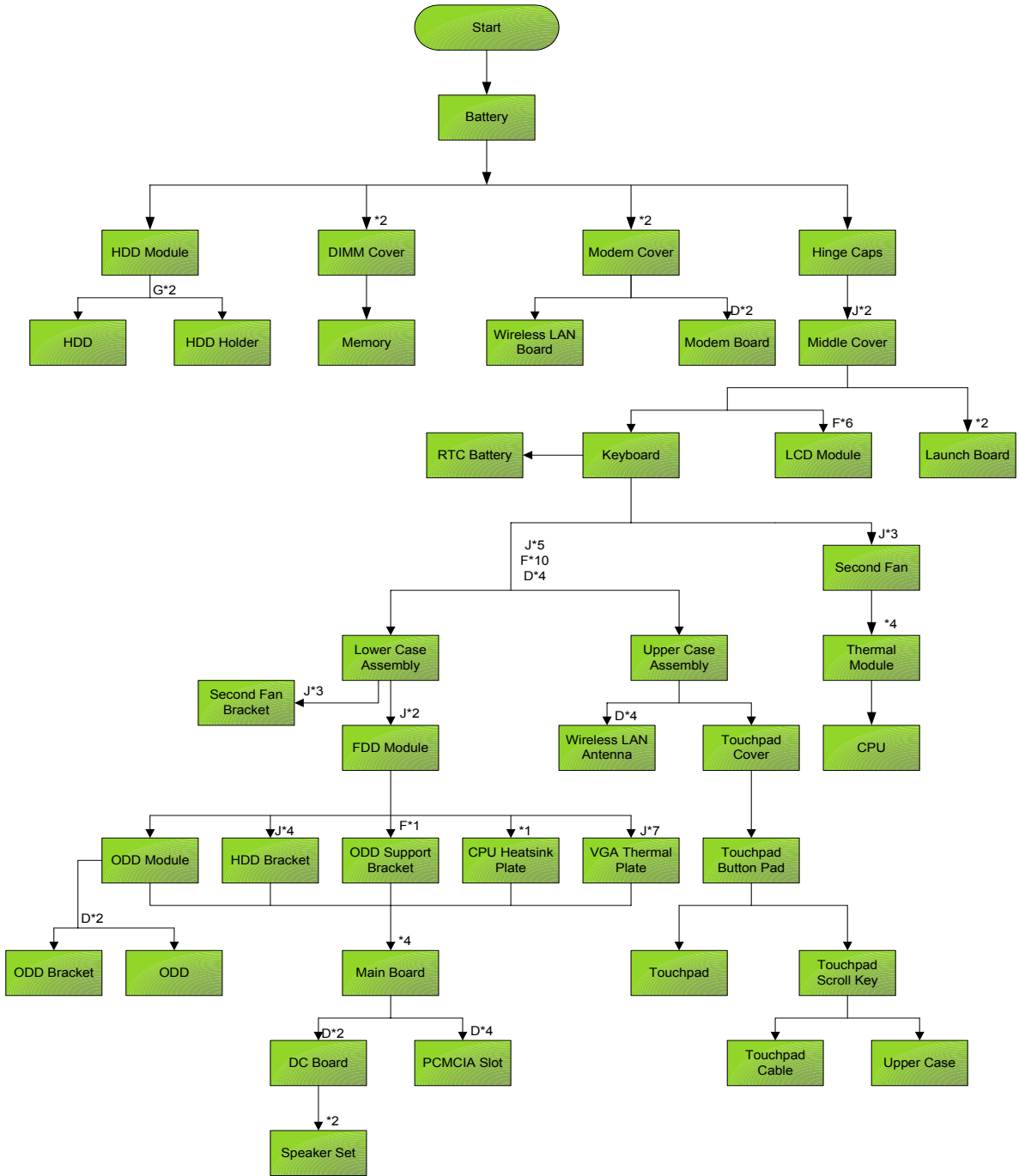

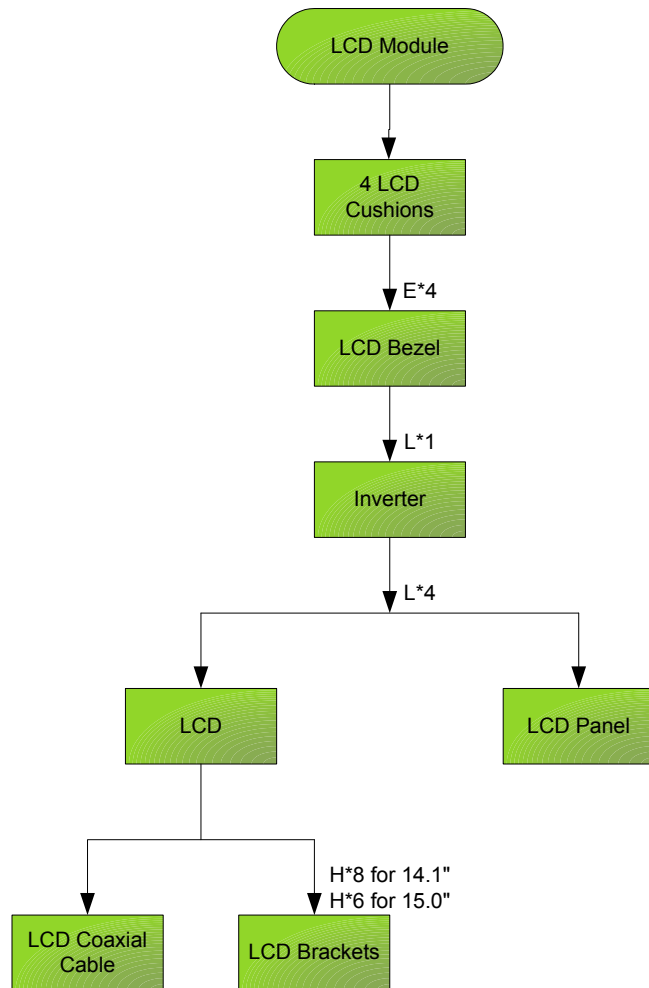

Screw List

Item	Description
A	SCW HEX NYL I#R-40/O#4-40 L5.5(34.00015.081)
B	SCRW MACH PAN NYLOK M2.0*10 NI (86.1A522.100)
C	SCRW CPU SCREW FORCE 5KGS(86.T30V1.001)
D	SCREW M2*3 NYLON 1JMCPC-420325(86.9A352.3R0)
E	SCREW M2.5X6(86.9A353.6R0)
F	SRW M2.5*8L B/ZN NYLOK 700(86.9A353.8R0)
G	SCREW M3x4(86.9A524.4R0)
H	SCREW M2X2.0(86.9A552.2R0)
I	SCREW WAFER NYLOK NI 2ML3(86.9A552.3R0)
J	SCRW M2*4 WAFER NI(86.9A552.4R0)
K	SCRW M2.5*3 WAFER NI(86.9A553.3R0)
L	SCREW M2.5*4L NI(86.9A553.4R0)

Removing the Battery

1. To remove the battery, push the battery release latch.
2. Then slide the battery out from the machine.



Removing the Memory Module

1. See “Removing the Battery” on page 50.
2. To remove the memory module from the machine, first remove the two screws holding the dimm cover.



3. Remove the dimm cover.



4. Pop up the memory.
5. Then remove the memory.



Removing the Wireless LAN Board and the Modem Board

1. See “Removing the Battery” on page 50.
2. To remove the wireless LAN board, first remove the two screws holding the modem cover.



3. Remove the modem cover from the machine.
4. Disconnect the wireless antennae.



5. Pop out the wireless LAN board.
6. To remove the modem board, first remove the two screws fastening the modem board.



7. Detach the modem board and disconnect the modem cable carefully, then remove the modem board.



Removing the Hard Disk Drive Module

1. See “Removing the Battery” on page 50.
2. To remove the hard disk drive, pull the hard disk drive carefully.



3. Then take the hard disk drive out of the main unit.

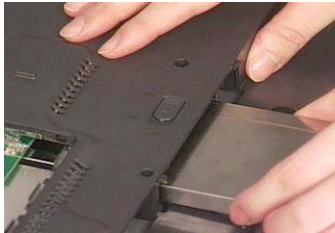

Disassembling the Hard Disk Drive Module

1. See “Removing the Battery” on page 50.
2. See “Removing the LCD Module” on page 54.
3. Remove the two screws that fasten the HDD holder.

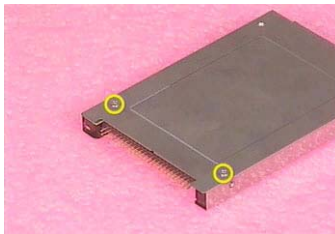

4. Detach the hard disk drive from the HDD holder.



Removing the LCD Module

Removing the Middle Cover

1. See “Removing the Battery” on page 50.
2. To remove the middle cover, first use a plastic flat screwdriver to remove the right hinge cap.
3. Remove the screw that secures the middle cover.



4. Remove the left hinge cap.
5. Then remove the screw holding the middle cover on the other side.



6. Detach the middle cover from the machine.



7. Disconnect the launch board cable then remove the middle cover off the main unit.

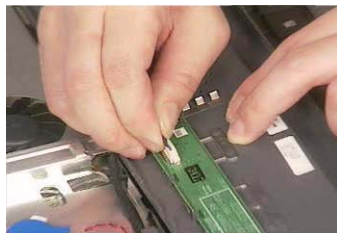

Removing the Launch Board

1. See “Removing the Battery” on page 50.
2. See “Removing the Middle Cover” on page 54.

3. Remove the two screws and then detach the launch board from the middle cover.

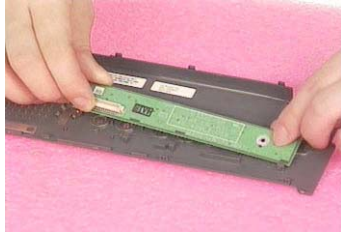

Removing the LCD Module

1. See “Removing the Battery” on page 50.
2. See “Removing the Middle Cover” on page 54.
3. See “Removing the Launch Board” on page 54.
4. Remove the screw that fastens the LCD coaxial cable and disconnect the cable. Then disconnect the LCD inverter cable.



5. Remove the four screws holding the LCD hinge; two on the right and two on the left. Remove the four screws holding the LCD hinge; two on the right and two on the left.



6. Remove the two screws on the bottom; one on the right and the other on the left.



7. Then you can remove the entire LCD module from the main unit.

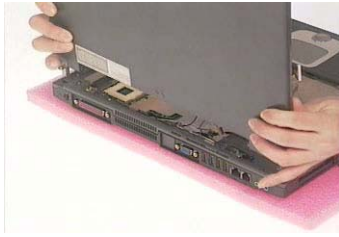

Disassembling the LCD Module

Removing the LCD Bezel

1. See “Removing the Battery” on page 50.
2. See “Removing the Middle Cover” on page 54.
3. See “Removing the Launch Board” on page 54.
4. See “Removing the LCD Module” on page 55.
5. Use plastic tweezers to remove the four screw pads, and then remove the four screws that fasten the LCD bezel.

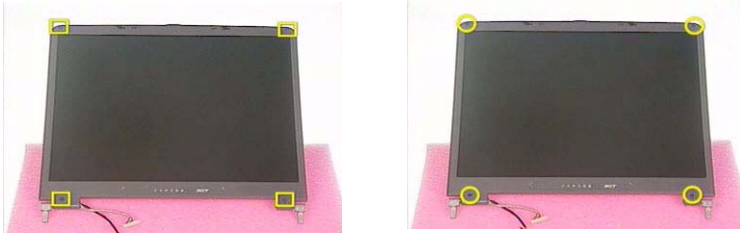

6. Snap off the bezel carefully, and then remove the LCD bezel from the LCD module.



Removing the Inverter Board (15" LCD)

1. See “Removing the Battery” on page 50.
2. See “Removing the Middle Cover” on page 54.
3. See “Removing the Launch Board” on page 54.
4. See “Removing the LCD Module” on page 55.
5. See “Removing the LCD Bezel” on page 57.
6. To remove the inverter board, first remove one screw from the inverter board.

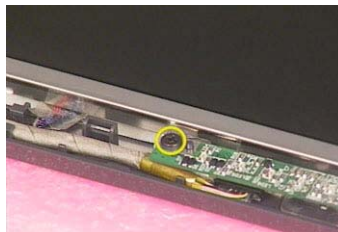

7. Disconnect the LCD power cable then disconnect the inverter cable from the inverter board.



NOTE: Please arrange the LCD inverter cable well to the LCD panel as the picture below shows when you reassemble the LCD module.

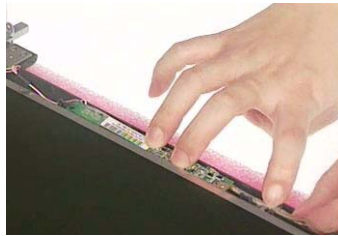

Removing the 15" TFT LCD

1. See "Removing the Battery" on page 50.
2. See "Removing the Middle Cover" on page 54.
3. See "Removing the Launch Board" on page 54.
4. See "Removing the LCD Module" on page 55.
5. See "Removing the LCD Bezel" on page 57.
6. See "Removing the Inverter Board (15" LCD)" on page 57.
7. To remove the LCD, first remove the four screws that secure the LCD hinges.



8. Then take the LCD out of the LCD panel.



Removing the LCD Brackets

1. See "Removing the Battery" on page 50.

2. See “Removing the Middle Cover” on page 54.
3. See “Removing the Launch Board” on page 54.
4. See “Removing the LCD Module” on page 55.
5. See “Removing the LCD Bezel” on page 57.
6. See “Removing the Inverter Board (15” LCD)” on page 57.
7. See “Removing the 15” TFT LCD” on page 58.
8. Remove the four screws holding the right LCD bracket. Then remove the right bracket.

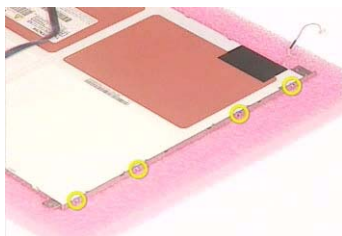

9. Remove the four screws holding the left LCD bracket. Then remove the left bracket..

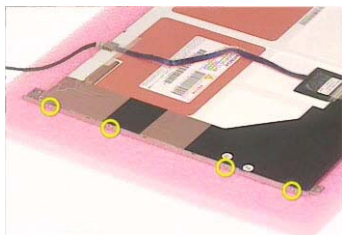

Removing the LCD Coaxial Cable

1. See “Removing the Battery” on page 50.
2. See “Removing the Middle Cover” on page 54.
3. See “Removing the Launch Board” on page 54.
4. See “Removing the LCD Module” on page 55.
5. See “Removing the LCD Bezel” on page 57.
6. See “Removing the Inverter Board (15” LCD)” on page 57.
7. See “Removing the 15” TFT LCD” on page 58.
8. Tear off the mylar fastening the LCD coaxial cable, then disconnect the coaxial cable.



Removing the LCD Hinges

1. See “Removing the Battery” on page 50.

-
2. See “Removing the Middle Cover” on page 54.
 3. See “Removing the Launch Board” on page 54.
 4. See “Removing the LCD Module” on page 55.
 5. See “Removing the LCD Bezel” on page 57.
 6. See “Removing the Inverter Board (15” LCD)” on page 57.
 7. See “Removing the 15” TFT LCD” on page 58.
 8. Remove the screw holding the right hinge, then remove the right hinge.

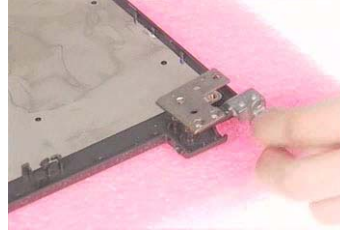

9. Remove the screw holding the left hinge, then remove the left hinge.



Disassembling the Main Unit

Removing the Keyboard

1. See “Removing the Battery” on page 50.
2. See “Removing the Middle Cover” on page 54.
3. To remove the keyboard, carefully pull the keyboard out and upwards as the picture shows.



4. Use a plastic tweezers or a plastic flat screwdriver to disconnect the keyboard cable from the main board carefully, then remove the keyboard.

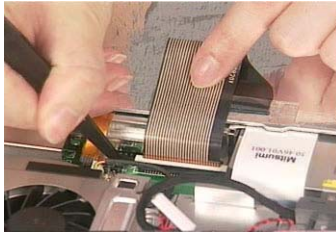

Removing the RTC Battery

1. See “Removing the Battery” on page 50.
2. See “Removing the Middle Cover” on page 54.
3. See “Removing the Keyboard” on page 61.
4. Disconnect the RTC battery cable then remove it.



Removing the Fan

1. See “Removing the Battery” on page 50.
2. See “Removing the Middle Cover” on page 54.
3. See “Removing the Keyboard” on page 61.
4. Disconnect the fan cable and remove the three screws fastening the fan. Then remove the fan.

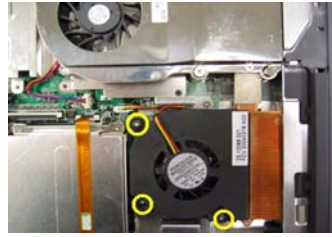
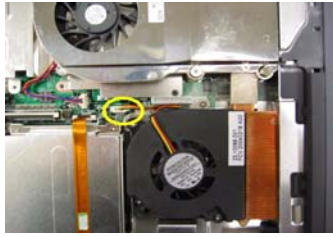

Removing the Thermal Module

1. See “Removing the Battery” on page 50.
2. See “Removing the Middle Cover” on page 54.
3. See “Removing the Keyboard” on page 61.
4. See “Removing the Fan” on page 61.
5. Disconnect the fan cable then remove the four screws fastening the thermal module.

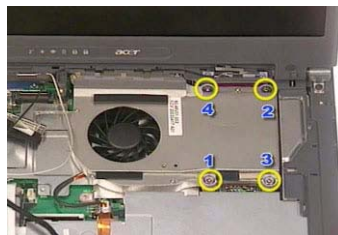
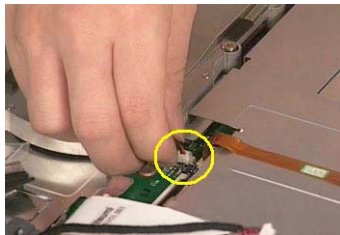

6. Then remove the thermal module.

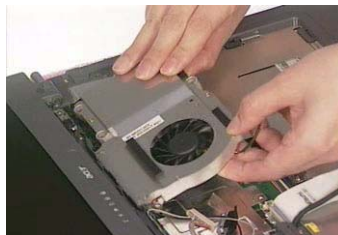

Removing the Processor

1. See “Removing the Battery” on page 50.
2. See “Removing the Middle Cover” on page 54.
3. See “Removing the Keyboard” on page 61.
4. See “Removing the RTC Battery” on page 61.
5. See “Removing the Fan” on page 61.
6. See “Removing the Thermal Module” on page 62.
7. Lift up the CPU socket lever. Then remove the CPU. Remember to press down the lever as the video shows after you remove the CPU.

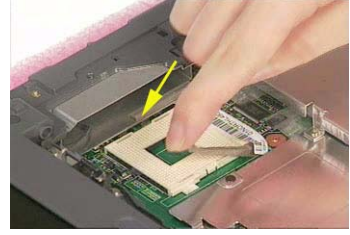
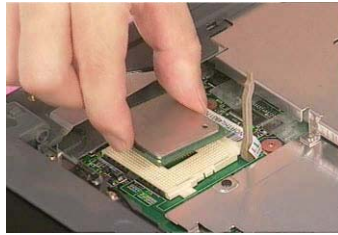
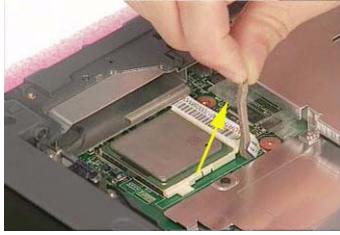

Installing the Processor

1. See “Removing the Battery” on page 50.
2. See “Removing the Middle Cover” on page 54.
3. See “Removing the Keyboard” on page 61.
4. See “Removing the RTC Battery” on page 61.
5. See “Removing the Fan” on page 61.
6. See “Removing the Thermal Module” on page 62.
7. Lift up the CPU lever, then place the CPU back to the CPU socket. Please remember to press the CPU lever after you put the CPU back to the socket.

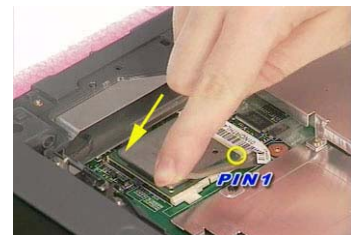
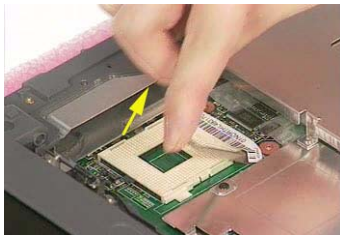

Removing the Upper Case Assembly

1. See “Removing the Keyboard” on page 61.
2. Disconnect the touchpad cable.

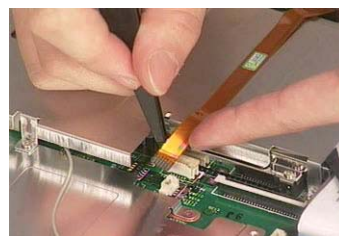
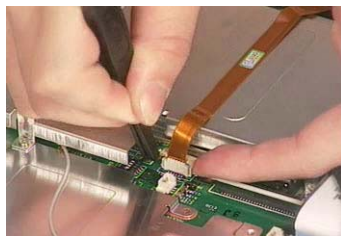

3. Remove the 6 screws that secure the upper case to the lower case. Then turn over the main unit and remove the 15 screws holding the lower case to the upper case.

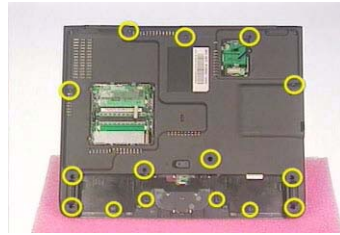
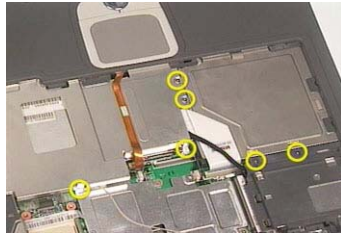

4. Then take the upper case assembly off the main unit.



Removing the Touchpad Board

1. See “Removing the Battery” on page 50.
2. See “Removing the Middle Cover” on page 54.
3. See “Removing the Keyboard” on page 61.
4. See “Removing the Upper Case Assembly” on page 63.
5. To detach the touch pad board, first disconnect the touch pad cable from the touch pad board with a plastic tweezers. Then release the touchpad cover lock on the back as the picture shows.

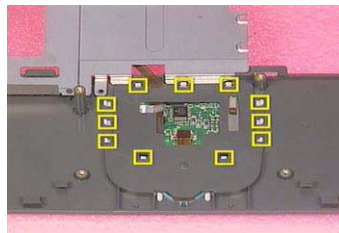

6. Remove the touchpad cover, then remove the touchpad button pad. Finally remove the touchpad board from the upper case.



Removing the Touchpad Cable

1. See “Removing the Battery” on page 50.
2. See “Removing the Middle Cover” on page 54.

3. See “Removing the LCD Module” on page 55.
4. See “Removing the Keyboard” on page 61.
5. See “Removing the Upper Case Assembly” on page 63.
6. See “Removing the Touchpad Board” on page 64.
7. Remove the touchpad scroll key then remove the touchpad cable.

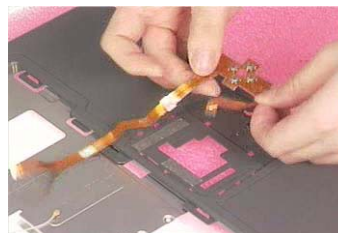

Removing the Floppy Disk Drive Module

NOTE: This portion is prepared for the models with floppy disk drive. If you get the machine without floppy disk drive module, please skip this part.

1. See “Removing the Middle Cover” on page 54.
2. See “Removing the LCD Module” on page 55.
3. See “Removing the Keyboard” on page 61.
4. See “Removing the Upper Case Assembly” on page 63.
5. Disconnect the FDD cable from the main board.

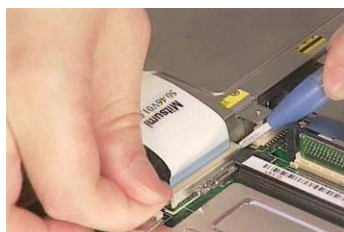

6. Remove the two screws hastening the FDD module. Detach the FDD module from the lower case.

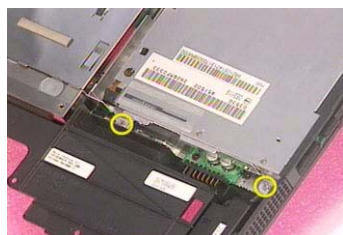

Disassembling the Floppy Disk Drive Module

1. Disconnect the FDD cable.
2. Remove the two screws that fasten the FDD bracket on one side.

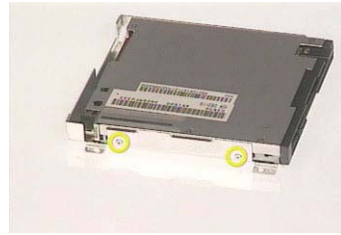
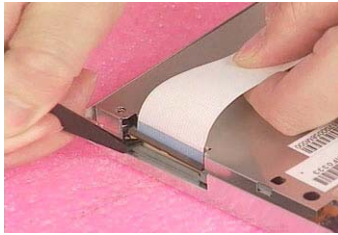

3. Remove another two screws holding the FDD bracket on the other side. Then take the FDD off the FDD bracket.

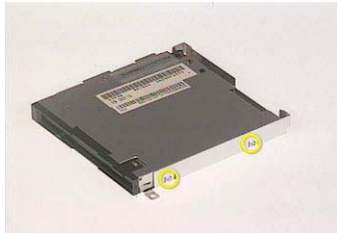

Removing the VGA Thermal Plate

1. See “Removing the Battery” on page 50.
2. See “Removing the Middle Cover” on page 54.
3. See “Removing the Keyboard” on page 61.
4. See “Removing the Fan” on page 61.
5. See “Removing the Thermal Module” on page 62.
6. Remove the seven screws holding the VGA thermal plate then remove it.

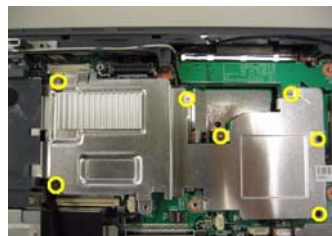

Removing the CPU Heatsink Plate

1. See “Removing the Battery” on page 50.
2. See “Removing the Middle Cover” on page 54.
3. See “Removing the Keyboard” on page 61.
4. See “Removing the Floppy Disk Drive Module” on page 65.
5. Remove the screw that fastens the CPU heatsink plate then remove it.

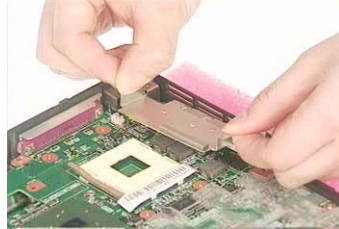

Removing the Second Fan Bracket

1. See “Removing the Battery” on page 50.
2. See “Removing the Middle Cover” on page 54.
3. See “Removing the LCD Module” on page 55.
4. See “Removing the RTC Battery” on page 61.
5. See “Removing the Fan” on page 61.
6. See “Removing the Thermal Module” on page 62.
7. Remove the three screws that fasten the second fan bracket then remove the bracket.



Removing the ODD Module(1)

1. See “Removing the Battery” on page 50.
2. Remove the screw that fastens the ODD bracket on the bottom. Push the ODD module at the point the red arrow indicates hard. Then remove the ODD module from the lower case.



NOTE: If you need to replace the ODD module only, you can remove the ODD module as the steps above.

Removing the ODD Module(2)

1. See “Removing the Battery” on page 50.
2. See “Removing the Middle Cover” on page 54.
3. See “Removing the Keyboard” on page 61.
4. See “Removing the Floppy Disk Drive Module” on page 65.

5. Push the ODD module outwards then take the ODD out of the support bracket. Remove the screw that fastens the ODD support bracket then remove it.

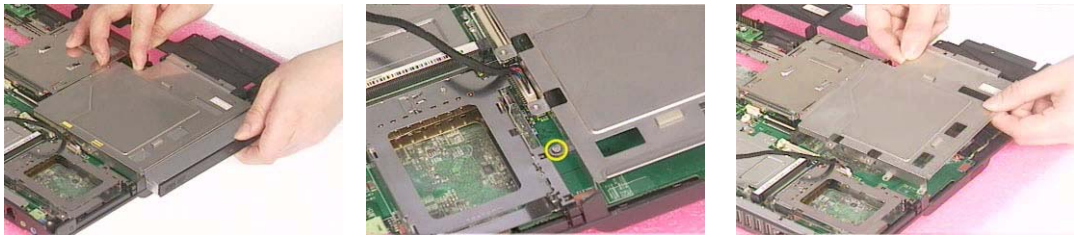

Removing the HDD Bracket

1. See “Removing the Battery” on page 50.
2. See “Removing the Middle Cover” on page 54.
3. See “Removing the Keyboard” on page 61.
4. See “Removing the Upper Case Assembly” on page 63.
5. Remove the four screws holding the HDD bracket, then remove the HDD bracket.

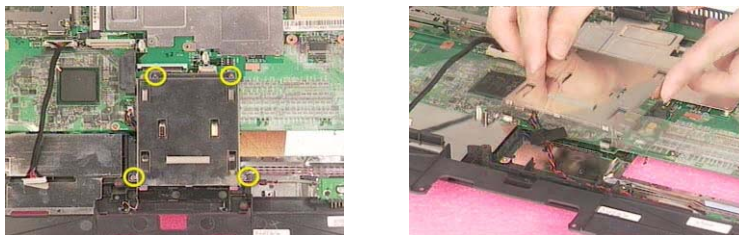

Removing the Main Board

1. See “Removing the Battery” on page 50.
2. See “Removing the Middle Cover” on page 54.
3. See “Removing the Keyboard” on page 61.
4. See “Removing the Fan” on page 61.
5. See “Removing the Thermal Module” on page 62.
6. See “Removing the Upper Case Assembly” on page 63.
7. See “Removing the VGA Thermal Plate” on page 66.
8. See “Removing the CPU Heatsink Plate” on page 66.
9. See “Removing the Floppy Disk Drive Module” on page 65.
10. See “Removing the Second Fan Bracket” on page 67.
11. See “Removing the ODD Module(2)” on page 67.
12. See “Removing the HDD Bracket” on page 68.
13. Disconnect the launch board cable. Tear off the tape that fastens the speaker set cable. Then disconnect the speaker set cable.

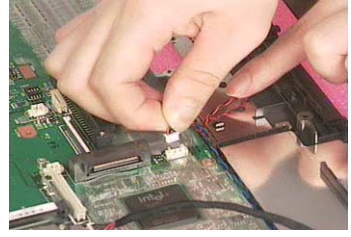
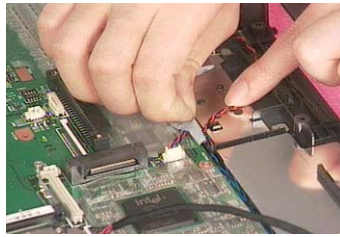
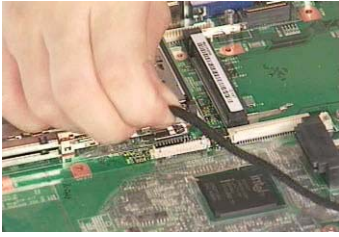

14. Remove the two screws holding the main board as the picture shows. Remove another two screws that fasten the main board. Then detach the main board from the lower case carefully.

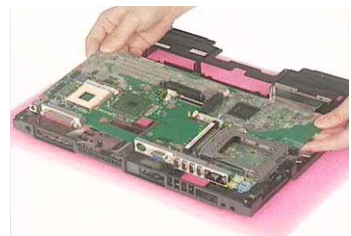
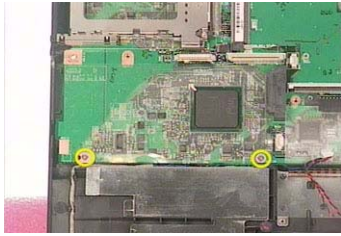

Removing the DC Board

1. See "Removing the Battery" on page 50.
2. See "Removing the Middle Cover" on page 54.
3. See "Removing the Keyboard" on page 61.
4. See "Removing the Fan" on page 61.
5. See "Removing the Thermal Module" on page 62.
6. See "Removing the Upper Case Assembly" on page 63.
7. See "Removing the VGA Thermal Plate" on page 66.
8. See "Removing the CPU Heatsink Plate" on page 66.
9. See "Removing the Floppy Disk Drive Module" on page 65.
10. See "Removing the Second Fan Bracket" on page 67.
11. See "Removing the ODD Module(2)" on page 67.
12. See "Removing the HDD Bracket" on page 68.
13. See "Removing the Main Board" on page 68.
14. Remove the two screws that fasten the DC board. Then detach the DC board from the lower case.

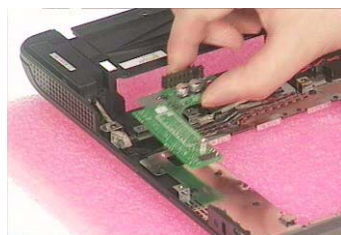

Removing the I/O Port Bracket

1. See "Removing the Battery" on page 50.

-
2. See “Removing the Middle Cover” on page 54.
 3. See “Removing the Keyboard” on page 61.
 4. See “Removing the Fan” on page 61.
 5. See “Removing the Thermal Module” on page 62.
 6. See “Removing the Upper Case Assembly” on page 63.
 7. See “Removing the VGA Thermal Plate” on page 66.
 8. See “Removing the CPU Heatsink Plate” on page 66.
 9. See “Removing the Floppy Disk Drive Module” on page 65.
 10. See “Removing the Second Fan Bracket” on page 67.
 11. See “Removing the ODD Module(2)” on page 67.
 12. See “Removing the HDD Bracket” on page 68.
 13. See “Removing the Main Board” on page 68.
 14. Remove the four hex screws to detach the I/O port bracket from the main board.



Removing the PCMCIA Slot

1. See “Removing the Battery” on page 50.
2. See “Removing the Middle Cover” on page 54.
3. See “Removing the Keyboard” on page 61.
4. See “Removing the Fan” on page 61.
5. See “Removing the Thermal Module” on page 62.
6. See “Removing the Upper Case Assembly” on page 63.
7. See “Removing the VGA Thermal Plate” on page 66.
8. See “Removing the CPU Heatsink Plate” on page 66.
9. See “Removing the Floppy Disk Drive Module” on page 65.
10. See “Removing the Second Fan Bracket” on page 67.
11. See “Removing the ODD Module(2)” on page 67.
12. See “Removing the HDD Bracket” on page 68.
13. See “Removing the Main Board” on page 68.
14. Remove the four screws that secure the PCMCIA slot, then remove the PCMCIA slot from the lower case.

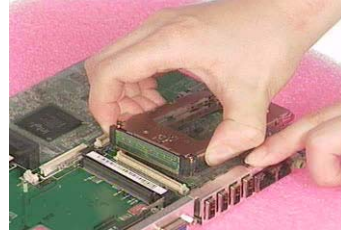
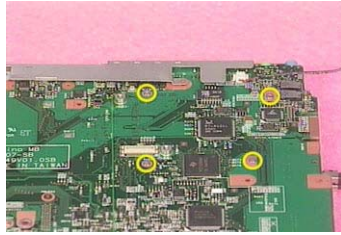

Removing the Speaker Set

1. See “Removing the Battery” on page 50.
2. See “Removing the Middle Cover” on page 54.
3. See “Removing the Keyboard” on page 61.
4. See “Removing the Floppy Disk Drive Module” on page 65.
5. See “Removing the VGA Thermal Plate” on page 66.
6. See “Removing the CPU Heatsink Plate” on page 66.
7. See “Removing the Second Fan Bracket” on page 67.
8. See “Removing the HDD Bracket” on page 68.
9. See “Removing the Main Board” on page 68.
10. See “Removing the DC Board” on page 69.
11. Tear off the tape fastening the speaker set cable. Then remove the four screws that secure the speaker set. Remove the speaker set from the lower case.

System Upgrade Procedure

Base Unit to Wireless Unit

1. Turn out the two screws fastening the modem cover then open the cover.
2. Connect the wireless antennae.
3. Insert the wireless LAN board to the wireless socket on the main board.
4. Close the modem cover and fasten the cover with the two screws.

NOTE: You must connect the wireless antennae before you insert the wireless LAN board to the socket. If you insert the wireless LAN card first, the pressure you press to fasten the wireless antennae may damage the main board.



Troubleshooting

Use the following procedure as a guide for computer problems.

NOTE: The diagnostic tests are intended to test only Acer products. Non-Acer products, prototype cards, or modified options can give false errors and invalid system responses.

1. Obtain the failing symptoms in as much detail as possible.
2. Verify the symptoms by attempting to re-create the failure by running the diagnostic test or by repeating the same operation.
3. Use the following table with the verified symptom to determine which page to go to.

Symptoms (Verified)	Go To
Power failure. (The power indicator does not go on or stay on.)	"Power System Check" on page 76.
POST does not complete. No beep or error codes are indicated.	"Power-On Self-Test (POST) Error Message" on page 79 "Undetermined Problems" on page 91
POST detects an error and displayed messages on screen.	"Error Message List" on page 80
Other symptoms (i.e. LCD display problems or others).	"Power-On Self-Test (POST) Error Message" on page 79
Symptoms cannot be re-created (intermittent problems).	Use the customer-reported symptoms and go to "Power-On Self-Test (POST) Error Message" on page 79 "Intermittent Problems" on page 90 "Undetermined Problems" on page 91

System Check Procedures

External Diskette Drive Check

Do the following to isolate the problem to a controller, driver, or diskette. A write-enabled, diagnostic diskette is required.

NOTE: Make sure that the diskette does not have more than one label attached to it. Multiple labels can cause damage to the drive or cause the drive to fail.

Do the following to select the test device.

1. Boot from the diagnostics diskette and start the diagnostics program.
2. See if FDD Test is passed as the program runs to FDD Test.
3. Follow the instructions in the message window.

If an error occurs with the internal diskette drive, reconnect the diskette connector on the system board.

If the error still remains:

1. Reconnect the external diskette drive/DVD-ROM module.
2. Replace the external diskette drive/CD-ROM module.
3. Replace the main board.

External CD-ROM Drive Check

Do the following to isolate the problem to a controller, drive, or CD-ROM. Make sure that the CD-ROM does not have any label attached to it. The label can cause damage to the drive or can cause the drive to fail.

Do the following to select the test device:

1. Boot from the diagnostics diskette and start the diagnostics program.
2. See if CD-ROM Test is passed when the program runs to CD-ROM Test.
3. Follow the instructions in the message window.

If an error occurs, reconnect the connector on the System board. If the error still remains:

1. Reconnect the external diskette drive/CD-ROM module.
2. Replace the external diskette drive/CD-ROM module.
3. Replace the main board.

Keyboard or Auxiliary Input Device Check

Remove the external keyboard if the internal keyboard is to be tested.

If the internal keyboard does not work or an unexpected character appears, make sure that the flexible cable extending from the keyboard is correctly seated in the connector on the system board.

If the keyboard cable connection is correct, run the Keyboard Test.

If the tests detect a keyboard problem, do the following one at a time to correct the problem. Do not replace a non-defective FRU:

1. Reconnect the keyboard cables.
2. Replace the keyboard.
3. Replace the main board.

The following auxiliary input devices are supported by this computer:

- Numeric keypad
- External keyboard

If any of these devices do not work, reconnect the cable connector and repeat the failing operation.

Memory check

Memory errors might stop system operations, show error messages on the screen, or hang the system.

1. Boot from the diagnostics diskette and start the doagmpstotics program (please refer to main board).
2. Go to the diagnostic memory in the test items.
3. Press F2 in the test items.
4. Follow the instructions in the message window.

NOTE: Make sure that the DIMM is fully installed into the connector. A loose connection can cause an error.

Power System Check

To verify the symptom of the problem, power on the computer using each of the following power sources:

1. Remove the battery pack.
2. Connect the power adapter and check that power is supplied.
3. Disconnect the power adapter and install the charged battery pack; then check that power is supplied by the battery pack.

If you suspect a power problem, see the appropriate power supply check in the following list:

- "Check the Power Adapter" on page 77
- "Check the Battery Pack" on page 78

Check the Power Adapter

Unplug the power adapter cable from the computer and measure the output voltage at the plug of the power adapter cable. See the following figure

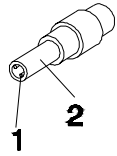

Pin 1: +19 to +20.5V
Pin 2: 0V, Ground

1. If the voltage is not correct, replace the power adapter.
2. If the voltage is within the range, do the following:
 - Replace the System board.
 - If the problem is not corrected, see “Undetermined Problems” on page 91.
 - If the voltage is not correct, go to the next step.

NOTE: An audible noise from the power adapter does not always indicate a defect.

3. If the power-on indicator does not light up, check the power cord of the power adapter for correct continuity and installation.
4. If the operational charge does not work, see “Check the Battery Pack” on page 78.

Check the Battery Pack

To check the battery pack, do the following:

From Software:

1. Check out the Power Management in control Panel
2. In Power Meter, confirm that if the parameters shown in the screen for Current Power Source and Total Battery Power Remaining are correct.
3. Repeat the steps 1 and 2, for both battery and adapter.
4. This helps you identify first the problem is on recharging or discharging.

From Hardware:

1. Power off the computer.
2. Remove the battery pack and measure the voltage between battery terminals 1(+) and 6(ground). See the following figure

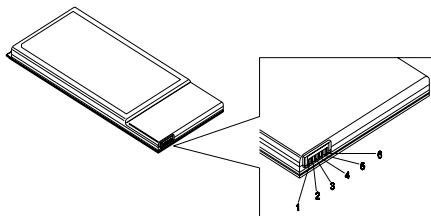

3. If the voltage is still less than 7.5 Vdc after recharging, replace the battery.

To check the battery charge operation, use a discharged battery pack or a battery pack that has less than 50% of the total power remaining when installed in the computer.

If the battery status indicator does not light up, remove the battery pack and let it return to room temperature. Re-install the battery pack.

If the charge indicator still does not light up, replace the battery pack. If the charge indicator still does not light up, replace the DC/DC charger board.

Touchpad Check

If the touchpad doesn't work, do the following actions one at a time to correct the problem. Do not replace a non-defective FRU:

1. Reconnect the touchpad cables.
2. Replace the touchpad.
3. Replace the system board.

After you use the touchpad, the pointer drifts on the screen for a short time. This self-acting pointer movement can occur when a slight, steady pressure is applied to the touchpad pointer. This symptom is not a hardware problem. No service actions are necessary if the pointer movement stops in a short period of time.

Power-On Self-Test (POST) Error Message

The POST error message index lists the error message and their possible causes. The most likely cause is listed first.

NOTE: Perform the FRU replacement or actions in the sequence shown in FRU/Action column, if the FRU replacement does not solve the problem, put the original part back in the computer. Do not replace a non-defective FRU.

This index can also help you determine the next possible FRU to be replaced when servicing a computer.

If the symptom is not listed, see “Undetermined Problems” on page 91.

The following lists the error messages that the BIOS displays on the screen and the error symptoms classified by function.

NOTE: Most of the error messages occur during POST. Some of them display information about a hardware device, e.g., the amount of memory installed. Others may indicate a problem with a device, such as the way it has been configured.

NOTE: If the system fails after you make changes in the BIOS Setup Utility menus, reset the computer, enter Setup and install Setup defaults or correct the error.

Index of Error Messages

Error Code List

Error Codes	Error Messages
006	Equipment Configuration Error Causes: 1. CPU BIOS Update Code Mismatch 2. IDE Primary Channel Master Drive Error (The causes will be shown before "Equipment Configuration Error")
010	Memory Error at xxxx:xxxx:xxxxh (R:xxxxh, W:xxxxh)
070	Real Time Clock Error
071	CMOS Battery Bad
072	CMOS Checksum Error
110	System disabled. Incorrect password is specified.
<No error code>	Battery critical LOW In this situation BIOS will issue 4 short beeps then shut down system, no message will show.
<No error code>	Thermal critical High In this situation BIOS will shut down system, not show message.

Error Message List

Error Messages	FRU/Action in Sequence
Failure Fixed Disk	Reconnect hard disk drive connector. "Load Default Settings" in BIOS Setup Utility. Hard disk drive System board
Stuck Key	see "Keyboard or Auxiliary Input Device Check" on page 75.
Keyboard error	see "Keyboard or Auxiliary Input Device Check" on page 75.
Keyboard Controller Failed	see "Keyboard or Auxiliary Input Device Check" on page 75.
Keyboard locked - Unlock key switch	Unlock external keyboard
Monitor type does not match CMOS - Run Setup	Run "Load Default Settings" in BIOS Setup Utility.
Shadow RAM Failed at offset: nnnn	BIOS ROM System board
System RAM Failed at offset: nnnn	DIMM System board
Extended RAM Failed at offset: nnnn	DIMM System board
System battery is dead - Replace and run Setup	Replace RTC battery and Run BIOS Setup Utility to reconfigure system time, then reboot system.
System CMOS checksum bad - Default configuration used	RTC battery Run BIOS Setup Utility to reconfigure system time, then reboot system.
System timer error	RTC battery Run BIOS Setup Utility to reconfigure system time, then reboot system. System board

Error Message List

Error Messages	FRU/Action in Sequence
Real time clock error	RTC battery Run BIOS Setup Utility to reconfigure system time, then reboot system. System board
Previous boot incomplete - Default configuration used	Run "Load Default Settings" in BIOS Setup Utility. RTC battery System board
Memory size found by POST differed from CMOS	Run "Load Default Settings" in BIOS Setup Utility. DIMM System board
Diskette drive A error	Check the drive is defined with the proper diskette type in BIOS Setup Utility See "External Diskette Drive Check" on page 75.
Incorrect Drive A type - run SETUP	Check the drive is defined with the proper diskette type in BIOS Setup Utility
System cache error - Cache disabled	System board
CPU ID:	System board
DMA Test Failed	DIMM System board
Software NMI Failed	DIMM System board
Fail-Safe Timer NMI Failed	DIMM System board
Device Address Conflict	Run "Load Default Settings" in BIOS Setup Utility. RTC battery System board
Allocation Error for device	Run "Load Default Settings" in BIOS Setup Utility. RTC battery System board
Failing Bits: nnnn	DIMM BIOS ROM System board
Fixed Disk n	None
Invalid System Configuration Data	BIOS ROM System board
I/O device IRQ conflict	Run "Load Default Settings" in BIOS Setup Utility. RTC battery System board
Operating system not found	Enter Setup and see if fixed disk and drive A: are properly identified. Diskette drive Hard disk drive System board

Error Message List

No beep Error Messages	FRU/Action in Sequence
No beep, power-on indicator turns off and LCD is blank.	Power source (battery pack and power adapter). See "Power System Check" on page 76. Ensure every connector is connected tightly and correctly. Reconnect the DIMM. LED board. System board.
No beep, power-on indicator turns on and LCD is blank.	Power source (battery pack and power adapter). See "Power System Check" on page 76. Reconnect the LCD connector Hard disk drive LCD inverter ID LCD cable LCD Inverter LCD System board
No beep, power-on indicator turns on and LCD is blank. But you can see POST on an external CRT.	Reconnect the LCD connectors. LCD inverter ID LCD cable LCD inverter LCD System board
No beep, power-on indicator turns on and a blinking cursor shown on LCD during POST.	Ensure every connector is connected tightly and correctly. System board
No beep during POST but system runs correctly.	Speaker System board

POST Code

Code	Beeps	POST Routine Description
02h		Verify Real Mode
03h		Disable Non-Maskable Interrupt (NMI)
04h		Get CPU type
06h		Initialize system hardware
08h		Initialize chipset with initial POST values
09h		Set IN POST flag
0Ah		Initialize CPU registers
0Bh		Enable CPU cache
0Ch		Initialize caches to initial POST values
0Eh		Initialize I/O component
0Fh		Initialize the local bus IDE
10h		Initialize Power Management
11h		Load alternate registers with initial POST values
12h		Restore CPU control word during warm boot
13h		Initialize PCI Bus Mastering devices
14h		Initialize keyboard controller
16h	1-2-2-3	BIOS ROM checksum
17h		Initialize cache before memory autosize
18h		8254 timer initialization
1Ah		8237 DMA controller initialization
1Ch		Reset Programmable Interrupt Controller
20h	1-3-1-1	Test DRAM refresh
22h	1-3-1-3	Test 8742 Keyboard Controller
24h		Set ES segment register to 4 GB
26h		Enable A20 line
28h		Autosize DRAM
29h		Initialize POST Memory Manager
2Ah		Clear 215 KB base RAM
2Ch	1-3-4-1	RAM failure on address line xxxx
2Eh	1-3-4-3	RAM failure on data bits xxxx of low byte of memory bus
2Fh		Enable cache before system BIOS shadow
30h	1-4-1-1	RAM failure on data bits xxxx of high byte of memory bus
32h		Test CPU bus-clock frequency
33h		Initialize Phoenix Dispatch Manager
36h		Warm start shut down
38h		Shadow system BIOS ROM
3Ah		Autosize cache
3Ch		Advanced configuration of chipset registers
3Dh		Load alternate registers with CMOS values
42h		Initialize interrupt vectors
45h		POST device initialization
46h	2-1-2-3	Check ROM copyright notice

Code	Beeps	POST Routine Description
48h		Check video configuration against CMOS
49h		Initialize PCI bus and devices
4Ah		Initialize all video adapters in system
4Bh		QuietBoot start (optional)
4Ch		Shadow video BIOS ROM
4Eh		Display BIOS copyright notice
50h		Display CPU type and speed
51h		Initialize EISA board
52h		Test keyboard
54h		Set key click if enabled
58h	2-2-3-1	Test for unexpected interrupts
59h		Initialize POST display service
5Ah		Display prompt "Press F2 to enter SETUP"
5Bh		Disable CPU cache
5Ch		Test RAM between 512 and 640 KB
60h		Test extended memory
62h		Test extended memory address lines
64h		Jump to User Patch1
66h		Configure advanced cache registers
67h		Initialize Multi Processor APIC
68h		Enable external and CPU caches
69h		Setup System Management Mode (SMM) area
6Ah		Display external L2 cache size
6Bh		Load custom defaults (optional)
6Ch		Display shadow-area message
6Eh		Display possible high address for UMB recovery
70h		Display error messages
72h		Check for configuration errors
76h		Check for keyboard errors
7Ch		Set up hardware interrupt vectors
7Eh		Initialize coprocessor if present
80h		Disable onboard Super I/O ports and IRQs
81h		Late POST device initialization
82h		Detect and install external RS232 ports
83h		Configure non-MCD IDE controllers
84h		Detect and install external parallel ports
85h		Initialize PC-compatible PnP ISA devices
86h		Re-initialize onboard I/O ports
87h		Configure Motherboard Configurable Devices (optional)
88h		Initialize BIOS Area
89h		Enable Non-Maskable Interrupts (NMIs)
8Ah		Initialize Extended BIOS Data Area
8Bh		Test and initialize PS/2 mouse
8Ch		Initialize floppy controller

Code	Beeps	POST Routine Description
8Fh		Determine number of ATA drives (optional)
90h		Initialize hard-disk controllers
91h		Initialize local-bus hard-disk controllers
92h		Jump to UserPatch2
93h		Build MPTABLE for multi-processor boards
95h		Install CD ROM for boot
96h		Clear huge ES segment register
97h		Fixup Multi Processor table
98h	1-2	Search for option ROMs. One long, two short beeps on checksum failure.
99h		Check for SMART drive (optional)
9Ah		Shadow option ROMs
9Ch		Set up Power Management
9Dh		Initialize security engine (optional)
9Eh		Enable hardware interrupts
9Fh		Determine number of ATA and SCSI drives
A0h		Set time of day
A2h		Check key lock
A4h		Initialize Typematic rate
A8h		Erase F2 prompt
AAh		Scan for F2 key stroke
ACh		Enter SETUP
A Eh		Clear Boot flag
B0h		Check for errors
B2h		POST done- prepare to boot operating system
B4h	1	One short beep before boot
B5h		Terminate QuietBoot (optional)
B6h		Check password (optional)
B9h		Prepare Boot
BAh		Initialize DMI parameters
BBh		Initialize PnP Option ROMs
BCh		Clear parity checkers
BDh		Display MultiBoot menu
BEh		Clear screen (optional)
BFh		Check virus and backup reminders
C0h		Try to boot with INT 19
C1h		Initialize POST Error Manager (PEM)
C2h		Initialize error logging
C3h		Initialize error display function
C4h		Initialize system error handler
C5h		PnPnd dual CMOS (optional)
C6h		Initialize notebook docking (optional)
C7h		Initialize notebook docking late
C8h		Force check (optional)
C9h		Extended checksum (optional)
D2h		Unknown interrupt

Code	Beeps	For Boot Block in Flash ROM
E0h		Initialize the chipset
E1h		Initialize the bridge
E2h		Initialize the CPU
E3h		Initialize the system timer
E4h		Initialize system I/O
E5h		Check force recovery boot
E6h		Checksum BIOS ROM
E7h		Go to BIOS
E8h		Set Huge Segment
E9h		Initialize Multi Processor
EAh		Initialize OEM special code
EBh		Initialize PIC and DMA
ECh		Initialize Memory type
EDh		Initialize Memory size
EEh		Shadow Boot Block
EFh		System memory test
F0h		Initialize interrupt vectors
F1h		Initialize Run Time Clock
F2h		Initialize video
F3h		Initialize System Management Mode
F4h	1	Output one beep before boot
F5h		Boot to Mini DOS
F6h		Clear Huge Segment
F7h		Boot to Full DOS

Index of Symptom-to-FRU Error Message

LCD-Related Symptoms

Symptom / Error	Action in Sequence
LCD backlight doesn't work LCD is too dark LCD brightness cannot be adjusted LCD contrast cannot be adjusted	Enter BIOS Utility to execute "Load Setup Default Settings", then reboot system. Reconnect the LCD connectors. Keyboard (if contrast and brightness function key doesn't work). LCD inverter ID LCD cable LCD inverter LCD System board
Unreadable LCD screen Missing pels in characters Abnormal screen Wrong color displayed	Reconnect the LCD connector LCD inverter ID LCD cable LCD inverter LCD System board
LCD has extra horizontal or vertical lines displayed.	LCD inverter ID LCD inverter LCD cable LCD System board

Indicator-Related Symptoms

Symptom / Error	Action in Sequence
Indicator incorrectly remains off or on, but system runs correctly	Reconnect the inverter board Inverter board System board

Power-Related Symptoms

Symptom / Error	Action in Sequence
Power shuts down during operation	Power source (battery pack and power adapter). See "Power System Check" on page 76. Battery pack Power adapter Hard drive & battery connection board System board
The system doesn't power-on.	Power source (battery pack and power adapter). See "Power System Check" on page 76. Battery pack Power adapter Hard drive & battery connection board System board
The system doesn't power-off.	Power source (battery pack and power adapter). See "Power System Check" on page 76. Hold and press the power switch for more than 4 seconds. System board
Battery can't be charged	See "Check the Battery Pack" on page 78. Battery pack System board

PCMCIA-Related Symptoms

Symptom / Error	Action in Sequence
System cannot detect the PC Card (PCMCIA)	PCMCIA slot assembly System board
PCMCIA slot pin is damaged.	PCMCIA slot assembly

Memory-Related Symptoms

Symptom / Error	Action in Sequence
Memory count (size) appears different from actual size.	Enter BIOS Setup Utility to execute "Load Default Settings, then reboot system. DIMM System board

Speaker-Related Symptoms

Symptom / Error	Action in Sequence
In Windows, multimedia programs, no sound comes from the computer.	Audio driver Speaker System board
Internal speakers make noise or emit no sound.	Speaker System board

Power Management-Related Symptoms

Symptom / Error	Action in Sequence
The system will not enter hibernation	Keyboard (if control is from the keyboard) Hard disk drive System board
The system doesn't enter hibernation mode and four short beeps every minute.	See "Hibernation Mode" on page 30. Press Fn+F4 and see if the computer enters hibernation mode. Touchpad Keyboard Hard disk connection board Hard disk drive System board
The system doesn't enter standby mode after closing the LCD	See "Hibernation Mode" on page 30. LCD cover switch System board
The system doesn't resume from hibernation mode.	See "Hibernation Mode" on page 30. Hard disk connection board Hard disk drive System board
The system doesn't resume from standby mode after opening the LCD.	See "Hibernation Mode" on page 30. LCD cover switch System board
Battery fuel gauge in Windows doesn't go higher than 90%.	Remove battery pack and let it cool for 2 hours. Refresh battery (continue use battery until power off, then charge battery). Battery pack System board

Power Management-Related Symptoms

Symptom / Error	Action in Sequence
System hangs intermittently.	Reconnect hard disk/CD-ROM drives. Hard disk connection board System board

Peripheral-Related Symptoms

Symptom / Error	Action in Sequence
System configuration does not match the installed devices.	Enter BIOS Setup Utility to execute "Load Default Settings", then reboot system. Reconnect hard disk/CD-ROM/diskette drives.
External display does not work correctly.	Press Fn+F5, LCD/CRT/Both display switching System board
USB does not work correctly	System board
Print problems.	Ensure the "Parallel Port" in the "Onboard Devices Configuration" of BIOS Setup Utility is set to Enabled. Onboard Devices Configuration Run printer self-test. Printer driver Printer cable Printer System Board
Serial or parallel port device problems.	Ensure the "Serial Port" in the Devices Configuration" of BIOS Setup Utility is set to Enabled. Device driver Device cable Device System board

Keyboard/Touchpad-Related Symptoms

Symptom / Error	Action in Sequence
Keyboard (one or more keys) does not work.	Reconnect the keyboard cable. Keyboard System board
Touchpad does not work.	Reconnect touchpad cable. Touchpad board System board

Modem-Related Symptoms

Symptom / Error	Action in Sequence
Internal modem does not work correctly.	Modem phone port modem combo board System board

NOTE: If you cannot find a symptom or an error in this list and the problem remains, see "Undetermined Problems" on page 91.

Intermittent Problems

Intermittent system hang problems can be caused by a variety of reasons that have nothing to do with a hardware defect, such as: cosmic radiation, electrostatic discharge, or software errors. FRU replacement should be considered only when a recurring problem exists.

When analyzing an intermittent problem, do the following:

1. Run the advanced diagnostic test for the system board in loop mode at least 10 times.
2. If no error is detected, do not replace any FRU.
3. If any error is detected, replace the FRU. Rerun the test to verify that there are no more errors.

Undetermined Problems

The diagnostic problems does not identify which adapter or device failed, which installed devices are incorrect, whether a short circuit is suspected, or whether the system is inoperative.

Follow these procedures to isolate the failing FRU (do not isolate non-defective FRU).

NOTE: Verify that all attached devices are supported by the computer.

NOTE: Verify that the power supply being used at the time of the failure is operating correctly. (See "Power System Check" on page 76):

1. Power-off the computer.
2. Visually check them for damage. If any problems are found, replace the FRU.
3. Remove or disconnect all of the following devices:
 - Non-Acer devices
 - Printer, mouse, and other external devices
 - Battery pack
 - Hard disk drive
 - DIMM
 - CD-ROM/Diskette drive Module
 - PC Cards
4. Power-on the computer.
5. Determine if the problem has changed.
6. If the problem does not recur, reconnect the removed devices one at a time until you find the failing FRU.
7. If the problem remains, replace the following FRU one at a time. Do not replace a non-defective FRU:
 - System board
 - LCD assembly

How to Build NAPP Master Hard Disc Drive

CD to Disk Recovery

1. Prepare NAPP CD, Recovery CD and System CD.
2. Put NAPP CD into the optical drive. Then boot up the system.
3. The system will ask you if you want to build NAPP Master HDD. Please press any key to continue.

```
=====
                        The HDD Must bigger then 20GB.
=====

Do you want to build NAPP Master HDD?
press any key to continue or Ctrl-C to exit
_
```

4. NAPP CD will start to preload the system, please click [Y].

```
Acer NAPP Preload Selector for Acer System Version 1.4.0.1
Copyright 2003 Acer Inc.

=====

This will preload your system. Are you sure?[Y,N]?
```

5. Select CD to Disk Recovery.

```
Method Selector
=====
1. Disk To Disk Recovery
2. CD to Disk Recovery
X. Quit

Please select your Choose...[1,2,x]?
```

- Put the Recovery CD to the optical drive. This step is to create image files to the system, you do not have to put the Recovery CD to the optical drive in order. Place one Recovery CD to the drive at one time till you finish all Recovery CDs.

```
Please Insert Any Recovery CD

Please Press Any Key to Continue.
Press any key to continue...
_
```

After you place the Recovery CD to the optical drive, you will see the display below.

```
Please Wait for COPYING .....  
X:\images \70E40101.HDD
```

7. Then insert the System CD to the optical drive.

```
Please Insert the System CD  
  
Please Press Any Key to Continue.  
Press any key to continue...  
_
```

8. You will see the screen displaying "PASS" when the system has built NAPP Master hard disc drive.



Disk to Disk Recovery

1. Prepare NAPP CD, Recovery CD and System CD.
2. Put NAPP CD into the optical drive. Then boot up the system.
3. The system will ask you if you want to build NAPP Master HDD. Please press any key to continue.



4. NAPP CD will start to preload the system, please click [Y].

```
Acer NAPP Preload Selector for Acer System Version 1.4.0.1
Copyright 2003 Acer Inc.
```

```
=====
This will preload your system. Are you sure?[Y,N]?
```

5. Select Disk to Disk Recovery. Then choose Single Language or Multi-Languages Recovery.
NOTE: For Multi-Languages Recovery, not more than five languages could be loaded to the system.

```
Method Selector
```

- ```
=====
1. Single Language Recovery
2. Multi-Languages Recovery
X. Quit
```

```
Please select your Choose...[1,2,x]?
```

6. Put the Recovery CD to the optical drive. This step is to create image files to the system, you do not have to put the Recovery CD to the optical drive in order. Place one Recovery CD to the drive at one time till you finish all Recovery CDs.

---



```
Please Insert Any Recovery CD

Please Press Any Key to Continue.
Press any key to continue...
_
```

After you place the Recovery CD to the optical drive, you will see the display below.



```
Please Wait for COPYING
X:\images \70E40101.HDD
```

7. Then insert the System CD to the optical drive.

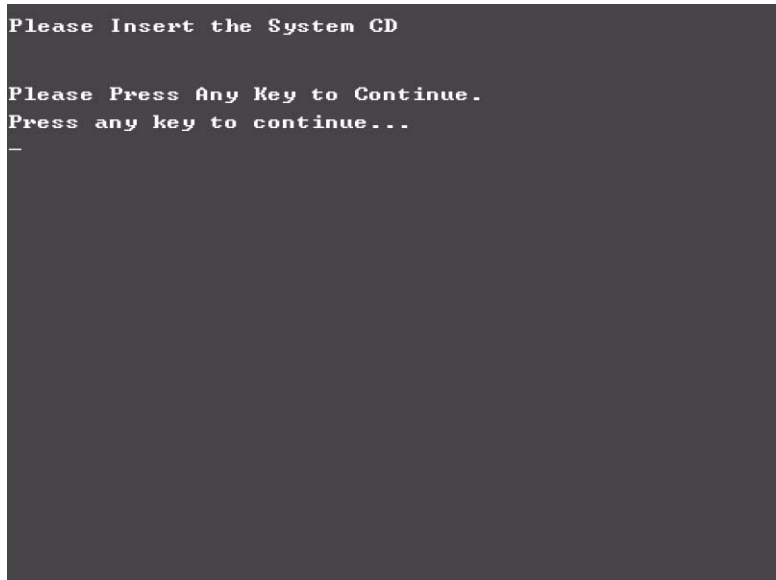

- 8. You will see the screen displaying "PASS" when the system has buit NAPP Master hard disc drive.





## Jumper and Connector Locations

### Top View

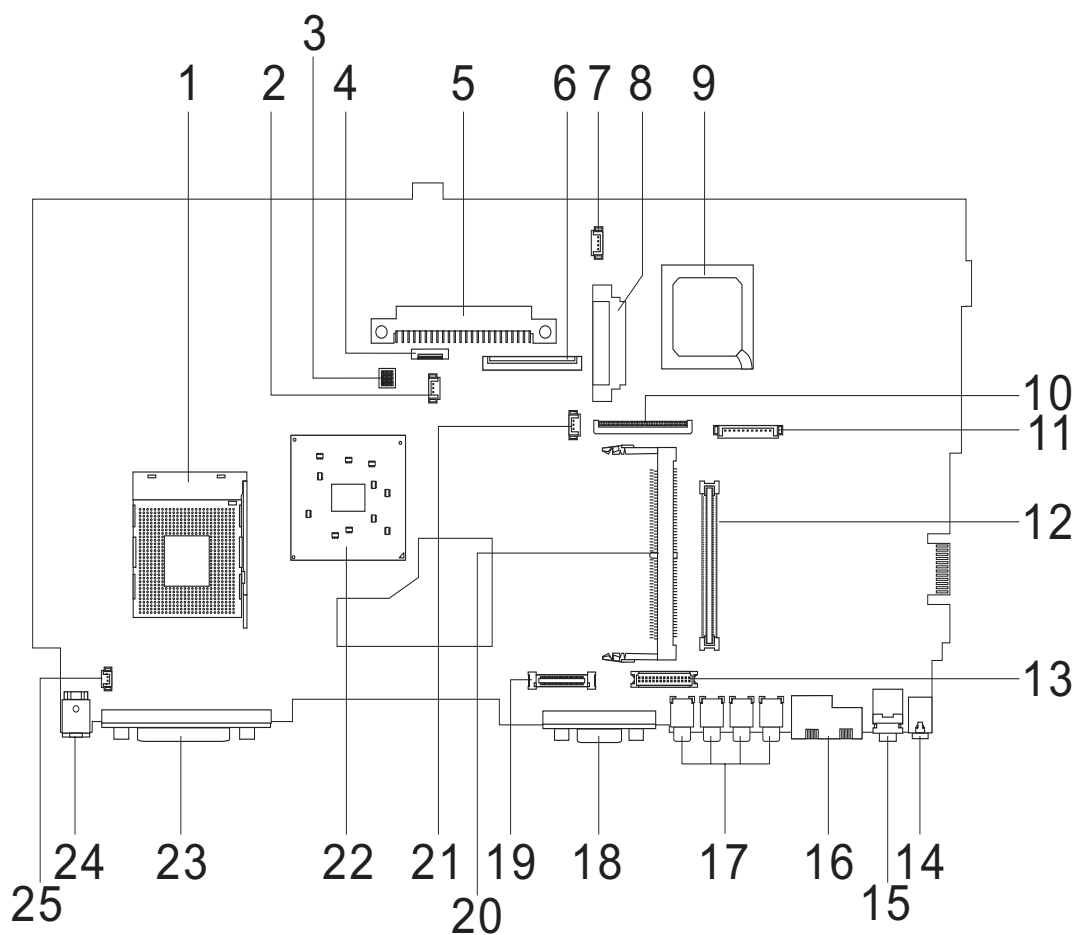

---

|    |         |                              |    |        |                             |
|----|---------|------------------------------|----|--------|-----------------------------|
| 1  | U12     | CPU Socket                   | 14 | LIN1   | Line-in Port                |
| 2  | FAN1    | Fan Connector                | 15 | LOUT1  | Line-out Port               |
| 3  | SW1     | SW1                          | 16 | RJ1    | RJ45+RJ11                   |
| 4  | TPAD1   | Touchpad Cable Connector     | 17 | USB1-4 | Four USB Ports              |
| 5  | HDD1    | HDD Connector                | 18 | CRT1   | VGA Port                    |
| 6  | KB1     | Keyboard Connector           | 19 | LCD1   | LCD Coaxial Cable Connector |
| 7  | SPK1    | Speaker Cable Connector      | 20 | MINI1  | Mini PCI Connector          |
| 8  | IDE1    | Optical Drive Connector      | 21 | RTC1   | RTC Battery Connector       |
| 9  | U23     | South Bridge                 | 22 | U15    | North Bridge                |
| 10 | FDD1    | FDD Connector                | 23 | PRT1   | Parallel Port               |
| 11 | CN1     | Launch Cable Connector       | 24 | DCIN1  | DC-in Port                  |
| 12 | CBUS1,2 | PCMCIA Slot                  | 25 | CVR1   | LCD Lid Switch              |
| 13 | INV1    | LCD Inverter Cable Connector |    |        |                             |

**Bottom View**

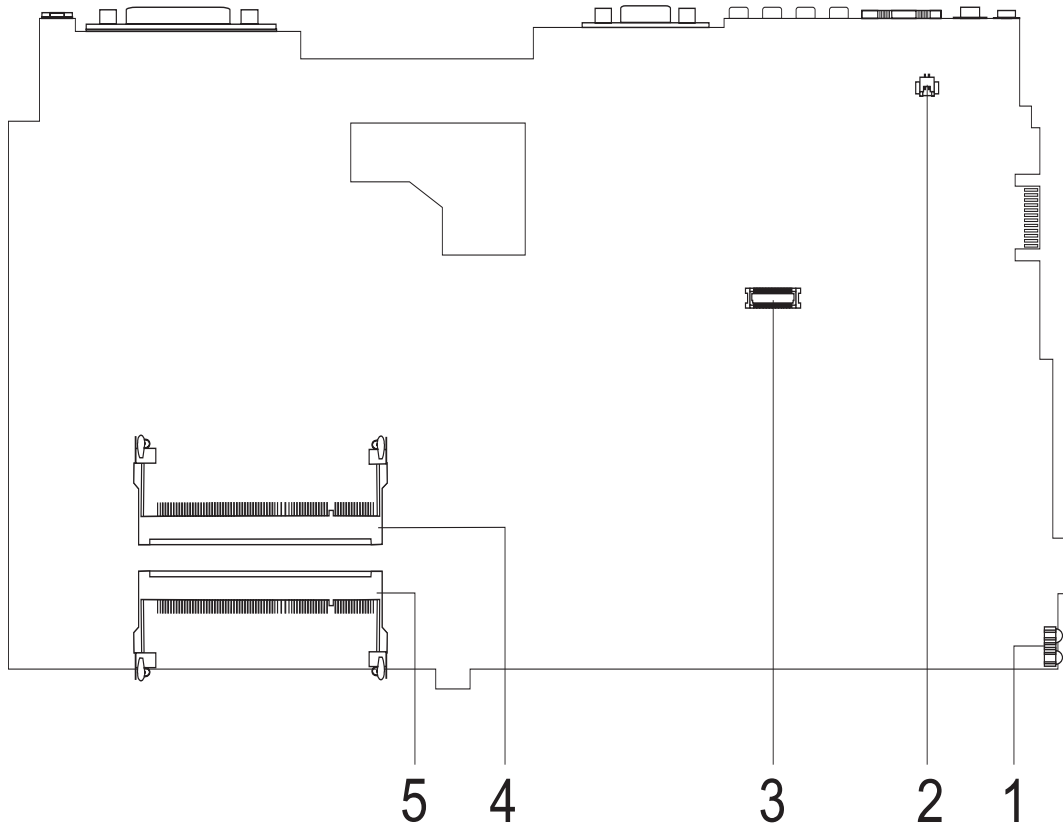

- 1 U7 FIR Port
- 2 RING1 Modem Cable Connector
- 3 MDC1 Modem Card Connector
- 4 DM1 DIMM Socket 1
- 5 DM2 DIMM Socket 2

**SW1 Settings**

|                   | 1   | 2   | 3   | 4 |
|-------------------|-----|-----|-----|---|
| Password Enable   | ON  | X   | X   | X |
| Password Disable  | OFF | X   | X   | X |
| Bootblock Enable  | X   | ON  | X   | X |
| Bootblock Disable | X   | OFF | X   | X |
| Adapter 90W       | X   | X   | ON  | X |
| Adapter 120W      | X   | X   | OFF | X |





## ***FRU (Field Replaceable Unit) List***

---

This chapter gives you the FRU (Field Replaceable Unit) listing in global configurations of Extensa 2000/2500. Refer to this chapter whenever ordering for parts to repair or for RMA (Return Merchandise Authorization).

Please note that WHEN ORDERING FRU PARTS, you should check the most up-to-date information available on your regional web or channel. For whatever reasons a part number change is made, it will not be noted on the printed Service Guide. For ACER AUTHORIZED SERVICE PROVIDERS, your Acer office may have a DIFFERENT part number code from those given in the FRU list of this printed Service Guide. You MUST use the local FRU list provided by your regional Acer office to order FRU parts for repair and service of customer machines.

**NOTE:** To scrap or to return the defective parts, you should follow the local government ordinance or regulations on how to dispose it properly, or follow the rules set by your regional Acer office on how to return it.



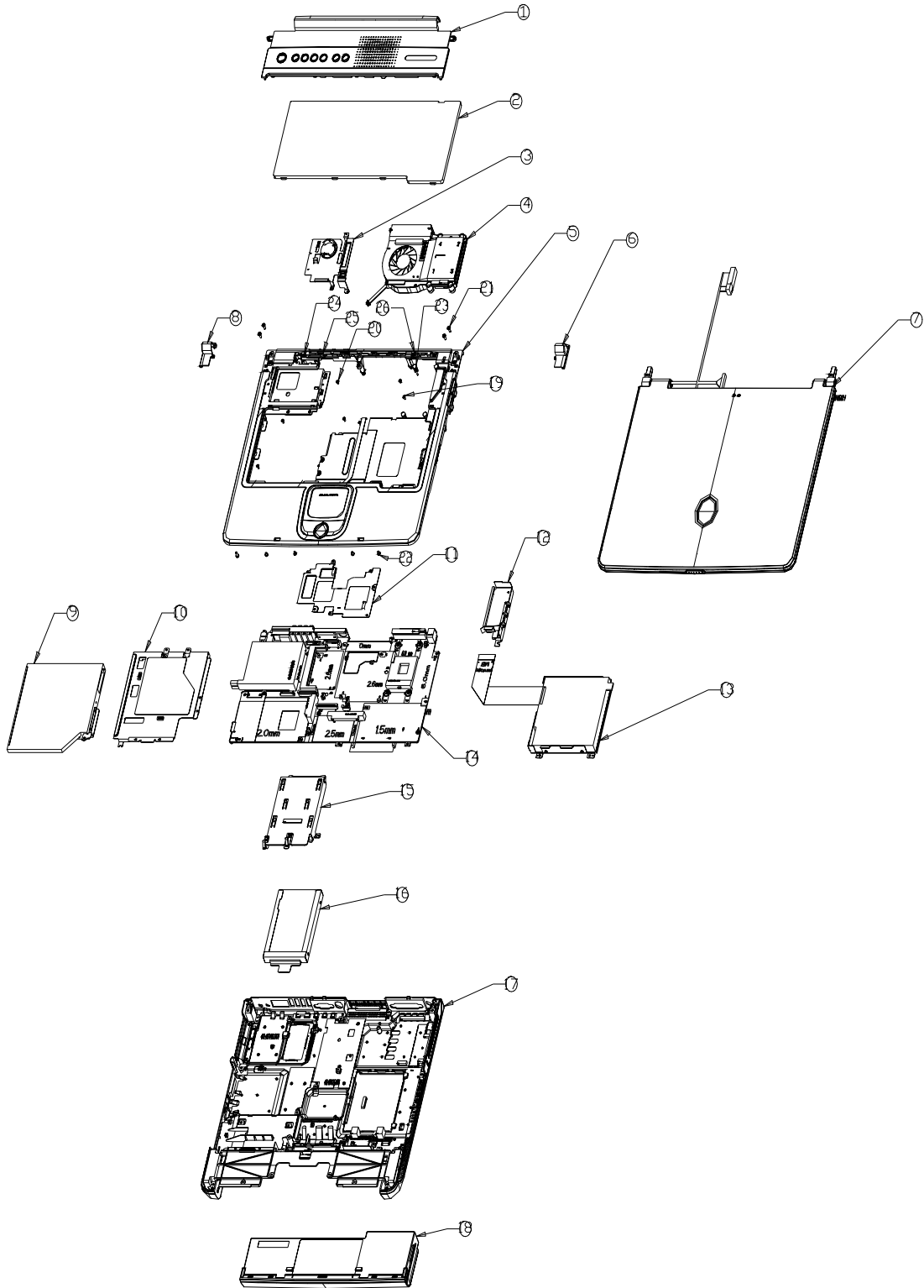

# Extensa 2000/2500 Exploded Diagram



## Extensa 2000 FRU List

| Picture                                                                             | No. | Partname And Description                              | Part Number  |
|-------------------------------------------------------------------------------------|-----|-------------------------------------------------------|--------------|
| <b>Adapter</b>                                                                      |     |                                                       |              |
|    |     | ADAPTER 135W 19V 3PIN<br>LITEON PA-1131-08AC          | AP.13503.001 |
|                                                                                     |     | ADAPTER 135W 19V 3PIN LISHIN<br>0317A19135            | TBD          |
|                                                                                     |     | ADAPTER 135W 19V 3PIN HIPRO<br>OW135F13               | TBD          |
| <b>Battery</b>                                                                      |     |                                                       |              |
|    |     | RTC BATTERY                                           | 23.T30V1.001 |
|    | 18  | BATTERY MODULE LI-ON 8CELL<br>SIMPLO                  | 6M.A20V1.001 |
|                                                                                     |     | BATTERY MODULE LI-ON<br>12CELL SANYO                  | TBD          |
|   |     | BATTERY PACK LI-ON 8CELL<br>PANASONIC                 | BT.T3007.003 |
|                                                                                     |     | BATTERY LI-ON 8CELL SANYO                             | BT.T3003.001 |
|                                                                                     |     | BATTERY PACK LI-ON 12CELL<br>SANYO                    | TBD          |
| <b>CASE/COVER/BRACKET ASSEMBLY</b>                                                  |     |                                                       |              |
|  |     | BATTERY COVER                                         | 42.T30V1.001 |
| <b>Boards</b>                                                                       |     |                                                       |              |
|  |     | DC-DC CHARGER BOARD                                   | 55.T30V1.001 |
|  |     | WIRELESS LAN BOARD AMBIT<br>802.11B T60H656.02 REV.03 | 54.03096.022 |
|                                                                                     |     | WIRELESS LAN BOARD 802.11G<br>WNC MIMIPCI             | 54.A16V1.001 |

## Extensa 2000 FRU List

| Picture                                                                             | No. | Partname And Description                  | Part Number  |
|-------------------------------------------------------------------------------------|-----|-------------------------------------------|--------------|
|    |     | LAUNCH BOARD                              | 55.T30V1.002 |
|    |     | MODEM BOARD AMBIT<br>T60M283.10(01)       | 54.09011.544 |
|                                                                                     |     | MODEM/BLUETOOTH BOARD<br>AMBIT T60M665.00 | 54.09061.001 |
| <b>Cables</b>                                                                       |     |                                           |              |
|    |     | COVER SWITCH CABLE                        | TBD          |
|   |     | LAUNCH CABLE                              | 50.T30V1.011 |
|  |     | MODEM CABLE 2PIN<br>2CONNECTOR 55MM       | 50.41T11.002 |
|                                                                                     |     | POWER CORD US (3 pin)                     | 27.01618.051 |
| <b>Case/Cover/Bracket Assembly</b>                                                  |     |                                           |              |
|  | 3   | MINI PCI CARD PLATE W/RTC<br>HOLDER       | 60.T30V1.003 |
|  | 6   | HINGE CAP RIGHT                           | 42.E02V1.001 |
|  | 8   | HINGE CAP LEFT                            | 42.E02V1.002 |

**Extensa 2000 FRU List**

| Picture                                                                             | No. | Partname And Description                                                        | Part Number  |
|-------------------------------------------------------------------------------------|-----|---------------------------------------------------------------------------------|--------------|
|    | 10  | OPTICAL DRIVE SUPPORT BRACKET                                                   | 33.T30V1.001 |
|    | 15  | HDD BRACKET                                                                     | 33.A20V1.001 |
|    | 16  | HDD HOLDER                                                                      | 33.T30V1.003 |
|                                                                                     | 17  | LOWER CASE W/DIMM COVER& SPEAKER W/O MDC COVER (USE FOR FDD)                    | 60.T45V1.001 |
|                                                                                     |     | LOWER CASE W/DIMM COVER& SPEAKER W/O MDC COVER (USE FOR NON-FDD)                | 60.T45V1.002 |
|  |     | MODEM COVER W/SCREW                                                             | 42.A20V1.001 |
|  |     | DIMM COVER W/SCREW                                                              | TBD          |
|                                                                                     | 19  | UPPER CASE W/COVER SWITCH CABLE & TOUCHPAD CABLE & SCROLL KEY (USE FOR FDD)     | 60.E01V1.001 |
|                                                                                     |     | UPPER CASE W/COVER SWITCH CABLE & TOUCHPAD CABLE & SCROLL KEY (USE FOR NON-FDD) | 60.E01V2.002 |
|  |     | TOUCHPAD COVER                                                                  | 42.T30V1.006 |

## Extensa 2000 FRU List

| Picture                                                                             | No. | Partname And Description            | Part Number  |
|-------------------------------------------------------------------------------------|-----|-------------------------------------|--------------|
|    |     | 2ND FAN BRACKET                     | 33.A29V1.002 |
|                                                                                     |     | MIDDLE COVER W/LAUNCH BOARD         | TBD          |
| Communication Module                                                                |     |                                     |              |
|    |     | WIRELESS ANTENNA RIGHT (BLACK)      | 50.A20V1.001 |
|    |     | WIRELESS ANTENNA LEFT (GRAY)        | 50.A20V1.002 |
|                                                                                     |     | BLUETOOTH ANTENNA                   | 50.A20V1.004 |
| CPU                                                                                 |     |                                     |              |
|   |     | CPU 2.7GMHZ 400FSB INTEL            | KC.DCD01.27A |
|                                                                                     |     | CPU 2.8GMHZ 400FSB INTEL            | KC.DCD01.28A |
|                                                                                     |     | CPU 2.5GMHZ 400FSB INTEL            | KC.DCD01.25A |
|                                                                                     |     | CPU 2.8GMHZ 533FSB INTEL            | KC.DCP01.28B |
|                                                                                     |     | CPU 2.4GMHZ 400FSB INTEL            | KC.DCD01.24A |
|                                                                                     |     | CPU 2.6GMHZ 400FSB INTEL            | KC.DCD01.26A |
|  |     | FAN 2ND                             | 23.A20V1.001 |
| FDD/Floppy Disk Drive                                                               |     |                                     |              |
|  | 13  | FDD MODULE 1.44M MCI JU-226A033FC   | 6M.T45V1.004 |
|                                                                                     |     | FDD MODULE 1.44M MITSUMI D353G 4515 | 6M.T45V1.005 |

## Extensa 2000 FRU List

| Picture                                                                            | No. | Partname And Description              | Part Number  |
|------------------------------------------------------------------------------------|-----|---------------------------------------|--------------|
|   |     | FDD MODULE 1.44M PANASONIC JU-226A033 | KF.T3007.001 |
|                                                                                    |     | FDD MODULE 1.44M MITSUMI D353G 4515   | KF.T3006.001 |
|   |     | FDD BRACKET                           | 33.T30V1.005 |
|   |     | FDD CABLE                             | 50.T30V1.003 |
| <b>HDD/ Hard Disk Drive</b>                                                        |     |                                       |              |
|  |     | HDD 20G HITACHI IC25N020ATMR04        | KH.02007.006 |
|                                                                                    |     | HDD 30GB HITACHI IC25N030ATMR04       | KH.03007.005 |
|                                                                                    |     | HDD 30GB FUJITSU MHT2030AT 009B A3    | KH.03006.004 |
|                                                                                    |     | HDD 30GB SEAGATE ST93015A 4.05        | KH.03001.001 |
|                                                                                    |     | HDD 30G TOSHIBA MK3021GAS             | KH.33004.001 |
|                                                                                    |     | HDD 40GB HITACHI IC25N040ATMR04       | KH.04007.009 |
|                                                                                    |     | HDD 40G TOSHIBA MK4025GAS             | KH.04004.002 |
|                                                                                    |     | HDD 40GB FUJITSU MHT2040AT 0022 A3    | KH.04006.004 |
|                                                                                    |     | HDD 40G SEAGATE ST94019A              | KH.04001.010 |
|                                                                                    |     | HDD 60GB HITACHI IC25N060ATMR04       | KH.06007.006 |
|                                                                                    |     | HDD 60GB HITACHI DK23FA-60 A0A0       | KH.06007.005 |
|                                                                                    |     | HDD 60G TOSHIBA MK6021GAS             | KH.36004.001 |
|                                                                                    |     | HDD 60G HITACHI DK23FA-60 A0A0        | KH.06007.005 |
|                                                                                    |     | HDD 60G TOSHIBA MK6021GAS             | KH.36004.001 |
|                                                                                    |     | HDD 80G HITACHI IC25N080ATMR04        | KH.08007.002 |

## Extensa 2000 FRU List









| Picture                                                                           | No. | Partname And Description            | Part Number  |
|-----------------------------------------------------------------------------------|-----|-------------------------------------|--------------|
|                                                                                   |     | HDD 80GB TOSHIBA MK8025GAS KA023A   | KH.08004.001 |
| Heatsink                                                                          |     |                                     |              |
|  | 4   | CPU FANSINK                         | 34.T45V1.003 |
|  | 4   | CPU THERMAL PLATE                   | 34.A20V1.001 |
|                                                                                   |     | VGA THERMAL PLATE                   | 34.T45V1.001 |
|  |     | VGA THERMAL PLATE                   | 33.A20V1.003 |
| Keyboard                                                                          |     |                                     |              |
|  | 2   | KEYBOARD DARFON NSK-ACY0G GERMANY   | KB.A1907.001 |
|                                                                                   |     | KEYBOARD DARFON NSK-ACY1D USI       | KB.T3007.047 |
|                                                                                   |     | KEYBOARD DARFON NSK-ACY0U UK        | KB.T3007.052 |
|                                                                                   |     | KEYBOARD DARFON NSK-ACY0J JPN       |              |
|                                                                                   |     | KEYBOARD DARFON NSK-ACY06 PORTUGUE  | KB.A2007.004 |
|                                                                                   |     | KEYBOARD DARFON NSK-ACY0A ARABIC    | KB.A2007.005 |
|                                                                                   |     | KEYBOARD DARFON NSK-ACY1A BELGIAN   | KB.A2007.006 |
|                                                                                   |     | KEYBOARD DARFON NSK-ACY0W SWEDISH   | KB.A2007.007 |
|                                                                                   |     | KEYBOARD DARFON NSK-ACY0C CZECH     | KB.A2007.008 |
|                                                                                   |     | KEYBOARD DARFON NSK-ACY0Q HUNGARIAN | KB.A2007.009 |
|                                                                                   |     | KEYBOARD DARFON NSK-ACY0N NORWAY    | KB.A2007.010 |
|                                                                                   |     | KEYBOARD DARFON NSK-ACY0D DANISH    | KB.A2007.011 |
|                                                                                   |     | KEYBOARD DARFON NSK-ACY0T TURKISH   | KB.A2007.012 |
|                                                                                   |     | KEYBOARD DARFON NSK-ACY0M FRE/CAN   | KB.A2007.013 |
|                                                                                   |     | KEYBOARD DARFON NSK-ACY0L GREEK     | KB.A2007.014 |





### Extensa 2000 FRU List

| Picture                                                                             | No. | Partname And Description               | Part Number  |
|-------------------------------------------------------------------------------------|-----|----------------------------------------|--------------|
|                                                                                     |     | KEYBOARD DARFON NSK-ACY0R RUSSIAN      | KB.A2007.015 |
|                                                                                     |     | KEYBOARD DARFON NSK-ACY02 TAIWAN       | KB.A2007.016 |
|                                                                                     |     | KEYBOARD DARFON NSK-ACY0S SPANISH      | KB.A2007.017 |
|                                                                                     |     | KEYBOARD DARFON NSK-ACY03 THAILAND     | KB.A2007.018 |
|                                                                                     |     | KEYBOARD DARFON NSK-ACY1B BRAZILIAN    | KB.A2007.019 |
|                                                                                     |     | KEYBOARD DARFON NSK-ACY0E ITALY        | KB.A2007.021 |
|                                                                                     |     | KEYBOARD DARFON NSK-ACY0F FRENCH       | KB.A2007.022 |
|                                                                                     |     | KEYBOARD DARFON NSK-ACY0K KOREAN       | KB.A2007.023 |
|                                                                                     |     | KEYBOARD DARFON NSK-ACY00 SWISS        | KB.A2007.024 |
| LCD                                                                                 |     |                                        |              |
|    |     | LCD 14.1" TFT XGA AU B141XN04 V2/5AXXX | LK.14105.005 |
|                                                                                     |     | LCD 15" XGA TFT CHIMEI N150X3-L05 C2   | LK.1500D.004 |
|                                                                                     |     | LCD 15" XGA TFT QDI QD15XL06-01        | LK.15009.002 |
|                                                                                     |     | LCD 15" XGA LG LP150X08-A5             | LK.15008.012 |
|  |     | INVERTER BOARD 15" SUMIDA              | 19.T30V1.201 |
|                                                                                     |     | INVERTER BOARD 14"/15"                 | 19.21030.I71 |
|  |     | LCD BRACKET RIGHT FOR 14.1"            | 33.T30V1.006 |
|                                                                                     |     | LCD BRACKET RIGHT FOR 15"              | 33.A16V1.002 |
|  | NS  | LCD BRACKET LEFT FOR 14.1"             | 33.T30V1.007 |
|                                                                                     |     | LCD BRACKET LEFT FOR 15"               | 33.A16V1.003 |
|  |     | INVERTER CABLE                         | 50.T30V1.007 |

### Extensa 2000 FRU List

| Picture                                                                             | No. | Partname And Description                                            | Part Number  |
|-------------------------------------------------------------------------------------|-----|---------------------------------------------------------------------|--------------|
|    |     | LCD COAXIAL CABLE 14"                                               | 50.A20V1.003 |
|                                                                                     |     | LCD COAXIAL CABLE 15"                                               | 50.49V06.002 |
|    | NS  | LCD PANEL W/HINGE & LOGO                                            | TBD          |
|    | NS  | LCD BEZEL W/ICON PLATE                                              | TBD          |
|    |     | HINGE PACK                                                          | TBD          |
| <b>Main Board</b>                                                                   |     |                                                                     |              |
|  |     | MAINBOARD W/O CPU W/ MODEM CABLE & LAUNCH BOARD CABLE (USE FOR FDD) | TBD          |
|                                                                                     |     | MAINBOARD W/O CPU W/ MODEM CABLE & LAUNCH BOARD CABLE               | LB.T4501.001 |
| <b>Miscellaneous</b>                                                                |     |                                                                     |              |
|                                                                                     |     | LCD SCREW RUBBER                                                    | 47.T45V1.001 |
|                                                                                     |     | LCD SCREW RUBBER                                                    | 47.T45V1.002 |
|  |     | LOGO                                                                | TBD          |
|                                                                                     |     | RUBBER FOOT                                                         | TBD          |
|  |     | TOUCHPAD KNOB                                                       | 42.T30V1.008 |
|  |     | ICON LABEL                                                          | 40.T30V1.001 |



## Extensa 2000 FRU List

| Picture                                                                             | No.                               | Partname And Description                           | Part Number  |
|-------------------------------------------------------------------------------------|-----------------------------------|----------------------------------------------------|--------------|
|                                                                                     |                                   | NAME PLATE                                         | 40.E01V1.001 |
| Memory                                                                              |                                   |                                                    |              |
|    | NS                                | SODIMM 128M INFINEON<br>HYS64D16000GDL-6-B         | KN.12802.006 |
|                                                                                     |                                   | SODIMM 256M INFINEON<br>HYS64D32020GDL-6-B         | KN.25602.009 |
|                                                                                     |                                   | SODIMM256M NANYA<br>NT256D64SH8BAGM-6KE            | KN.25603.014 |
|                                                                                     |                                   | SODIMM256M MICRON 256M<br>MT8VDDT3264HDG-335       | KN.25604.009 |
|                                                                                     |                                   | SODIMM 512M INFINEON<br>HYS64D64020GBDL-6-B        | KN.51202.007 |
|                                                                                     |                                   | SODIMM 512M NANYA<br>NT512D64S8HBAFM-6K            | KN.51203.005 |
| Optical Drive                                                                       |                                   |                                                    |              |
|   |                                   | CD-ROM MODULE 24X                                  | 6M.A20V1.001 |
|                                                                                     |                                   | CDRW/DVD COMBO MODULE<br>24X                       | 6M.A20V1.002 |
|                                                                                     |                                   | DVD-RW MODULE 2X TOSHIBA<br>SD-R6112               | 6M.T45V1.001 |
|                                                                                     |                                   | DVD-RW MODULE 2X HLDS<br>GWA-4040N                 | 6M.T45V1.002 |
|                                                                                     |                                   | DVD-SUPER MULTI DRIVE 2X UJ-<br>820B-A             | 6M.T45V1.003 |
|  |                                   | CD-ROM DRIVE 24X MITSUMI<br>SR244W1                | KD.24X04.002 |
|                                                                                     |                                   | CD-ROM DRIVE 24X QSI SCR-242                       | 56.10291.021 |
|                                                                                     |                                   | CDRW/DVD COMBO DRIVE 24X<br>PANASONIC UJDA750WS4-A | KO.02403.002 |
|                                                                                     |                                   | CDRW/DVD COMBO DRIVE 24X<br>QSI SBW-242B           | KO.02407.011 |
|                                                                                     |                                   | DVD-RW DRIVE 2X TOSHIBA SD-<br>R6112               | KW.00201.003 |
|                                                                                     |                                   | DVD-RW DRIVE 2X HLDS GWA-<br>4040N                 | KU.0040D.001 |
|                                                                                     |                                   | DVD-RW DRIVE 2X PIONEER<br>DVR-K12D                | KU.00405.012 |
|                                                                                     | DVD-RW DRIVE 2X KME UJ-820B-<br>A | TBD                                                |              |
|  |                                   | OPTICAL DRIVE BRACKET                              | 33.T30V1.004 |
| PCMCIA slot/PC card slot                                                            |                                   |                                                    |              |
|                                                                                     |                                   | PCMCIA SLOT                                        | 22.T30V1.001 |
| Pointing Device                                                                     |                                   |                                                    |              |







### Extensa 2000 FRU List

| Picture                                                                           | No. | Partname And Description     | Part Number  |
|-----------------------------------------------------------------------------------|-----|------------------------------|--------------|
|  | NS  | TOUCHPAD SYNAPTICS TM41P-357 | 56.17001.001 |
| Screws                                                                            |     |                              |              |
|                                                                                   | NS  | SCREW                        | 86.T30V1.001 |
|                                                                                   | NS  | SCREW                        | 86.9A352.3R0 |
|                                                                                   | NS  | SCREW                        | 86.9A353.6R0 |
|                                                                                   | NS  | SCREW                        | 86.9A524.4R0 |
|                                                                                   | NS  | SCREW                        | 86.9A552.2R0 |
|                                                                                   | NS  | SCREW                        | 86.9A552.3R0 |
|                                                                                   | NS  | SCREW                        | 86.9A552.4R0 |
|                                                                                   | NS  | SCREW                        | 86.9A553.3R0 |
|                                                                                   | NS  | SCREW                        | 86.9A553.4R0 |
|                                                                                   | NS  | SCREW                        | 34.00015.081 |
|                                                                                   | NS  | SCREW                        | 86.1A552.100 |
|                                                                                   | NS  | SCREW                        | 86.9A353.8R0 |

### Extensa 2500 FRU List

| Picture                                                                             | No. | Partname And Description                     | Part Number  |
|-------------------------------------------------------------------------------------|-----|----------------------------------------------|--------------|
| Adapter                                                                             |     |                                              |              |
|  |     | ADAPTER 135W 19V 3PIN<br>LITEON PA-1131-08AC | AP.13503.001 |
|                                                                                     |     | ADAPTER 135W 19V 3PIN<br>LISHIN 0317A19135   | TBD          |
|                                                                                     |     | ADAPTER 135W 19V 3PIN<br>HIPRO OW135F13      | TBD          |
| Battery                                                                             |     |                                              |              |
|  |     | RTC BATTERY                                  | 23.T30V1.001 |
|  | 18  | BATTERY MODULE LI-ON<br>8CELL SIMPLO         | 6M.A20V1.001 |
|                                                                                     |     | BATTERY MODULE LI-ON<br>12CELL SANYO         | TBD          |







## Extensa 2500 FRU List

| Picture                                                                             | No. | Partname And Description                              | Part Number  |
|-------------------------------------------------------------------------------------|-----|-------------------------------------------------------|--------------|
|    |     | BATTERY PACK LI-ON 8CELL<br>PANASONIC                 | BT.T3007.003 |
|                                                                                     |     | BATTERY LI-ON 8CELL SANYO                             | BT.T3003.001 |
|                                                                                     |     | BATTERY PACK LI-ON 12CELL<br>SANYO                    | TBD          |
| CASE/COVER/BRACKET ASSEMBLY                                                         |     |                                                       |              |
|    |     | BATTERY COVER                                         | 42.T30V1.001 |
| Boards                                                                              |     |                                                       |              |
|    |     | DC-DC CHARGER BOARD                                   | 55.T30V1.001 |
|   |     | WIRELESS LAN BOARD AMBIT<br>802.11B T60H656.02 REV.03 | 54.03096.022 |
|                                                                                     |     | WIRELESS LAN BOARD<br>802.11G WNC MIMIPCI             | 54.A16V1.001 |
|  |     | LAUNCH BOARD                                          | 55.T30V1.002 |
|  |     | MODEM BOARD AMBIT<br>T60M283.10(01)                   | 54.09011.544 |
|                                                                                     |     | MODEM/BLUETOOTH BOARD<br>AMBIT T60M665.00             | 54.09061.001 |
| Cables                                                                              |     |                                                       |              |
|  |     | COVER SWITCH CABLE                                    | TBD          |

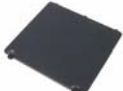
**Extensa 2500 FRU List**

| Picture                                                                             | No. | Partname And Description                                               | Part Number  |
|-------------------------------------------------------------------------------------|-----|------------------------------------------------------------------------|--------------|
|    |     | LAUNCH CABLE                                                           | 50.T30V1.011 |
|    |     | MODEM CABLE 2PIN<br>2CONNECTOR 55MM                                    | 50.41T11.002 |
|                                                                                     |     | POWER CORD US (3 pin)                                                  | 27.01618.051 |
| <b>Case/Cover/Bracket Assembly</b>                                                  |     |                                                                        |              |
|    | 6   | HINGE CAP RIGHT                                                        | TBD          |
|    | 8   | HINGE CAP LEFT                                                         | TBD          |
|  | 10  | OPTICAL DRIVE SUPPORT<br>BRACKET                                       | 33.T30V1.001 |
|  | 15  | HDD BRACKET                                                            | 33.A20V1.001 |
|  | 16  | HDD HOLDER                                                             | 33.T30V1.003 |
|                                                                                     | 17  | LOWER CASE W/DIMM<br>COVER& SPEAKER W/O MDC<br>COVER (USE FOR NON-FDD) | 60.T45V1.002 |
|  |     | MODEM COVER W/SCREW                                                    | 42.A20V1.001 |

### Extensa 2500 FRU List

| Picture                                                                             | No. | Partname And Description        | Part Number  |
|-------------------------------------------------------------------------------------|-----|---------------------------------|--------------|
|    |     | DIMM COVER W/SCREW              | TBD          |
|                                                                                     | 19  | UPPER CASE W/COVER SWITCH CABLE | TBD          |
|    |     | TOUCHPAD COVER                  | 42.T30V1.006 |
|    |     | 2ND FAN BRACKET                 | 33.A29V1.002 |
|                                                                                     |     | MIDDLE COVER W/LAUNCH BOARD     | TBD          |
| Communication Module                                                                |     |                                 |              |
|    |     | WIRELESS ANTENNA RIGHT (BLACK)  | 50.A20V1.001 |
|  |     | WIRELESS ANTENNA LEFT (GRAY)    | 50.A20V1.002 |
|                                                                                     |     | BLUETOOTH ANTENNA               | 50.A20V1.004 |
| CPU                                                                                 |     |                                 |              |
|  |     | CPU 2.8GMHZ 800FSB INTEL        | KC.DPP01.28C |
|                                                                                     |     | CPU 3.0GMHZ 800FSB INTEL        | KC.DPP01.30C |
|                                                                                     |     | CPU P4 2.8GMHZ 800FSB INTEL     | KC.DPD01.28B |
|                                                                                     |     | CPU 2.8GMHZ 400FSB INTEL        | KC.DCD01.28A |
|                                                                                     |     | CPU P4 2.6GMHZ 400FSB INTEL     | KC.DPD01.26A |
|                                                                                     |     | CPU P4 3.0GMHZ 533 INTEL        | KC.DPD01.306 |
|                                                                                     |     | CPU P4 3.0GMHZ 800FSB INTEL     | KC.DP001.30C |

## Extensa 2500 FRU List

| Picture                                                                             | No. | Partname And Description              | Part Number  |
|-------------------------------------------------------------------------------------|-----|---------------------------------------|--------------|
|                                                                                     |     | CPU P4 3.2GMHZ 800FSB<br>INTEL        | KC.DP001.32C |
|                                                                                     |     | CPU 3.2GMHZ 800FSB INTEL              | KC.DPP01.32C |
|                                                                                     |     | CPU 3.4GMHZ 800FSB INTEL              | KC.DPP01.34C |
|    |     | FAN 2ND                               | 23.T45V1.001 |
| FDD/Floppy Disk Drive                                                               |     |                                       |              |
|    | 13  | FDD MODULE 1.44M MCI JU-226A033FC     | 6M.T45V1.004 |
|                                                                                     |     | FDD MODULE 1.44M MITSUMI D353G 4515   | 6M.T45V1.005 |
|    |     | FDD MODULE 1.44M PANASONIC JU-226A033 | KF.T3007.001 |
|                                                                                     |     | FDD MODULE 1.44M MITSUMI D353G 4515   | KF.T3006.001 |
|  |     | FDD BRACKET                           | 33.T30V1.005 |
|  |     | FDD CABLE                             | 50.T30V1.003 |
| HDD/ Hard Disk Drive                                                                |     |                                       |              |
|  |     | HDD 20G HITACHI IC25N020ATMR04        | KH.02007.006 |
|                                                                                     |     | HDD 30GB HITACHI IC25N030ATMR04       | KH.03007.005 |
|                                                                                     |     | HDD 30GB FUJITSU MHT2030AT 009B A3    | KH.03006.004 |
|                                                                                     |     | HDD 30GB SEAGATE ST93015A 4.05        | KH.03001.001 |







## Extensa 2500 FRU List

| Picture                                                                             | No. | Partname And Description              | Part Number  |
|-------------------------------------------------------------------------------------|-----|---------------------------------------|--------------|
|                                                                                     |     | HDD 30G TOSHIBA<br>MK3021GAS          | KH.33004.001 |
|                                                                                     |     | HDD 40GB HITACHI<br>IC25N040ATMR04    | KH.04007.009 |
|                                                                                     |     | HDD 40G TOSHIBA<br>MK4025GAS          | KH.04004.002 |
|                                                                                     |     | HDD 40GB FUJITSU<br>MHT2040AT 0022 A3 | KH.04006.004 |
|                                                                                     |     | HDD 40G SEAGATE ST94019A              | KH.04001.010 |
|                                                                                     |     | HDD 60GB HITACHI<br>IC25N060ATMR04    | KH.06007.006 |
|                                                                                     |     | HDD 60GB HITACHI DK23FA-60<br>A0A0    | KH.06007.005 |
|                                                                                     |     | HDD 60G TOSHIBA<br>MK6021GAS          | KH.36004.001 |
|                                                                                     |     | HDD 60G HITACHI DK23FA-60<br>A0A0     | KH.06007.005 |
|                                                                                     |     | HDD 60G TOSHIBA<br>MK6021GAS          | KH.36004.001 |
|                                                                                     |     | HDD 80G HITACHI<br>IC25N080ATMR04     | KH.08007.002 |
|                                                                                     |     | HDD 80GB TOSHIBA<br>MK8025GAS KA023A  | KH.08004.001 |
| <b>Heatsink</b>                                                                     |     |                                       |              |
|  | 4   | CPU FANSINK                           | 34.T45V1.003 |
|  | 4   | CPU THERMAL PLATE                     | 34.A20V1.001 |
|                                                                                     |     | VGA THERMAL PLATE                     | 34.T45V1.001 |
|  |     | VGA THERMAL PLATE                     | 33.A20V1.003 |
| <b>Keyboard</b>                                                                     |     |                                       |              |
|  | 2   | KEYBOARD DARFON NSK-<br>ACY0G GERMANY | KB.A1907.001 |
|                                                                                     |     | KEYBOARD DARFON NSK-<br>ACY1D USI     | KB.T3007.047 |
|                                                                                     |     | KEYBOARD DARFON NSK-<br>ACY0U UK      | KB.T3007.052 |
|                                                                                     |     | KEYBOARD DARFON NSK-<br>ACY0J JPN     |              |

## Extensa 2500 FRU List

| Picture                                                                             | No. | Partname And Description               | Part Number  |
|-------------------------------------------------------------------------------------|-----|----------------------------------------|--------------|
|                                                                                     |     | KEYBOARD DARFON NSK-ACY06 PORTUGUE     | KB.A2007.004 |
|                                                                                     |     | KEYBOARD DARFON NSK-ACY0A ARABIC       | KB.A2007.005 |
|                                                                                     |     | KEYBOARD DARFON NSK-ACY1A BELGIAN      | KB.A2007.006 |
|                                                                                     |     | KEYBOARD DARFON NSK-ACY0W SWEDISH      | KB.A2007.007 |
|                                                                                     |     | KEYBOARD DARFON NSK-ACY0C CZECH        | KB.A2007.008 |
|                                                                                     |     | KEYBOARD DARFON NSK-ACY0Q HUNGARIAN    | KB.A2007.009 |
|                                                                                     |     | KEYBOARD DARFON NSK-ACY0N NORWAY       | KB.A2007.010 |
|                                                                                     |     | KEYBOARD DARFON NSK-ACY0D DANISH       | KB.A2007.011 |
|                                                                                     |     | KEYBOARD DARFON NSK-ACY0T TURKISH      | KB.A2007.012 |
|                                                                                     |     | KEYBOARD DARFON NSK-ACY0M FRE/CAN      | KB.A2007.013 |
|                                                                                     |     | KEYBOARD DARFON NSK-ACY0L GREEK        | KB.A2007.014 |
|                                                                                     |     | KEYBOARD DARFON NSK-ACY0R RUSSIAN      | KB.A2007.015 |
|                                                                                     |     | KEYBOARD DARFON NSK-ACY02 TAIWAN       | KB.A2007.016 |
|                                                                                     |     | KEYBOARD DARFON NSK-ACY0S SPANISH      | KB.A2007.017 |
|                                                                                     |     | KEYBOARD DARFON NSK-ACY03 THAILAND     | KB.A2007.018 |
|                                                                                     |     | KEYBOARD DARFON NSK-ACY1B BRAZILIAN    | KB.A2007.019 |
|                                                                                     |     | KEYBOARD DARFON NSK-ACY0E ITALY        | KB.A2007.021 |
|                                                                                     |     | KEYBOARD DARFON NSK-ACY0F FRENCH       | KB.A2007.022 |
|                                                                                     |     | KEYBOARD DARFON NSK-ACY0K KOREAN       | KB.A2007.023 |
|                                                                                     |     | KEYBOARD DARFON NSK-ACY00 SWISS        | KB.A2007.024 |
| LCD                                                                                 |     |                                        |              |
|  |     | LCD 14.1" TFT XGA AU B141XN04 V2/5AXXX | LK.14105.005 |
|                                                                                     |     | LCD 15" XGA TFT CHIMEI N150X3-L05 C2   | LK.1500D.004 |
|                                                                                     |     | LCD 15" XGA TFT QDI QD15XL06-01        | LK.15009.002 |
|                                                                                     |     | LCD 15" XGA LG LP150X08-A5             | LK.15008.012 |

### Extensa 2500 FRU List

| Picture                                                                             | No. | Partname And Description    | Part Number  |
|-------------------------------------------------------------------------------------|-----|-----------------------------|--------------|
|    |     | INVERTER BOARD 15" SUMIDA   | 19.T30V1.201 |
|                                                                                     |     | INVERTER BOARD 14"/15"      | 19.21030.171 |
|    |     | LCD BRACKET RIGHT FOR 14.1" | 33.T30V1.006 |
|                                                                                     |     | LCD BRACKET RIGHT FOR 15"   | 33.A16V1.002 |
|    | NS  | LCD BRACKET LEFT FOR 14.1"  | 33.T30V1.007 |
|                                                                                     |     | LCD BRACKET LEFT FOR 15"    | 33.A16V1.003 |
|    |     | INVERTER CABLE              | 50.T30V1.007 |
|   |     | LCD COAXIAL CABLE 14"       | 50.A20V1.003 |
|                                                                                     |     | LCD COAXIAL CABLE 15"       | 50.49V06.002 |
|  | NS  | LCD PANEL W/HINGE & LOGO    | TBD          |
|  | NS  | LCD BEZEL W/ICON PLATE      | TBD          |
|  |     | HINGE PACK                  | TBD          |
| Main Board                                                                          |     |                             |              |

## Extensa 2500 FRU List

| Picture                                                                             | No. | Partname And Description                                                  | Part Number  |
|-------------------------------------------------------------------------------------|-----|---------------------------------------------------------------------------|--------------|
|    |     | MAINBOARD W/O CPU W/<br>MODEM CABLE & LAUNCH<br>BOARD CABLE (USE FOR FDD) | TBD          |
|                                                                                     |     | MAINBOARD W/O CPU W/<br>MODEM CABLE & LAUNCH<br>BOARD CABLE               | LB.T4501.001 |
| Miscellaneous                                                                       |     |                                                                           |              |
|                                                                                     |     | LCD SCREW RUBBER                                                          | 47.T45V1.001 |
|                                                                                     |     | LCD SCREW RUBBER                                                          | 47.T45V1.002 |
|    |     | LOGO                                                                      | TBD          |
|                                                                                     |     | RUBBER FOOT                                                               | TBD          |
|    |     | TOUCHPAD KNOB                                                             | 42.T30V1.008 |
|   |     | ICON LABEL                                                                | 40.T30V1.001 |
|                                                                                     |     | NAME PLATE                                                                | 40.E01V1.001 |
| Memory                                                                              |     |                                                                           |              |
|  | NS  | SODIMM 128M INFINEON<br>HYS64D16000GDL-6-B                                | KN.12802.006 |
|                                                                                     |     | SODIMM 256M INFINEON<br>HYS64D32020GDL-6-B                                | KN.25602.009 |
|                                                                                     |     | SODIMM256M NANYA<br>NT256D64SH8BAGM-6KE                                   | KN.25603.014 |
|                                                                                     |     | SODIMM256M MICRON 256M<br>MT8VDDT3264HDG-335                              | KN.25604.009 |
|                                                                                     |     | SODIMM 512M INFINEON<br>HYS64D64020GBDL-6-B                               | KN.51202.007 |
|                                                                                     |     | SODIMM 512M NANYA<br>NT512D64S8HBAFM-6K                                   | KN.51203.005 |
| Optical Drive                                                                       |     |                                                                           |              |
|  |     | CD-ROM MODULE 24X QSI<br>SCR-242                                          | 6M.T45V1.001 |

## Extensa 2500 FRU List

| Picture                                                                             | No. | Partname And Description                | Part Number  |
|-------------------------------------------------------------------------------------|-----|-----------------------------------------|--------------|
|                                                                                     |     | COMBO MODULE 24X QSI SBW-242B           | 6M.A20V1.003 |
|                                                                                     |     | DVD-ROM MODULE 8X MKE SR-8177           | 6M.T46V1.001 |
|                                                                                     |     | DVD-RW MODULE 2X UJ-820B-A DVR-K12D     | 6M.A20V1.004 |
|                                                                                     |     | DVD-RW MODULE DRIVE 2X PIONEER DVR-K12D | 6M.A20V1.005 |
|    |     | CD-ROM DRIVE 24X QSI SCR-242            | 56.10291.021 |
|                                                                                     |     | CD-ROM DRIVE 24X QSI SCR-242B           | KO.02407.012 |
|                                                                                     |     | DVD-ROM 8X MKE SR-8177                  | KV.08X02.004 |
|                                                                                     |     | DVD-RW DRIVE 2X UJ-820B-A DVR-K12D      | TBD          |
|                                                                                     |     | DVD-RW DRIVE 2X PIONEER DVR-K12D        | KU.00405.004 |
|   |     | OPTICAL DRIVE BRACKET                   | 33.T30V1.004 |
| PCMCIA slot/PC card slot                                                            |     |                                         |              |
|                                                                                     |     | PCMCIA SLOT                             | 22.T30V1.001 |
| Pointing Device                                                                     |     |                                         |              |
|  | NS  | TOUCHPAD SYNAPTICS TM41P-357            | 56.17001.001 |
|                                                                                     |     | SPEAKER                                 | TBD          |
| Screws                                                                              |     |                                         |              |
|                                                                                     | NS  | SCREW                                   | 86.T30V1.001 |
|                                                                                     | NS  | SCREW                                   | 86.9A352.3R0 |
|                                                                                     | NS  | SCREW                                   | 86.9A353.6R0 |
|                                                                                     | NS  | SCREW                                   | 86.9A524.4R0 |
|                                                                                     | NS  | SCREW                                   | 86.9A552.2R0 |
|                                                                                     | NS  | SCREW                                   | 86.9A552.3R0 |
|                                                                                     | NS  | SCREW                                   | 86.9A552.4R0 |
|                                                                                     | NS  | SCREW                                   | 86.9A553.3R0 |
|                                                                                     | NS  | SCREW                                   | 86.9A553.4R0 |
|                                                                                     | NS  | SCREW                                   | 34.00015.081 |
|                                                                                     | NS  | SCREW                                   | 86.1A552.100 |
|                                                                                     | NS  | SCREW                                   | 86.9A353.8R0 |



## Model Definition and Configuration

### Model Name Definition

#### Extensa 2000

| Model Number | LCD          | CPU        | Memory            | HDD  | ODD         | Battery | Wireless LAN |
|--------------|--------------|------------|-------------------|------|-------------|---------|--------------|
| 2001LC       | 15.0"<br>XGA | ICP 2.6GHz | DDR333<br>1x256MB | 40GB | 24x Combo   | Li-Ion  | N            |
| 2001LM       | 15.0"<br>XGA | ICP 2.6GHz | DDR333<br>1x256MB | 40GB | 4x DVD-Dual | Li-Ion  | N            |
|              |              |            |                   |      |             |         |              |
|              |              |            |                   |      |             |         |              |
|              |              |            |                   |      |             |         |              |
|              |              |            |                   |      |             |         |              |
|              |              |            |                   |      |             |         |              |

#### Extensa 2500

| Model Number         | LCD          | CPU             | Memory            | HDD  | CD/DVD      | Battery | Wireless LAN |
|----------------------|--------------|-----------------|-------------------|------|-------------|---------|--------------|
| 2501LC               | 15.0"<br>XGA | DT P4<br>2.8GHz | DDR333<br>1x256MB | 40GB | 24x Combo   | Li-Ion  | N            |
| 2501LM               | 15.0"<br>XGA | DT P4<br>2.8GHz | DDR333<br>1x256MB | 40GB | 4x DVD-Dual | Li-Ion  | N            |
| 2501FLC<br>(IBM DOS) | 15.0"<br>XGA | DT P4<br>2.8GHz | DDR333<br>1x256MB | 40GB | 24x Combo   | Li-Ion  | N            |
| 2501FLM<br>(IBM DOS) | 15.0"<br>XGA | DT P4<br>2.8GHz | DDR333<br>1x256MB | 40GB | 4x DVD-Dual | Li-Ion  | N            |
|                      |              |                 |                   |      |             |         |              |
|                      |              |                 |                   |      |             |         |              |
|                      |              |                 |                   |      |             |         |              |
|                      |              |                 |                   |      |             |         |              |
|                      |              |                 |                   |      |             |         |              |





## ***Test Compatible Components***

---

This computer's compatibility is a test plan released by Acer Internal Testing Department. Once the final report is available, this chapter will be revised accordingly.

# Microsoft® Windows® XP Environment Test

| Item             | Specifications                                                                                                                                                                                                                                                                                                                                                                                                                                                                                             |
|------------------|------------------------------------------------------------------------------------------------------------------------------------------------------------------------------------------------------------------------------------------------------------------------------------------------------------------------------------------------------------------------------------------------------------------------------------------------------------------------------------------------------------|
| Processor        | Intel Celeron 2.6GHz/400FSB/128K<br>Intel Pentium 4 2.8GMHZ 533FSB                                                                                                                                                                                                                                                                                                                                                                                                                                         |
| Memory           | 128MB Infineon SO-DIMM HYS64D16000GDL-6-B<br>256MB Infineon SO-DIMM HYS64D32020GDL-6-B<br>256MB Nanya SO-DIMM NT256D64SH8BAGM-6KE (.14u)<br>256MB Micron SO-DIMM MT8VDDT3264HDG-335C3 (.13u)<br>256MB Samsung SO-DIMM M470L3224FT0-CB3<br>512MB Infineon SO-DIMM HYS64D64020GBDL-6-B<br>512MB Nanya SO-DIMM NT512D64S8HBAFM-6K (.14u)<br>1GB Elpedia SO-DIMM EBD11UD8ADDA                                                                                                                                  |
| LCD              | 14.1" XGA TFT<br>AU B141XN04 V.2 (AU) Driver IC: 5Axxx<br>CMO N141XB-L01 (SPWG-B type)<br>TOPPLY TD141TGCB1<br>HYDIS HT14X19-100 (SPWG-B type)<br>15" XGA TFT<br>AU B150XG01<br>HITACHI TFT-LCD TX38D81VC1CAB Rev. B<br>CMO TFT-LCD N150X3-L05 Rev.C<br>LG LP150X08-A5<br>QDI QD15XL06-01<br>SAMSUNG LTN150XB-L03 /6xxx<br>HANNSTAR 150PX14 - A07<br>15" SXGA+ TFT<br>AU B150PG01<br>HANNSTAR 150PK14 - A02<br>LG LP150E06-B3K1                                                                            |
| Hard Disk Drive  | 20G HGST Moraga IC25N020ATMR04 f/w:AD4A<br>20GB Toshiba Neptune MK2023GAP<br><br>30GB HGST Moraga IC25N030ATMR04 f/w:AD4<br>30G Fujitsu Fujitsu V-40 MHT2030AT<br>30G Seagate N1 ST93015A, 2M<br><br>40GB HGST Moraga IC25N040ATMR04-0, f/w:AD4A<br>40G Fujitsu V40+ MHT2040AT<br>40G Seagate N1 ST94019A, 2M<br><br>60G HGST Moraga IC25N060ATMR04-0 f/w:AD4A<br>60G HGST Fresno DK23FA-60 HT S428060F9AT00<br>60G TOSHIBA Neptune MK6021GAS<br><br>80G HGST Moraga IC25N080ATMR04<br>80G Pluto MK8025GAS |
| DVD-ROM Drive 8X | MKE SR-8177                                                                                                                                                                                                                                                                                                                                                                                                                                                                                                |
| CD-ROM Drive 24X | Mitsumi SR-224W1<br>QSI SCR242                                                                                                                                                                                                                                                                                                                                                                                                                                                                             |
| DVD/CD-RW Combo  | KME UJDA750<br>QSI SBW-242B                                                                                                                                                                                                                                                                                                                                                                                                                                                                                |

| Item                                    | Specifications                                                                                                                                                                                |
|-----------------------------------------|-----------------------------------------------------------------------------------------------------------------------------------------------------------------------------------------------|
| DVD-dual                                | DVD-Dual SDW-042<br>DVD-Dual SDW-431S<br>DVD-Dual GWA-4040N<br>DVD-Dual DVR K13RA                                                                                                             |
| DVD-RW                                  | DVD-RW SD-R6112                                                                                                                                                                               |
| DVD-Super Multi                         | UJ820 DVD super multi                                                                                                                                                                         |
| AC Adapter (3 pin)                      | Liteon Adapter 135W<br>ADT 135W 3P 19V 0317A19135<br>HiPro Adapter 135W                                                                                                                       |
| Power Cord                              | King Cord                                                                                                                                                                                     |
| Battery Li-Ion, 8 cells                 | SANYO BTP-60A1<br>SIMPLO BTY PK Panasonic                                                                                                                                                     |
| Network Adapters                        |                                                                                                                                                                                               |
| LAN Ethernet/10baseT/100baseT           | 3Com Etherlink III 3C589D<br>IBM EtherJet CardBus Adapter 10/100<br>Intel Ether Express Pro/100 Mobile Adapter MBLA3200<br>Xircom CardBus Ethernet 10/100 32 Bit CBE-10/100BTX                |
| Multifunction Card (Combo)              | 3Com Megahertz 10/100 LAN + 56K Modem PC Card<br>Xircom RealPort CardBus Ethernet 10/100 + Modem 56                                                                                           |
| LAN Token Ring                          | IBM Token Ring 16/4 Adapter II                                                                                                                                                                |
| Wireless LAN Card                       | IBM Wireless LAN Cardbus Adapter<br>Intel Pro-Wireless LAN PC Card<br>Proxim Skyline 802.11a Cardbus PC Card<br>Cisco Aironet 350 series Wireless Lan Card<br>NeWeb Wireless Lan Card 802.11b |
| Modem Adapters                          |                                                                                                                                                                                               |
| Modem (up to 56K)                       | 3Com Megahertz 56K Modem PC Card<br>Xircom Credit Card Modem 56<br>IBM 56K Double Jack Modem                                                                                                  |
| ISDN                                    | US Robotics Megahertz 128K ISDN Card 405R17T7117M<br>IBM OBI International ISDN PC Card                                                                                                       |
| I/O Peripheral                          |                                                                                                                                                                                               |
| I/O - Display                           | Acer 211c 21"<br>Viewsonic PF790 19"<br>Acer FP751 17" TFT LCD<br>IBM Color TFT LCD 14"<br>Compaq Color Monitor<br>NET Color Monitor 20"<br>Mozo 17" TFT LCD (DVI)                            |
| I/O - Projector                         | NEC MultiSync MT-1040                                                                                                                                                                         |
| I/O - Legacy (Parallel) Printer/Scanner | Canon BJC-600J<br>Epson Stylus Color 740 Parallel Interface<br>HP DeskJet 890C<br>HP DeskJet 880C Parallel Interface<br>HP LaserJet 6MP<br>HP LaserJet 2200                                   |
| I/O - IR Printer                        | HP LaserJet 6MP use IR<br>HP LaserJet 2200 use IR                                                                                                                                             |

| Item                                     | Specifications                                                                                                                                                                                                                                                                                                                                                                                                    |
|------------------------------------------|-------------------------------------------------------------------------------------------------------------------------------------------------------------------------------------------------------------------------------------------------------------------------------------------------------------------------------------------------------------------------------------------------------------------|
| I/O - USB Keyboard/Mouse                 | Chicony USB Keyboard KU-8933<br>Microsoft Natural Keyboard Pro<br>Acer Aspire USB mouse<br>Logicoool US Mouse<br>Logitech Cordless Mouseman Wheel USB Interface<br>Logitech USB Wheel Mouse M-BB48<br>Microsoft IntelliMouse Optical USB Interface                                                                                                                                                                |
| I/O - Legacy (PS2/Serial) Keyboard/Mouse | IBM 101 key keyboard<br>IBM 109 key keyboard<br>Acer PS2 keyboard<br>Acer KB-101A<br>IBM Numeric Keypad III<br>IBM Numeric Keypad<br>Acer Mouse<br>IBM PS2 Mini Mouse<br>IBM PS2 Mouse<br>Logitech Cordless MouseMan Wheel PS2 interface<br>Logitech Serial Mouse M-M35<br>Microsoft IntelliMouse PS2 interface<br>Microsoft IntelliMouse Optical PS2 interface<br>Logitech First Mouse Three Button Serial Mouse |
| I/O - USB (Printer/Scanner)              | Epson Stylus Color 740 USB interface<br>HP DeskJet 880C USB interface<br>Canon CanonScan D1250 (USB 2.0, JP OS only)<br>HP ScanJet 3300C Color Scanner                                                                                                                                                                                                                                                            |
| I/O - USB (Speaker/Joystick))            | JS USB Digital Speaker<br>Panasonic USB Speaker EAB-MPC57USB<br>AIWA Multimedia Digital Speaker<br>Microsoft SideWinder Precision Pro Joystick<br>Logitech WingMan RumblePad                                                                                                                                                                                                                                      |
| I/O - USB Camera                         | Intel Easy PC Camera<br>Logitech QuickCam Express Internet<br>Logitech QuickCam Home PC Video Camera<br>Orange Micro USB 2.0 Web Cam                                                                                                                                                                                                                                                                              |
| I/O - USB Storage Drive                  | Logitech CDRW +DVDROM combo USB interface<br>Iomega USB Zip 250MB                                                                                                                                                                                                                                                                                                                                                 |
| I/O-USB Flash Drive                      | IBM 32MB USB Memory key<br>Apacer USB Handy Drive 32MB<br>Apacer USB Handy Drive 256MB                                                                                                                                                                                                                                                                                                                            |
| I/O - USB Hub                            | Belkin 4 Port USB Hub<br>Eizo I Station USB Hub<br>Elecom USB Hub 4 Port<br>Sanwa USB Hub 4 Port<br>4 Port Hub USB 2.0                                                                                                                                                                                                                                                                                            |
| I/O - Access Point (802.11b)             | Hitachi DC-CN3300<br>Lucent RG-1000<br>Lucent WavePoint-II<br>Cisco Aironet 350<br>Orinoco AP-500                                                                                                                                                                                                                                                                                                                 |
| I/O Access Point (802.11a/b)             | Intel Dual Pro/Wireless 5000                                                                                                                                                                                                                                                                                                                                                                                      |
| I/O Access Point (802.11a)               | Intel Pro/Wireless 5000                                                                                                                                                                                                                                                                                                                                                                                           |

| Item               | Specifications                                                                                                                                                                                                                                                           |
|--------------------|--------------------------------------------------------------------------------------------------------------------------------------------------------------------------------------------------------------------------------------------------------------------------|
| PCMCIA             |                                                                                                                                                                                                                                                                          |
| PCMCIA - ATA       | IBM Microdrive 340MB<br>IBM Microdrive 1G<br>Iomega Click! 40MB<br>Sony Memory Stick 64MB<br>Sandisk Flash Card 20MB<br>Apacer SD Flash Card 128MB<br>Apacer SD Flash Card 256MB<br>Transcend SD Card 32MB<br>Transcend SD Card 256MB<br>Hagiwara sys-com SD Card 256MBT |
| PCMCIA - USB 2.0   | Apricorn EZ-USB2.0 Cardbus PC Card<br>DTK USB 2.0 2Port CardBus Host Controller<br>Adaptec USB2CONNECT                                                                                                                                                                   |
| PCMCIA - 1394      | Buffalo 1394 Interface Cardbus IFC-ILCB/DV<br>I-O Data 1394 Interface Cardbus CB1394/DVC<br>Pixela 1394 Cardbus PC Card PIX-PCMC/FW1                                                                                                                                     |
| PCMCIA-SCSI        | Adaptec 1408 or B SCSI CB<br>NewMedia Bus Toaster SCSI II                                                                                                                                                                                                                |
| PCMCIA - Bluetooth | IBM Community Bluetooth PC Card<br>Toshiba Bluetooth PC Card                                                                                                                                                                                                             |



## Online Support Information

---

This section describes online technical support services available to help you repair your Acer Systems.

If you are a distributor, dealer, ASP or TPM, please refer your technical queries to your local Acer branch office. Acer Branch Offices and Regional Business Units may access our website. However some information sources will require a user i.d. and password. These can be obtained directly from Acer CSD Taiwan.

Acer's Website offers you convenient and valuable support resources whenever you need them.

In the Technical Information section you can download information on all of Acer's Notebook, Desktop and Server models including:

- Service guides
- User's manuals
- Training materials
- Main manuals
- Bios updates
- Software utilities
- Spare parts lists
- Chips
- TABs (Technical Announcement Bulletin)

For these purposes, we have included an Acrobat File to facilitate the problem-free downloading of our technical material.

Also contained on this website are:

- Detailed information on Acer's International Traveller's Warranty (ITW)
- Returned material authorization procedures
- An overview of all the support services we offer, accompanied by a list of telephone, fax and email contacts for all your technical queries.

We are always looking for ways to optimize and improve our services, so if you have any suggestions or comments, please do not hesitate to communicate these to us.





**A**

- AC Adapter 28
- AFLASH Utility 49
- Audio 18

**B**

- Battery 27
- battery pack
  - charging indicator 11
- BIOS 18
  - package 18
  - ROM size 18
  - ROM type 18
  - vendor 18
  - Version 18
- BIOS Setup Utility 36
- BIOS Supports protocol 18
- BIOS Utility 36°???
- Basic System Settings 41
- Navigating 37
- Onboard Device Configuration 44
- Startup Configuration 43
- System Information 37
- System Security 48
- Board Layout
  - Bottom View 5, 106
  - Top View 4, 105
- brightness
  - hotkeys 15

**C**

- Cache
  - controller 18
  - size 19
- caps lock
  - on indicator 11
- CardBus 26
- CD-ROM Interface 21
- Chipsets 18
- computer
  - on indicator 11, 12
- contrast
  - hotkeys 15
- Controllers 18
- Core logic 18
- CPU
  - core voltage 18
  - I/O voltage 18
  - package 18

- type 18

**D**

- DC-AC LCD Inverter 28
- DC-DC/Charger 27
- DIMM 19
  - Combinations 19
  - package 19
  - Speed 19
  - voltage 19
- Disassembly Flowchart 52
- Display 1
- display
  - hotkeys 15
- Display Standby Mode 30
- DMA Channel Assignment 33
- DVD-ROM Interface 22

**E**

- Environmental Requirements 30
- Error Symptom-to-Spare Part Index 83
- External CD-ROM Drive Check 79

**F**

- Features 1
- Flash Utility 49
- Floppy Disk Drive Interface 20
- FRU (Field Replaceable Unit) List 108

**H**

- Hard disk 18, 20
- Hard Disk Drive Module
  - Disassembly 57
- Hard Disk Standby Mode 30
- Hardware Specifications and Configurations 18
- HDD 18, 20
- Hibernation Mode 30
- Hibernation mode
  - hotkey 15
- Hot Keys 15

**I**

- I/O Address Map 31
- Indicators 11
- Intermittent Problems 94
- IRQ Assignment Map 33

**J**

---

Jumper and Connector Locations  
SW2 Settings 106

## K

Keyboard 18, 27  
Keyboard or Auxiliary Input Device Check 79

## L

L2 cache 18  
LCD 28

## M

Mechanical Specification 30  
media access  
    on indicator 11  
Memory  
    Address Map 31  
Memory Address Map 31  
Memory Check 80  
Modem 20

## N

Notebook Manager  
    hotkey 15  
num lock  
    on indicator 11

## O

Online Support Information 138

## P

Panel 5, 106  
    Bottom 10  
Parallel Port 26  
PC Card 11, 26  
PCMCIA 26  
Power Management 29  
Power System Check 80  
    Battery Pack 82  
    Power Adapter 81  
Processor 18

## R

Removing the Battery Pack 54  
RTC 18

## S

Second Level Cache 18  
speakers  
    hotkey 15

Standby Mode 29  
Super I/O 18  
System Check Procedures 79  
System Memory 19  
System Utilities 36

## T

Temperature 30  
Test Compatible Components 132  
Touchpad 18  
touchpad  
    hotkey 15  
Touchpad Check 82  
Troubleshooting 78

## U

Undetermined Problems 95  
USB 26  
utility  
    BIOS 36

## V

Video 25, 26  
    Resolutions 26  
Video controller 18

## W

Windows® XP Environment Test 133

