

## FRU (Field Replaceable Unit) List

---

This chapter gives you the FRU (Field Replaceable Unit) listing in global configurations of TravelMate 4000/4500 series products. Refer to this chapter whenever ordering for parts to repair or for RMA (Return Merchandise Authorization).



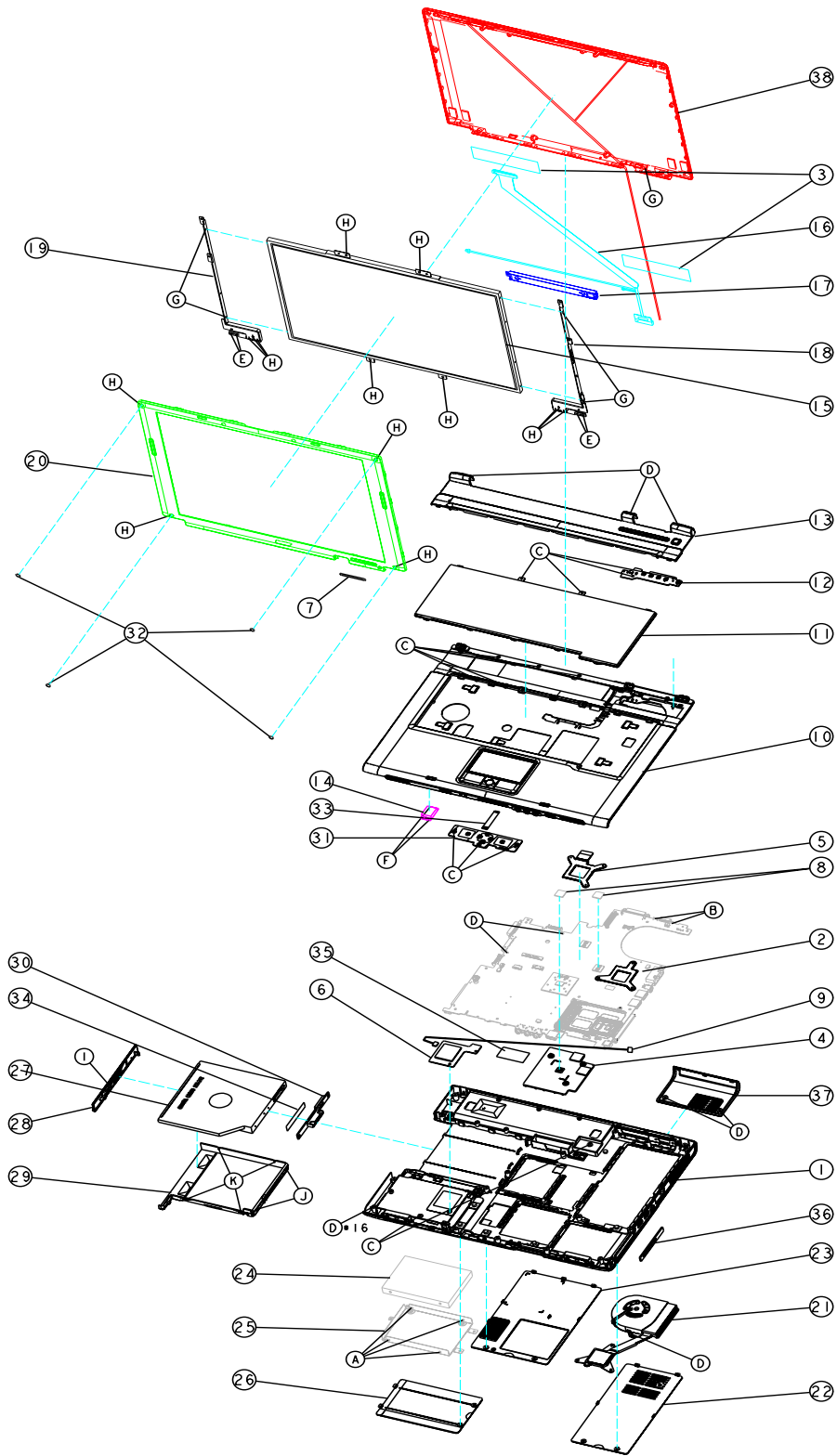

Please note that WHEN ORDERING FRU PARTS, you should check the most up-to-date information available on your regional web or channel. For whatever reasons a part number change is made, it will not be noted on the printed Service Guide. For ACER AUTHORIZED SERVICE PROVIDERS, your Acer office may have a DIFFERENT part number code from those given in the FRU list of this printed Service Guide. You MUST use the local FRU list provided by your regional Acer office to order FRU parts for repair and service of customer machines.

**NOTE:** To scrap or to return the defective parts, you should follow the local government ordinance or regulations on how to dispose it properly, or follow the rules set by your regional Acer office on how to return it.

# Exploded Diagram





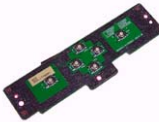



## TravelMate 4000

Picture	No.	Partname And Description	Part Number
<b>Adapter</b>			
		ADAPTER 65W 3 PIN DELTA SADP-65KB BF 19V	TBD
		ADAPTER 65W 3 PIN LITE-ON PA-1650-02 QA 19V	TBD
		ADAPTER 65W 3 PIN LI-SHIN SLS0335A 19V	TBD
<b>Battery</b>			
		BATTERY SANYO LI-ION 4S2P 4.4A 4UR18650F-2-QC140	TBD
		BATTERY PANASONIC LI-ION 4S2P 4.4A CGR-B/8B5AE	TBD
		BATTERY SIMPLO LI-ION 4S2P 4.4A 916-3020	TBD
<b>Boards</b>			
		MODEM BOARD	54.T50V7.001
		BLUETOOTH MODULE W/ANTENNA	54.T48V7.001
		WIRELESS LAN BOARD (802.11b+g) INTEL	KI.CAX01.005
		LAUNCH BOARD	55.T50V7.001
		TOUCH PAD BOARD	55.T50V7.002

## TravelMate 4000

Picture	No.	Partname And Description	Part Number
<b>Cables</b>			
		FFC CABLE - TP/B TO MB	50.T50V7.001
		MODEM CABLE	50.T50V7.002
		POWER CORD US (3 PIN)	27.A03V7.001
		POWER CORD PRC (3 PIN)	27.A03V7.003
		POWER CORD KOERA ( Pin)	27.T23V7.006
		POWER CORD EU (3 PIN)	27.A03V7.002
		POWER CORD UK (3 PIN)	27.A03V7.004
		POWER CORD ITALIAN (3 PIN)	27.A03V7.005
		POWER CORD- SWISS	27.A03V7.007
		POWER CORD AU (3 PIN)	27.A03V7.008
		POWER CORD DANISH (3 PIN)	27.A03V7.006
		POWER CORD AF (3 PIN)	27.T48V7.001
<b>Case/Cover/Bracket Assembly</b>			
		MIDDEL COVER ERGO W/BUTTON	42.T50V7.001
		UPPER CASE ERGO W/TP, TP BRACKET, TP TO TP BOARD FFC CABLE	60.T50V7.001
		LOWER CASE W/SPEAKER	60.T51V7.001
		I/O BEZEL	42.T51V7.001
		DIMM/WIRELESS COVER	42.T50V7.002

## TravelMate 4000

Picture	No.	Partname And Description	Part Number
		HEATSINK COVER	42.T50V7.003
		HDD COVER	42.T50V7.004
		3 IN 1 DUMMY COVER	42.T51V7.002
		HDD BRACKET	33.T50V7.001
<b>Communication Module</b>			
		WIRELESS LAN ANTENNA	50.T50V7.003
<b>CPU</b>			
		INTEL PENTIUM M 1.5G 2M 400FSB uFCPGA2 SL6F9 B-1 STEPPING	KC.N0001.715
		INTEL PENTIUM M 1.6G 2M 400FSB uFCPGA2 SL7EG B-1 STEPPING	KC.N0001.725
		INTEL PENTIUM M 1.7G 2M 400FSB uFCPGA2 SL7EP B-1 STEPPING	KC.N0001.735
		INTEL PENTIUM M 1.8G 2M 400FSB uFCPGA2 SL7EN B-1 STEPPING	KC.N0001.745
		INTEL PENTIUM M 2.0G 2M 400FSB uFCPGA2 SL7EM B-1 STEPPING	KC.N0001.755
<b>DVD Module</b>			
		DVD-ROM MODULE 8X QSI SDR-083	6M.T51V7.008
		DVD-ROM DRIVE 8X QSI SDR-083	KV.00803.003
		OPTICAL DEVICE HOLDER-FIX	42.T51V7.003
		DVD-ROM BEZEL FOR QSI	42.T51V7.004
<b>Combo Module</b>			



**TravelMate 4000**

Picture	No.	Partname And Description	Part Number
		DVD/CDRW COMBO MODULE 24X QSI SBW-242C	6M.T51V7.001
		DVD/CDRW COMBO DRIVE 24X QSI SBW-242C	KO.02407.014
		OPTICAL DEVICE HOLDER-FIX	42.T51V7.003
		DVD/CDRW BEZEL FOR QSI	42.T50V7.008
		DVD/CDRW COMBO MODULE KME UIDA-760	6M.T51V7.002
		DVD/CDRW COMBO DRIVE 24X KME UIDA-760	KO.02406.008
		OPTICAL DEVICE HOLDER-FIX	42.T51V7.003
		DVD/CDRW BEZEL FOR KME	42.T50V7.009
		DVD DUAL MODULE QSI SDW-042	6M.T51V7.003
		DVD DUAL DRIVE QSI SDW-042	KU.00403.001
		OPTICAL DEVICE HOLDER-FIX	42.T51V7.003
		DVD DUAL BEZEL FOR QSI	42.T50V7.010
		DVD DUAL MODULE PIONEER DVR-K14RA	6M.T51V7.004
		DVD DUAL DRIVE PIONEER DVR-K14RA	KU.00805.001
		OPTICAL DEVICE HOLDER-FIX	42.T51V7.003
		DVD DUAL BEZEL FOR PIONEER	42.T50V7.011
		DVD DUAL MODULE LITE-ON SOSW-852S	6M.T51V7.005
		DVD DUAL DRIVE LITE-ON SOSW-852S	KU.00805.001
		OPTICAL DEVICE HOLDER-FIX	42.T51V7.003
		DVD DUAL BEZEL FOR LITE-ON	42.T50V7.012
		DVD SUPER MULTI MODULE KME UJ-830B	6M.T51V7.006
		DVD SUPER MULTI DRIVE KME UJ-830B	KU.00807.003

## TravelMate 4000



Picture	No.	Partname And Description	Part Number
		OPTICAL DEVICE HOLDER-FIX	42.T51V7.003
		DVD SUPER MULTI BEZEL FOR KME	42.T50V7.013
		DVD SUPER MULTI MODULE HLDS GSA-4080N	6M.T51V7.007
		DVD SUPER MULTI DRIVE HLDS GSA-4080N	TBD
		OPTICAL DEVICE HOLDER-FIX	42.T51V7.003
		DVD SUPER MULTI BEZEL FOR HLDS	42.T50V7.014
HDD/Hard Disk Drive			
		30G HGST 2.5" 4200 Moraga+ HTS424030M9AT00 13G1486 fw:DA1017	KH.03007.006
		Toshiba Pluto 30G 4200rpm MK3025GAS	KH.03004.002
		Seagate 30G ST93015A,2MB F/W:4.05	KH.03001.001
		40G HGST 2.5" 4200 Moraga+ HTS424040M9AT00 13G1132 fw:DA1017	KH.04007.010
		Toshiba PLUTO 40G 4200rpm MK4025GAS ,KA100A F/W:KA100A	KH.04004.002
		SEAGATE 40G 4200rpm ST94019A, 2MB F/W:3.05	KH.04001.010
		HGST 60G 4200rpm MORAGA IC25N060ATMR04-0 08K0634 F/W:AD4A	KH.06007.006
		Toshiba PLUTO 60G 4200rpm MK6025GAS (phase in Mar/Apr) F/W:KA200A	KH.06004.003
		HGST 80G 4200rpm MORAGA IC25N080ATMR04-0 08K635 F/W:AD4A	KH.08007.007
	TOSHIBA PLUTO 80G 4200rpm MK8025GAS, 8MB F/W:KA023A	KH.08004.001	
Keyboard			
		TM4500/TM4000/TM2300 KEYBOARD DARFON US International	KB.T5007.001
		TM4500/TM4000/TM2300 KEYBOARD DARFON Chinese	KB.T5007.002
		TM4500/TM4000/TM2300 KEYBOARD DARFON Spanish	KB.T5007.003
		TM4500/TM4000/TM2300 KEYBOARD DARFON Thai	KB.T5007.004
		TM4500/TM4000/TM2300 KEYBOARD DARFON Brazilian Protugese	KB.T5007.005
		TM4500/TM4000/TM2300 KEYBOARD DARFON Korea	KB.T5007.006
		TM4500/TM4000/TM2300 KEYBOARD DARFON UK	KB.T5007.007
		TM4500/TM4000/TM2300 KEYBOARD DARFON German	KB.T5007.008
		TM4500/TM4000/TM2300 KEYBOARD DARFON Italian	KB.T5007.009
		TM4500/TM4000/TM2300 KEYBOARD DARFON French	KB.T5007.010

**TravelMate 4000**

Picture	No.	Partname And Description	Part Number
		TM4500/TM4000/TM2300 KEYBOARD DARFON Swiss/G	KB.T5007.011
		TM4500/TM4000/TM2300 KEYBOARD DARFON Portuguese	KB.T5007.012
		TM4500/TM4000/TM2300 KEYBOARD DARFON Arabic	KB.T5007.013
		TM4500/TM4000/TM2300 KEYBOARD DARFON Belgium	KB.T5007.014
		TM4500/TM4000/TM2300 KEYBOARD DARFON Sweden	KB.T5007.015
		TM4500/TM4000/TM2300 KEYBOARD DARFON Czech	KB.T5007.016
		TM4500/TM4000/TM2300 KEYBOARD DARFON Hungaian	KB.T5007.017
		TM4500/TM4000/TM2300 KEYBOARD DARFON Norway	KB.T5007.018
		TM4500/TM4000/TM2300 KEYBOARD DARFON Danish	KB.T5007.019
		TM4500/TM4000/TM2300 KEYBOARD DARFON Turkish	KB.T5007.020
		TM4500/TM4000/TM2300 KEYBOARD DARFON Canadian French	KB.T5007.021
		TM4500/TM4000/TM2300 KEYBOARD DARFON Japanese	KB.T5007.022
		TM4500/TM4000/TM2300 KEYBOARD DARFON Greek	KB.T5007.023
		TM4500/TM4000/TM2300 KEYBOARD DARFON Hebrew	KB.T5007.024
		TM4500/TM4000/TM2300 KEYBOARD DARFON Russian	KB.T5007.025
<b>LCD Module</b>			
		LCD MODULE 14.1 IN. XGA AU B141XG05	6M.T51V7.011
		LCD 14.1 IN. TFT XGA AU B141XG05	LK.14105.006
		LCD INVERTER BOARD	19.T50V7.001





**TravelMate 4000**

Picture	No.	Partname And Description	Part Number
		LCD CABLE - 14.1 IN. XGA	50.T51V7.001
		LCD BRACKET W/HINGE 14 IN. - L	33.T51V7.001
		LCD BRACKET W/HINGE 14 IN. - R	33.T51V7.002
		LCD PANEL W/LOGO ANTENNA 14/15 IN.	60.T50V7.003
		LCD BEZEL W/RUBBER PAD 14 IN.	60.T51V7.002
		LCD MODULE 14.1 IN. XGA QDI QD141XLH12	6M.T51V7.012
		LCD 14.1 IN. TFT XGA QDI QD141XLH12	LK.14109.003
		LCD INVERTER BOARD	19.T50V7.001
		LCD CABLE - 14.1 IN. XGA	50.T51V7.001
		LCD BRACKET W/HINGE 14 IN. - L	33.T51V7.001
		LCD BRACKET W/HINGE 14 IN. - R	33.T51V7.002
		LCD PANEL W/LOGO ANTENNA 14/15 IN.	60.T50V7.003
		LCD BEZEL W/RUBBER PAD 14 IN.	60.T51V7.002
		LCD MODULE 14.1 IN. XGA CMO N141XB-L01	6M.T51V7.013
		LCD 14.1 IN. TFT XGA CMO N141XB-L01	LK.1410D.003
		LCD INVERTER BOARD	19.T50V7.001
		LCD CABLE - 14.1 IN. XGA	50.T51V7.001
		LCD BRACKET W/HINGE 14 IN. - L	33.T51V7.001
		LCD BRACKET W/HINGE 14 IN. - R	33.T51V7.002
		LCD PANEL W/LOGO ANTENNA 14/15 IN.	60.T50V7.003
		LCD BEZEL W/RUBBER PAD 14 IN.	60.T51V7.002
		LCD MODULE 15 IN. XGA AU B150XG01	6M.T50V7.011
		LCD 15" TFT XGA AU B150XG01 V2 (spwg-B)	LK.15005.001
		LCD INVERTER BOARD	19.T50V7.001

## TravelMate 4000

Picture	No.	Partname And Description	Part Number
		LCD CABLE - 15 IN. XGA	50.T50V7.004
		LCD BRACKET W/HINGE 15 IN. - L	33.T50V7.002
		LCD BRACKET W/HINGE 15 IN. - R	33.T50V7.003
		LCD PANEL W/LOGO ANTENNA 14/15 IN.	60.T50V7.003
		LCD BEZEL W/RUBBER PAD 15 IN.	60.T50V7.004
		LCD MODULE 15 IN. XGA QDI QDI150XL06-01	6M.T50V7.012
		LCD 15 IN. XGA QDI QDI150XL06-01	LK.15009.002
		LCD INVERTER BOARD	19.T50V7.001
		LCD CABLE - 15 IN. XGA	50.T50V7.004
		LCD BRACKET W/HINGE 15 IN. - L	33.T50V7.002
		LCD BRACKET W/HINGE 15 IN. - R	33.T50V7.003
		LCD PANEL W/LOGO ANTENNA 14/15 IN.	60.T50V7.003
		LCD BEZEL W/RUBBER PAD 15 IN.	60.T50V7.004
		LCD MODULE 15 IN. XGA HANNSTAR HSD150PX14-A07	6M.T50V7.013
		LCD 15 IN. XGA HANNSTAR HSD150PX14-A07	LK.15007.009
		LCD INVERTER BOARD	19.T50V7.001
		LCD CABLE - 15 IN. XGA	50.T50V7.004
		LCD BRACKET W/HINGE 15 IN. - L	33.T50V7.002
		LCD BRACKET W/HINGE 15 IN. - R	33.T50V7.003
		LCD PANEL W/LOGO ANTENNA 14/15 IN.	60.T50V7.003
		LCD BEZEL W/RUBBER PAD 15 IN.	60.T50V7.004
		LCD MODULE 15 IN. XGA SAMSUNG LTN150XB-L03	6M.T50V7.014
		LCD 15 IN. XGA SAMSUNG LTN150XB-L03	LK.15006.004
		LCD INVERTER BOARD	19.T50V7.001
		LCD CABLE - 15 IN. XGA	50.T50V7.004
		LCD BRACKET W/HINGE 15 IN. - L	33.T50V7.002
		LCD BRACKET W/HINGE 15 IN. - R	33.T50V7.003
		LCD PANEL W/LOGO ANTENNA 14/15 IN.	60.T50V7.003
		LCD BEZEL W/RUBBER PAD 15 IN.	60.T50V7.004
		LCD MODULE 15 IN. XGA HITACHI TX38D81VC1CAB	6M.T50V7.015
		LCD 15 IN. TFT XGA HITACHI TX38D81VC1CAB (SPWG-B)	LK.15004.006
		LCD INVERTER BOARD	19.T50V7.001
		LCD CABLE - 15 IN. XGA	50.T50V7.004
		LCD BRACKET W/HINGE 15 IN. - L	33.T50V7.002
		LCD BRACKET W/HINGE 15 IN. - R	33.T50V7.003
		LCD PANEL W/LOGO ANTENNA 14/15 IN.	60.T50V7.003
		LCD BEZEL W/RUBBER PAD 15 IN.	60.T50V7.004

## TravelMate 4000

Picture	No.	Partname And Description	Part Number
		LCD MODULE 15.4 IN. WXGA QDI QD15TL02-01	6M.T50V7.019
		LCD 15.4 IN. WXGA QDI QD15TL02-01	LK.15409.001
		LCD INVERTER BOARD	19.T50V7.001
		LCD CABLE - 15.4 IN. WXGA	50.T50V7.006
		LCD BRACKET W/HINGE 15.4 IN. - L	33.T50V7.004
		LCD BRACKET W/HINGE 15.4 IN. - R	33.T50V7.005
		LCD PANEL W/LOGO ANTENNA 15.4 IN.	60.T50V7.005
		LCD BEZEL W/RUBBER PAD 15.4 IN.	60.T50V7.006
<b>Main Board</b>			
		MAINBOARD 855GME M11 64MB W/PCMCIA SLOT W/O CPU MEMORY	LB.T5206.001
		MAINBOARD 855GME UMA W/PCMCIA SLOT W/O CPU MEMORY	LB.T5306.001
<b>Memory</b>			
	MEMORY	256MB NANYA SO-DIMM DDR333 256MB NT256D64SH8BAGM-6K (.14u)	KN.25603.009
	MEMORY	256M Infineon SO-DIMM DDR333 HYS64D32020GDL-6-C (.11u/B) (Sample April/M, 09/04' by firm PO)	KN.25602.022
	MEMORY	256M Infineon SO-DIMM DDR333 256MB HYS64D32020HDL-6-C 32x64 (.11u/G) (MP in Sept.)	KN.25602.012
	MEMORY	256M Micron SO-DIMM DDR333 256MB MT4VDDT3264HG-335C2	KN.25604.016
	MEMORY	256M Samsung SO-DIMM DDR333 256MB M470L3224FT0-CB3 (.13u)	KN.2560B.008
	MEMORY	256M Hynix SO-DIMM DDR333 256MB HYMD232M646D6-J AA	KN.2560G.001
	MEMORY	512M Infineon SO-DIMM DDR333 512MB HYS64D64020GBDL-6-C (.11u/B)	KN.51202.013
	MEMORY	512MB NANYA SO-DIMM DDR333 512MB NT512D64SH8A0FM-6K	KN.51203.011
	MEMORY	512MB Micron SO-DIMM DDR333 512MB MT8VDDT6464HDG-335C1 (.11u),	KN.51204.013
<b>Speaker</b>			
		SPEAKER SET	23.T50V7.001
<b>Heatsink</b>			

## TravelMate 4000

Picture	No.	Partname And Description	Part Number
		THERMAL MODULE	60.T50V7.007
		VGA HEATSINK W/PAD	34.T50V7.001
Miscellaneous			
		NAME PLATE	47.T51V7.001
		RUBBER FOOT	47.T50V7.002
		LCD SCREW RUBBER PAD	47.T50V7.003
		LCD BEZEL RUBBER PAD	47.T50V7.004
Screw			
		SCREW M2.0X3.0-I-NI-NYLOK	86.A03V7.012
		SCREW I2.5*3M-BNIH(M2.5L3)	86.T25V7.012
		SCREW M2.5*4L-BZN-NYLOK	86.A03V7.006
		SCREW M2.0X5-I-NI-NYLOK	86.T23V7.006
		SCREW MM25060IL69	86.A08V7.004
		SCREW M2.0*5-I(NI)(NYLOK)	86.T23V7.010
		SCREW M2.0X2.5-I-NI-NYLOK	86.A03V7.007
		SCREW I2*3M-NIHY (M2L3)	86.T25V7.008
		SCREW M1.7*3.0-I (BK)	86.T50V7.001
		SCREW I3*3.5M-NIH(M3L3.5)	86.A03V7.011

## TravelMate 4500

Picture	No.	Partname And Description	Part Number
Adapter			
		ADAPTER 65W 3 PIN DELTA SADP-65KB BF 19V	TBD
		ADAPTER 65W 3 PIN LITE-ON PA-1650-02 QA 19V	TBD
		ADAPTER 65W 3 PIN LI-SHIN SLS0335A 19V	TBD
Battery			
		BATTERY SANYO LI-ION 4S2P 4.4A 4UR18650F-2-QC140	TBD
		BATTERY PANASONIC LI-ION 4S2P 4.4A CGR-B/8B5AE	TBD
		BATTERY SIMPLO LI-ION 4S2P 4.4A 916-3020	TBD
Boards			
		MODEM BOARD	54.T50V7.001

## TravelMate 4500

Picture	No.	Partname And Description	Part Number
		BLUETOOTH MODULE W/ANTENNA	54.T48V7.001
		WIRELESS LAN BOARD (802.11b+g) INTEL	KI.CAX01.005
		LAUNCH BOARD	55.T50V7.001
		TOUCH PAD BOARD	55.T50V7.002
<b>Cable</b>			
		FFC CABLE - TP/B TO MB	50.T50V7.001
		MODEM CABLE	50.T50V7.002
		POWER CORD US (3 PIN)	27.A03V7.001
		POWER CORD PRC (3 PIN)	27.A03V7.003
		POWER CORD KOERA ( Pin)	27.T23V7.006
		POWER CORD EU (3 PIN)	27.A03V7.002
		POWER CORD UK (3 PIN)	27.A03V7.004
		POWER CORD ITALIAN (3 PIN)	27.A03V7.005
		POWER CORD- SWISS	27.A03V7.007
		POWER CORD AU (3 PIN)	27.A03V7.008
		POWER CORD DANISH (3 PIN)	27.A03V7.006
		POWER CORD AF (3 PIN)	27.T48V7.001
<b>Case/Cover/Bracket Assembly</b>			
		MIDDEL COVER ERGO W/BUTTON	42.T50V7.001
		UPPER CASE ERGO W/TP, TP BRACKET, TP TO TP BOARD FFC CABLE	60.T50V7.001
		LOWER CASE FOR SWAP W/SPEAKER	60.T50V7.002
		I/O BEZEL FOR DOCKING	42.T50V7.005
		DIMM/WIRELESS COVER	42.T50V7.002
		HEATSINK COVER	42.T50V7.003
		HDD COVER	42.T50V7.004
		3 IN 1 COVER	42.T50V7.006
		HDD BRACKET	33.T50V7.001
<b>Communication Module</b>			
		WIRELESS LAN ANTENNA	50.T50V7.003
<b>CPU</b>			
		INTEL PENTIUM M 1.5G 2M 400FSB uFCPGA2 SL6F9 B-1 STEPPING	KC.N0001.715
		INTEL PENTIUM M 1.6G 2M 400FSB uFCPGA2 SL7EG B-1 STEPPING	KC.N0001.725
		INTEL PENTIUM M 1.7G 2M 400FSB uFCPGA2 SL7EP B-1 STEPPING	KC.N0001.735
		INTEL PENTIUM M 1.8G 2M 400FSB uFCPGA2 SL7EN B-1 STEPPING	KC.N0001.745
		INTEL PENTIUM M 2.0G 2M 400FSB uFCPGA2 SL7EM B-1 STEPPING	KC.N0001.755
<b>Combo Module</b>			
		DVD/CDRW COMBO MODULE 24X QSI SBW-242C SWAP	6M.T50V7.001
		DVD/CDRW COMBO DRIVE 24X QSI SBW-242C	KO.02407.014
		OPTICAL DEVICE CONNECTOR BOARD W/ MYLARY	55.T50V7.003

**TravelMate 4500**

Picture	No.	Partname And Description	Part Number
		OPTICAL DEVICE HOLDER-SWAP	42.T50V7.007
		DVD/CDRW BEZEL FOR QSI	42.T50V7.008
		DVD/CDRW COMBO MODULE KME UIDA-760 SWAP	6M.T50V7.002
		DVD/CDRW COMBO DRIVE 24X KME UIDA-760	KO.02406.008
		OPTICAL DEVICE CONNECTOR BOARD W/ MYLARY	55.T50V7.003
		OPTICAL DEVICE HOLDER-SWAP	42.T50V7.007
		DVD/CDRW BEZEL FOR KME	42.T50V7.009
		DVD DUAL MODULE QSI SDW-042 SWAP	6M.T50V7.003
		DVD DUAL DRIVE QSI SDW-042	KU.00403.001
		OPTICAL DEVICE CONNECTOR BOARD W/ MYLARY	55.T50V7.003
		OPTICAL DEVICE HOLDER-SWAP	42.T50V7.007
		DVD DUAL BEZEL FOR QSI	42.T50V7.010
		DVD DUAL MODULE PIONEER DVR-K14RA SWAP	6M.T50V7.004
		DVD DUAL DRIVE PIONEER DVR-K14RA	KU.00805.001
		OPTICAL DEVICE CONNECTOR BOARD W/ MYLARY	55.T50V7.003
		OPTICAL DEVICE HOLDER-SWAP	42.T50V7.007
		DVD DUAL BEZEL FOR PIONEER	42.T50V7.011
		DVD DUAL MODULE LITE-ON SOSW-852S SWAP	6M.T50V7.005
		DVD DUAL DRIVE LITE-ON SOSW-852S	KU.00804.007
		OPTICAL DEVICE CONNECTOR BOARD W/ MYLARY	55.T50V7.003
		OPTICAL DEVICE HOLDER-SWAP	42.T50V7.007
		DVD DUAL BEZEL FOR LITE-ON	42.T50V7.012
		DVD SUPER MULTI MODULE KME UJ-830B SWAP	6M.T50V7.006
		DVD SUPER MULTI DRIVE KME UJ-830B	KU.00807.003
		OPTICAL DEVICE CONNECTOR BOARD W/ MYLARY	55.T50V7.003
		OPTICAL DEVICE HOLDER-SWAP	42.T50V7.007
		DVD SUPER MULTI BEZEL FOR KME	42.T50V7.013
		DVD SUPER MULTI MODULE HLDS GSA-4080N SWAP	6M.T50V7.007
		DVD SUPER MULTI DRIVE HLDS GSA-4080N	TBD
		OPTICAL DEVICE CONNECTOR BOARD W/ MYLARY	55.T50V7.003

## TravelMate 4500

Picture	No.	Partname And Description	Part Number
		OPTICAL DEVICE HOLDER-SWAP	42.T50V7.007
		DVD SUPER MULTI BEZEL FOR HLDS	42.T50V7.014
HDD/Hard Disk Drive			
		30G HGST 2.5" 4200 Moraga+ HTS424030M9AT00 13G1486 fw:DA1017	KH.03007.006
		Toshiba Pluto 30G 4200rpm MK3025GAS	KH.03004.002
		Seagate 30G ST93015A,2MB F/W:4.05	KH.03001.001
		40G HGST 2.5" 4200 Moraga+ HTS424040M9AT00 13G1132 fw:DA1017	KH.04007.010
		Toshiba PLUTO 40G 4200rpm MK4025GAS ,KA100A F/W:KA100A	KH.04004.002
		SEAGATE 40G 4200rpm ST94019A, 2MB F/ W:3.05	KH.04001.010
		HGST 60G 4200rpm MORAGA IC25N060ATMR04-0 08K0634 F/W:AD4A	KH.06007.006
		Toshiba PLUTO 60G 4200rpm MK6025GAS (phase in Mar/Apr) F/W:KA200A	KH.06004.003
		HGST 80G 4200rpm MORAGA IC25N080ATMR04-0 08K635 F/W:AD4A	KH.08007.007
		TOSHIBA PLUTO 80G 4200rpm MK8025GAS, 8MB F/W:KA023A	KH.08004.001
Keyboard			
		TM4500/TM4000/TM2300 KEYBOARD DARFON US International	KB.T5007.001
		TM4500/TM4000/TM2300 KEYBOARD DARFON Chinese	KB.T5007.002
		TM4500/TM4000/TM2300 KEYBOARD DARFON Spanish	KB.T5007.003
		TM4500/TM4000/TM2300 KEYBOARD DARFON Thai	KB.T5007.004
		TM4500/TM4000/TM2300 KEYBOARD DARFON Brazilian Protugese	KB.T5007.005
		TM4500/TM4000/TM2300 KEYBOARD DARFON Korea	KB.T5007.006
		TM4500/TM4000/TM2300 KEYBOARD DARFON UK	KB.T5007.007
		TM4500/TM4000/TM2300 KEYBOARD DARFON German	KB.T5007.008
		TM4500/TM4000/TM2300 KEYBOARD DARFON Italian	KB.T5007.009
		TM4500/TM4000/TM2300 KEYBOARD DARFON French	KB.T5007.010
		TM4500/TM4000/TM2300 KEYBOARD DARFON Swiss/G	KB.T5007.011
		TM4500/TM4000/TM2300 KEYBOARD DARFON Portuguese	KB.T5007.012
		TM4500/TM4000/TM2300 KEYBOARD DARFON Arabic	KB.T5007.013
		TM4500/TM4000/TM2300 KEYBOARD DARFON Belgium	KB.T5007.014
		TM4500/TM4000/TM2300 KEYBOARD DARFON Sweden	KB.T5007.015

## TravelMate 4500

Picture	No.	Partname And Description	Part Number
		TM4500/TM4000/TM2300 KEYBOARD DARFON Czech	KB.T5007.016
		TM4500/TM4000/TM2300 KEYBOARD DARFON Hungaian	KB.T5007.017
		TM4500/TM4000/TM2300 KEYBOARD DARFON Norway	KB.T5007.018
		TM4500/TM4000/TM2300 KEYBOARD DARFON Danish	KB.T5007.019
		TM4500/TM4000/TM2300 KEYBOARD DARFON Turkish	KB.T5007.020
		TM4500/TM4000/TM2300 KEYBOARD DARFON Canadian French	KB.T5007.021
		TM4500/TM4000/TM2300 KEYBOARD DARFON Japanese	KB.T5007.022
		TM4500/TM4000/TM2300 KEYBOARD DARFON Greek	KB.T5007.023
		TM4500/TM4000/TM2300 KEYBOARD DARFON Hebrew	KB.T5007.024
		TM4500/TM4000/TM2300 KEYBOARD DARFON Russian	KB.T5007.025
LCD			
		LCD MODULE 15 IN. XGA AU B150XG01	6M.T50V7.011
		LCD 15" TFT XGA AU B150XG01 V2 (spwg- B)	LK.15005.001
		LCD INVERTER BOARD	19.T50V7.001
		LCD CABLE - 15 IN. XGA	50.T50V7.004
		LCD BRACKET W/HINGE 15 IN. - L	33.T50V7.002
		LCD BRACKET W/HINGE 15 IN. - R	33.T50V7.003
		LCD PANEL W/LOGO ANTENNA 14/15 IN.	60.T50V7.003
		LCD BEZEL W/RUBBER PAD 15 IN.	60.T50V7.004
		LCD MODULE 15 IN. XGA QDI QDI150XL06- 01	6M.T50V7.012
		LCD 15 IN. XGA QDI QDI150XL06-01	LK.15009.002
		LCD INVERTER BOARD	19.T50V7.001
		LCD CABLE - 15 IN. XGA	50.T50V7.004
		LCD BRACKET W/HINGE 15 IN. - L	33.T50V7.002
		LCD BRACKET W/HINGE 15 IN. - R	33.T50V7.003
		LCD PANEL W/LOGO ANTENNA 14/15 IN.	60.T50V7.003
		LCD BEZEL W/RUBBER PAD 15 IN.	60.T50V7.004
		LCD MODULE 15 IN. XGA HANNSTAR HSD150PX14-A07	6M.T50V7.013
		LCD 15 IN. XGA HANNSTAR HSD150PX14- A07	LK.15007.009
		LCD INVERTER BOARD	19.T50V7.001
		LCD CABLE - 15 IN. XGA	50.T50V7.004
		LCD BRACKET W/HINGE 15 IN. - L	33.T50V7.002
		LCD BRACKET W/HINGE 15 IN. - R	33.T50V7.003



## TravelMate 4500

Picture	No.	Partname And Description	Part Number
		LCD PANEL W/LOGO ANTENNA 14/15 IN.	60.T50V7.003
		LCD BEZEL W/RUBBER PAD 15 IN.	60.T50V7.004
		LCD MODULE 15 IN. XGA SAMSUNG LTN150XB-L03	6M.T50V7.014
		LCD 15 IN. XGA SAMSUNG LTN150XB-L03	LK.15006.004
		LCD INVERTER BOARD	19.T50V7.001
		LCD CABLE - 15 IN. XGA	50.T50V7.004
		LCD BRACKET W/HINGE 15 IN. - L	33.T50V7.002
		LCD BRACKET W/HINGE 15 IN. - R	33.T50V7.003
		LCD PANEL W/LOGO ANTENNA 14/15 IN.	60.T50V7.003
		LCD BEZEL W/RUBBER PAD 15 IN.	60.T50V7.004
		LCD MODULE 15 IN. XGA HITACHI TX38D81VC1CAB	6M.T50V7.015
		LCD 15 IN. TFT XGA HITACHI TX38D81VC1CAB (SPWG-B)	LK.15004.006
		LCD INVERTER BOARD	19.T50V7.001
		LCD CABLE - 15 IN. XGA	50.T50V7.004
		LCD BRACKET W/HINGE 15 IN. - L	33.T50V7.002
		LCD BRACKET W/HINGE 15 IN. - R	33.T50V7.003
		LCD PANEL W/LOGO ANTENNA 14/15 IN.	60.T50V7.003
		LCD BEZEL W/RUBBER PAD 15 IN.	60.T50V7.004
		LCD MODULE 15 IN. SXGA CMO N150P2-L04	6M.T50V7.016
		LCD 15" TFT SXGA+ CMO N150P2-L04	LK.1500D.003
		LCD INVERTER BOARD	19.T50V7.001
		LCD CABLE - 15 IN. SXGA	50.T50V7.005
		LCD BRACKET W/HINGE 15 IN. - L	33.T50V7.002
		LCD BRACKET W/HINGE 15 IN. - R	33.T50V7.003
		LCD PANEL W/LOGO ANTENNA 14/15 IN.	60.T50V7.003
		LCD BEZEL W/RUBBER PAD 15 IN.	60.T50V7.004
		LCD MODULE 15 IN. SXGA AU B150PG01	6M.T50V7.017
		LCD 15" TFT SXGA+ AU B150PG01	LK.15005.002
		LCD INVERTER BOARD	19.T50V7.001
		LCD CABLE - 15 IN. SXGA	50.T50V7.005
		LCD BRACKET W/HINGE 15 IN. - L	33.T50V7.002
		LCD BRACKET W/HINGE 15 IN. - R	33.T50V7.003
		LCD PANEL W/LOGO ANTENNA 14/15 IN.	60.T50V7.003
		LCD BEZEL W/RUBBER PAD 15 IN.	60.T50V7.004
		LCD MODULE 15 IN. SXGA SAMSUNG LTN150P4-L03	6M.T50V7.018
		LCD 15 IN. TFT SXGA+ SAMSUNG LTN150P4-L03 (150nit)	LK.15006.006

## TravelMate 4500

Picture	No.	Partname And Description	Part Number
		LCD INVERTER BOARD	19.T50V7.001
		LCD CABLE - 15 IN. SXGA	50.T50V7.005
		LCD BRACKET W/HINGE 15 IN. - L	33.T50V7.002
		LCD BRACKET W/HINGE 15 IN. - R	33.T50V7.003
		LCD PANEL W/LOGO ANTENNA 14/15 IN.	60.T50V7.003
		LCD BEZEL W/RUBBER PAD 15 IN.	60.T50V7.004
		LCD MODULE 15.4 IN. WXGA QDI QD15TL02-01	6M.T50V7.019
		LCD 15.4 IN. WXGA QDI QD15TL02-01	LK.15409.001
		LCD INVERTER BOARD	19.T50V7.001
		LCD CABLE - 15.4 IN. WXGA	50.T50V7.006
		LCD BRACKET W/HINGE 15.4 IN. - L	33.T50V7.004
		LCD BRACKET W/HINGE 15.4 IN. - R	33.T50V7.005
		LCD PANEL W/LOGO ANTENNA 15.4 IN.	60.T50V7.005
		LCD BEZEL W/RUBBER PAD 15.4 IN.	60.T50V7.006
<b>Mainboard</b>			
		MAINBOARD 855GME M11 64MB DOCKING 3 IN 1 W/PCMCIA SLOT W/O CPU MEMORY	LB.T5006.001
		MAINBOARD 855GME UMA DOCKING 3 IN 1 W/PCMCIA SLOT W/O CPU MEMORY	LB.T5106.001
<b>Memory</b>			
		256MB NANYA SO-DIMM DDR333 256MB NT256D64SH8BAGM-6K (.14u)	KN.25603.009
		256M Infineon SO-DIMM DDR333 HYS64D32020GDL-6-C (.11u/B) (Sample April/M, 09/04' by firm PO)	KN.25602.022
		256M Infineon SO-DIMM DDR333 256MB HYS64D32020HDL-6-C 32x64 (.11u/G) (MP in Sept.)	KN.25602.012
		256M Micron SO-DIMM DDR333 256MB MT4VDDT3264HG-335C2	KN.25604.016
		256M Samsung SO-DIMM DDR333 256MB M470L3224FT0-CB3 (.13u)	KN.2560B.008
		256M Hynix SO-DIMM DDR333 256MB HYMD232M646D6-J AA	KN.2560G.001
		512M Infineon SO-DIMM DDR333 512MB HYS64D64020GBDL-6-C (.11u/B)	KN.51202.013
		512MB NANYA SO-DIMM DDR333 512MB NT512D64SH8A0FM-6K	KN.51203.011
		512MB Micron SO-DIMM DDR333 512MB MT8VDDT6464HDG-335C1 (.11u),	KN.51204.013
<b>Speaker</b>			
	SPEAKER	SPEAKER SET	23.T50V7.001
<b>Heatsink</b>			
		THERMAL MODULE	60.T50V7.007
		VGA HEATSINK W/PAD	34.T50V7.001
<b>Miscellaneous</b>			
		NAME PLATE	47.T50V7.001

## TravelMate 4500

Picture	No.	Partname And Description	Part Number
		RUBBER FOOT	47.T50V7.002
		LCD SCREW RUBBER PAD	47.T50V7.003
		LCD BEZEL RUBBER PAD	47.T50V7.004
Weights Saver			
		WEIGHT SAVER	60.T50V7.008
2nd HDD Base			
		2nd HDD BASE W/CONNECT	60.T50V7.009
2nd HDD Cover			
		2nd HDD COVER	42.T50V7.015
2nd HDD Bracket Kit			
		2nd HDD BRACKET KIT	6K.T50V7.001
Screw			
		SCREW M2.0X3.0-I-NI-NYLOK	86.A03V7.012
		SCREW I2.5*3M-BNIH(M2.5L3)	86.T25V7.012
		SCREW M2.5*4L-BZN-NYLOK	86.A03V7.006
		SCREW M2.0X5-I-NI-NYLOK	86.T23V7.006
		SCREW MM25060IL69	86.A08V7.004
		SCREW M2.0*5-I(NI)(NYLOK)	86.T23V7.010
		SCREW M2.0X2.5-I-NI-NYLOK	86.A03V7.007
		SCREW I2*3M-NIHY (M2L3)	86.T25V7.008
		SCREW M1.7*3.0-I (BK)	86.T50V7.001
		SCREW I3*3.5M-NIH(M3L3.5)	86.A03V7.011