

# **TravelMate 3250/2470 Series Service Guide**

Service guide files and updates are available on the ACER/CSD web; for more information, please refer to <http://csd.acer.com.tw>

PRINTED IN TAIWAN

---

## Revision History

Please refer to the table below for the updates made on TravelMate 3250/2470 service guide.

Date	Chapter	Updates

---

## Copyright

Copyright © 2006 by Acer Incorporated. All rights reserved. No part of this publication may be reproduced, transmitted, transcribed, stored in a retrieval system, or translated into any language or computer language, in any form or by any means, electronic, mechanical, magnetic, optical, chemical, manual or otherwise, without the prior written permission of Acer Incorporated.

## Disclaimer

The information in this guide is subject to change without notice.

Acer Incorporated makes no representations or warranties, either expressed or implied, with respect to the contents hereof and specifically disclaims any warranties of merchantability or fitness for any particular purpose. Any Acer Incorporated software described in this manual is sold or licensed "as is". Should the programs prove defective following their purchase, the buyer (and not Acer Incorporated, its distributor, or its dealer) assumes the entire cost of all necessary servicing, repair, and any incidental or consequential damages resulting from any defect in the software.

Acer is a registered trademark of Acer Corporation.

Intel is a registered trademark of Intel Corporation.

Pentium and Pentium II/III are trademarks of Intel Corporation.

Other brand and product names are trademarks and/or registered trademarks of their respective holders.

---

## Conventions

The following conventions are used in this manual:

<b>SCREEN MESSAGES</b>	Denotes actual messages that appear on screen.
<b>NOTE</b>	Gives bits and pieces of additional information related to the current topic.
<b>WARNING</b>	Alerts you to any damage that might result from doing or not doing specific actions.
<b>CAUTION</b>	Gives precautionary measures to avoid possible hardware or software problems.
<b>IMPORTANT</b>	Reminds you to do specific actions relevant to the accomplishment of procedures.

---

## Preface

Before using this information and the product it supports, please read the following general information.

1. This Service Guide provides you with all technical information relating to the BASIC CONFIGURATION decided for Acer's "global" product offering. To better fit local market requirements and enhance product competitiveness, your regional office MAY have decided to extend the functionality of a machine (e.g. add-on card, modem, or extra memory capability). These LOCALIZED FEATURES will NOT be covered in this generic service guide. In such cases, please contact your regional offices or the responsible personnel/channel to provide you with further technical details.
2. Please note WHEN ORDERING FRU PARTS, that you should check the most up-to-date information available on your regional web or channel. If, for whatever reason, a part number change is made, it will not be noted in the printed Service Guide. For ACER-AUTHORIZED SERVICE PROVIDERS, your Acer office may have a DIFFERENT part number code to those given in the FRU list of this printed Service Guide. You MUST use the list provided by your regional Acer office to order FRU parts for repair and service of customer machines.



# Table of Contents

<b>Chapter 1</b>	<b>System Specifications</b>	<b>1</b>
Features	.....	1
System Block Diagram	.....	4
Board Layout	.....	5
Top View	.....	5
Bottom View	.....	6
Your Acer Notebook tour	.....	8
Front view	.....	8
Closed Front View	.....	9
Left View	.....	10
Right View	.....	10
Rear Panel	.....	11
Bottom Panel	.....	12
Indicators	.....	12
Easy-Launch Buttons	.....	13
Touchpad Basics	.....	14
Using the Keyboard	.....	16
Lock Keys and embedded numeric keypad	.....	16
Windows Keys	.....	16
Hot Keys	.....	17
Special Key	.....	18
Acer Empowering Technology	.....	20
Empowering Technology password	.....	20
Acer eNet Management (for selected models)	.....	20
Acer ePower Management	.....	22
Acer ePresentation Management	.....	24
Acer eDataSecurity Management	.....	25
Acer eLock Management	.....	27
Acer eRecovery Management	.....	28
Acer eSettings Management	.....	29
Acer ePerformance Management	.....	29
Acer OrbiCam	.....	30
Enabling the Acer VisageON (for 1.3 megapixel camera models only)	.....	33
Using the System Utilities	.....	36
Acer GridVista (dual-display compatible)	.....	36
Launch Manager	.....	37
Hardware Specifications and Configurations	.....	38
<b>Chapter 2</b>	<b>System Utilities</b>	<b>49</b>
BIOS Setup Utility	.....	49
Navigating the BIOS Utility	.....	50
Information	.....	51
Main	.....	52
Advanced	.....	54
Security	.....	55
Boot	.....	59
Exit	.....	60
BIOS Flash Utility	.....	61
<b>Chapter 3</b>	<b>Machine Disassembly and Replacement</b>	<b>63</b>
General Information	.....	64
Before You Begin	.....	64

# Table of Contents

Disassembly Procedure Flowchart . . . . .	65
Removing the Battery Pack . . . . .	67
Removing the Wireless LAN Card/the HDD Module/ the Memory/the ODD Module and the LCD Module . . . . .	68
Removing the Memory and the HDD Module . . . . .	68
Removing the ODD Module . . . . .	69
Removing the LCD Module . . . . .	69
Disassembling the Main Unit . . . . .	72
Separate the Main Unit into the Upper and the Lower Case Assembly . . . . .	72
Disassembling the Lower Case Assembly . . . . .	72
Disassembling the Upper Case Assembly . . . . .	74
Disassembling the LCD Module (with video camera) . . . . .	76
Disassembling the External Modules . . . . .	79
Disassembling the HDD Module . . . . .	79
Disassembling the ODD Module . . . . .	79
<b>Chapter 4 Troubleshooting</b>	<b>81</b>
System Check Procedures . . . . .	82
External Diskette Drive Check . . . . .	82
External CD-ROM Drive Check . . . . .	82
Keyboard or Auxiliary Input Device Check . . . . .	82
Memory check . . . . .	83
Power System Check . . . . .	83
Touchpad Check . . . . .	85
Power-On Self-Test (POST) Error Message . . . . .	86
Index of Error Messages . . . . .	87
Phoenix BIOS Beep Codes . . . . .	90
Index of Symptom-to-FRU Error Message . . . . .	94
Intermittent Problems . . . . .	97
Undetermined Problems . . . . .	98
<b>Chapter 5 Jumper and Connector Locations</b>	<b>99</b>
Top View . . . . .	99
Bottom View . . . . .	100
<b>Chapter 6 FRU (Field Replaceable Unit) List 103</b>	
TravelMate 3250/2470 Exploded Diagram . . . . .	104



# System Specifications

---

## Features

Below is a brief summary of the computer's many features:

### Operating system

- Windows® Vista™ capable

**NOTE:** Windows Vista™ capable PCs come with Windows XP installed, and can be upgraded to Windows Vista™. For more information on Windows Vista™ and how to upgrade, go to: [Microsoft.com/windowsvista](http://Microsoft.com/windowsvista).

- Genuine Windows® XP Professional (Service Pack 2)
- Genuine Windows® XP Home Edition (Service Pack 2)

### Platform and memory

#### For TravelMate 3250

- Intel® Centrino® Duo mobile technology, featuring:
  - ▶ Intel® Core™ Duo processor T2300/T2400/T2500/T2600 (2 MB L2 cache, 1.66/1.83/2/2.16 GHz, 667 MHz FSB)
  - ▶ Mobile Intel® 945GM/PM Express chipset
  - ▶ Intel Pro/Wireless 3945ABG or 3945 BG network connection (dual-band tri-mode 802.11a/b/g) Wi-Fi CERTIFIED™ solution, supporting Acer SignalUp™ wireless technology
- Mobile Intel® 945GM/PM Express chipset+ICH7M
- Up to 2 GB of DDR2 533/677 MHz system memory, upgradeable to 4 GB using two soDIMM modules

#### For TravelMate 2470

- Intel® Celeron® M Processor 410/420/430 (1MB L2 cache, 1.46/1.60/1.73 GHz, 533 MHz FSB) or higher
- Mobile Intel® 940GML Express chipset+ICH7M
- Up to 2 GB of DDR2 533/677 MHz system memory, upgradeable to 2 GB using two soDIMM modules

### Display and graphics

- 14.1" WXGA Acer CrystalBrite™ TFT LCD, 1280 x 800 pixel resolution, supporting simultaneous multi-window viewing via Acer DriD Vista™
- ATI Mobility™ Radeon® X1300 with up to 512 MB of HyperMemory™ (128 MB of dedicated GDDR2 VRAM, up to 384 MB of shared system memory) supporting DualView™, ATI PowerPlay™ 5.0, Microsoft DirectX 9.0, PCI Express (**for TravelMate 3250 discrete models**)
- Mobile Intel® 945GM Express chipset with integrated 3D graphics, featuring Intel® Graphics Media Accelerator (GMA) 950 with up to 224 MB of shared system memory, supporting dual independent displays, Microsoft® DirectX® 9.0, PCI Express (**for TravelMate 3250 UMA models**)
- Mobile Intel® 940GML Express chipset with integrated 3D graphics, featuring Intel® Graphics Media Accelerator (GMA) 950 with up to 224 MB of shared system memory, supporting Microsoft® DirectX® 9.0, PCI Express (**for TravelMate 2470 models**)

- 
- 16.7 million colors
  - Simultaneous LCD and CRT display, with LCD panel resolution at 70 Hz
  - MPEG-2/DVD hardware-assisted capability

### Storage subsystem

- 60/80/100/120/160 GB hard disk drive (5400 rpm) (**for TravelMate 3250**)
- 40/60/80/100/120 GB ATA/100 hard disk drive (**for TravelMate 2470**)
- Optical drive options:
  - DVD-Super Multi double-layer
  - DVD-Dual double-layer
  - DVD/CD-RW combo drive
- 5-in-1 card reader, supporting Secure Digital (SD)m MultiMediaCard (MMC), Memory Stick® (MS), Memory Stick Pro™ (MS PRO), xD-Picture Card™ (xD) (**for TravelMate 3250**)

### Input devices

- 88-/89-key keyboard with inverted “T” cursor layout, 2.5 mm (minimum) key travel
- Touchpad with 4-way scroll button
- 12 function keys, four media keys (play/pause, stop, previous, next), four cursor keys, two Windows® keys, hotkey controls, embedded numeric keypad, international language support
- Four easy-launch buttons: Empowering Key, Internet, email, user-programmable button
- Two front-access switches: WLAN, Bluetooth®

### Audio

- Audio system with two built-in speakers (2W) and microphone
- Intel® High-Definition audio support (audio codec: ALC833)
- Sound Blaster Pro™ and MS-Sound compatible

### Communication

- Acer Video Conference featuring Voice and Video over Internet Protocol (VVoIP) support via Acer OrbiCam™ and optional Acer Bluetooth® VoIP phone
- Acer OrbiCam™ integrated 1.3 megapixel or 310,000 pixel CMOS camera (for selected models), featuring:
  - 225 degree ergonomic rotation
  - Acer VisageON™ technology (for 1.3 megapixel camera models only)
  - Acer PrimaLite™ technology
- WLAN: Intel® PRO/Wireless 3945ABG or 3945BG network connection (dual-band tri-mode 802.11a/b/g) Wi-Fi CERTIFIED™ solution, supporting Acer SignalUp™ wireless technology
- LAN: Fast Ethernet; Wake-on-LAN ready

**NOTE:** wake-on-LAN refers to “wake on LAN-on”. To be more specific, LAN packets can wake up the laptops from S3 Standby Mode (with battery or AC power in) or S4 Hibernation Mode (with AC power in). Please notice that the client needs to install a specific software to recognize the LAN packets.

- Modem: 56K ITU V.92 modem with PTT approval; Wake-on ring ready; wake (from S3 Stand-by or S4 Hibernation mode) on modem ring in

**NOTE:** wake-on ring ready refers to “wake on modem ring in”. As modem ring in, the signals can wake up the system from S3 Standby Mode (with AC power in) or S4 Hibernation Mode (with AC power)

### I/O Ports

- PC Card slot (one Type II)

- 
- 5-in-1 card reader (SD/MMC/MS/MS PRO/xD) (for TravelMate 3250)
  - 3 USB 2.0 ports
  - External display (VGA) port
  - Headphones/speaker/line-out jack
  - Microphone-in jack
  - Ethernet (RJ-45) port
  - Modem (RJ-11) port
  - DC-in jack for AC adapter

## Environment

- Temperature:
  - operating: 5° C to 35° C
  - Non-operating: -20° C to 65° C
- Humidity (non-condensing):
  - operating: 20%~80%
  - Non-operating: 20%~80%

# System Block Diagram

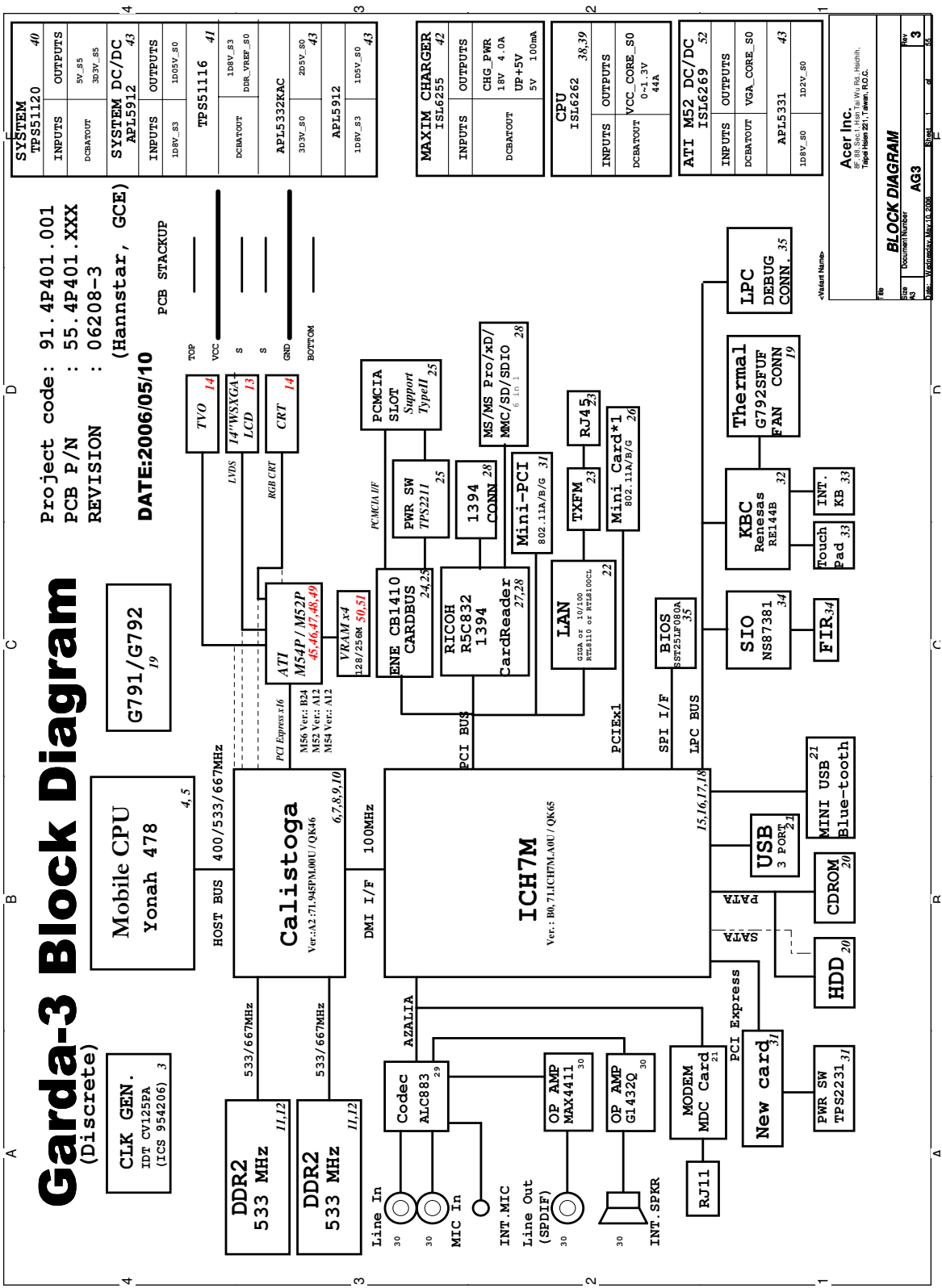

**BLOCK DIAGRAM**

Rev: \_\_\_\_\_ of \_\_\_\_\_  
 Document Number: AG3  
 Size: \_\_\_\_\_  
 Date: \_\_\_\_\_  
 Ver.: \_\_\_\_\_  
 Title: Gard-3 (Discrete) Ver. 1.0 2006

# Board Layout

## Top View

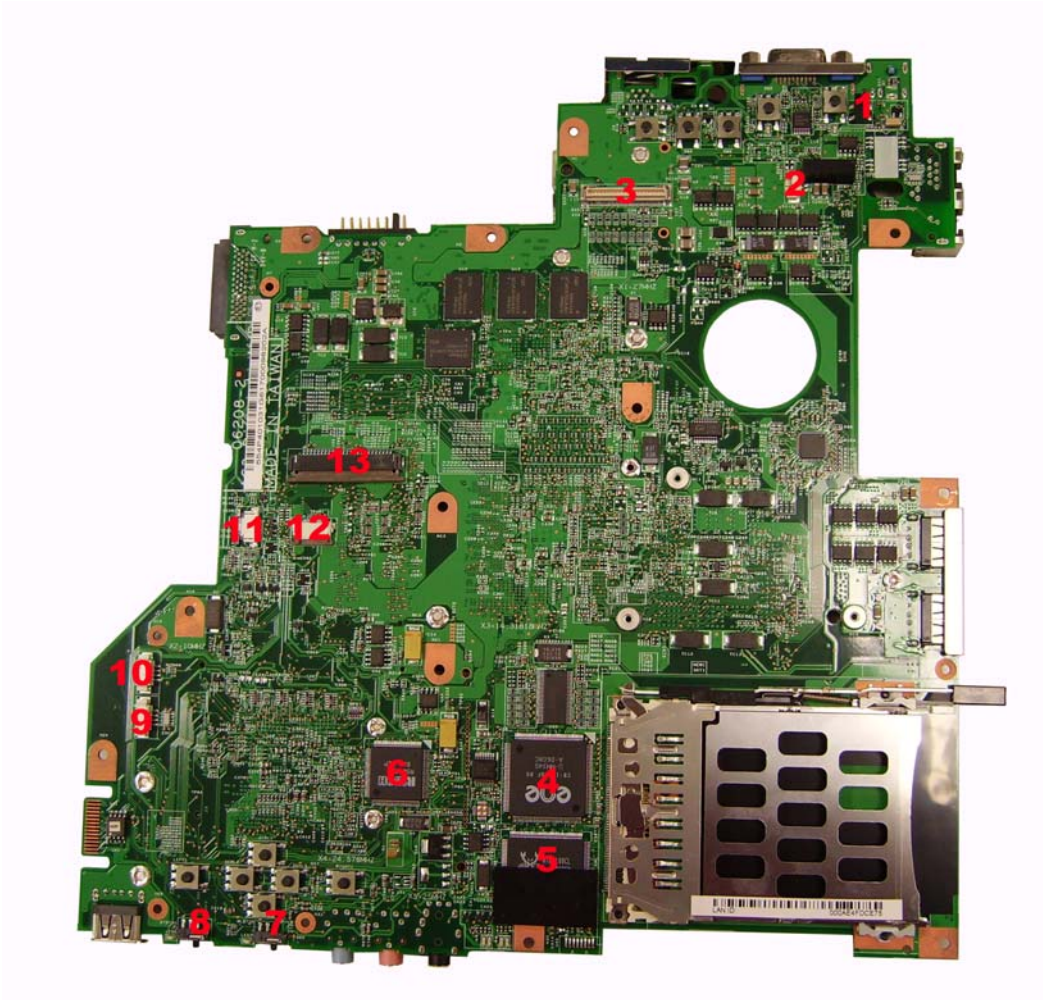

1	CVR1	LID switch	8	BTBTN1	Bluetooth launch switch
2	MIC1	Microphone cable connector	9	SPK1	Speaker set cable
3	LCD1	LCD cable connector	10	BT1	Bluetooth module cable connector
4	U38	Cardbus controller (ENE CB-1410)	11	LEDB1	LED FFC connector
5	U43	LAN controller (Realtek RTL8100CL)	12	TAPD1	Touchpad cable connector
6	N/A	Card reader controller (Ricoh R5C832)	13	KB1	Keyboard cable connector
7	WLBTN1	Wireless launch switch			

## Bottom View

**NOTE:** This is engineering sample. The image above may not be exactly the same as the real main board you get.

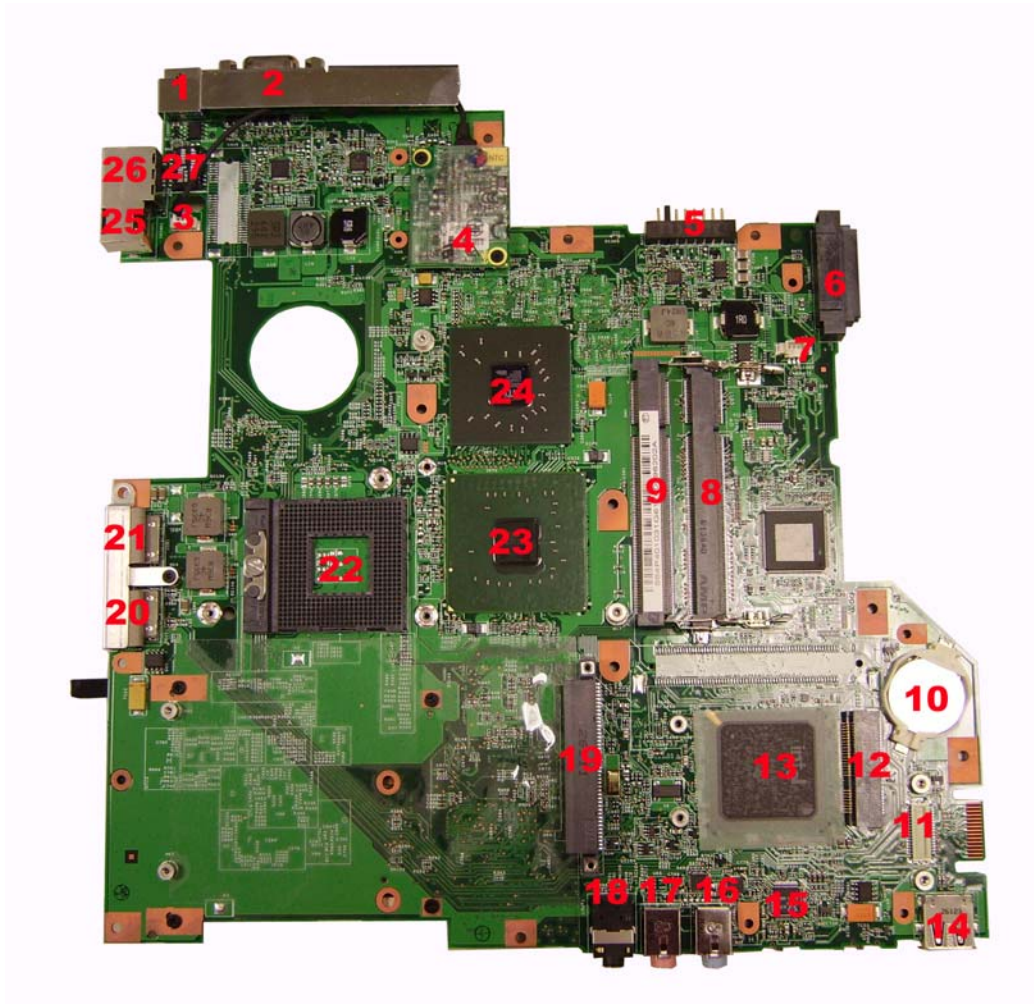

1	DCIN1	DC-in jack	14	USB3	USB port
2	CRT1	External display port	15	U67	Audio codec (Realtek ALC833)
3	N/A	Modem cable connector	16	LIN1	Line-in jack
4	MDC1	Modem board connector	17	MIC2	Microphone jack
5	BAT1	Battery connector	18	LOUT1	Headphone/speaker/line-out jack
6	CDROM1	ODD module connector	19	HDD1	HDD module connector
7	FAN1	System fan connector	20-	USB1	USB ports
8	DM2	DIMM 2 socket	21		
9	DM1	DIMM 1 socket	22	U58	CPU socket
10	RTC1	RTC battery	23	U56	North Bridge
11	CN2	Card reader board connector	24	U53	VGA controller
12	MINIC1	Wireless LAN card slot	25	TRING1	Modem jack
13	U62	South bridge (Intel ICH7M)	26	RJ1	LAN jack



# Your Acer Notebook tour

After knowing your computer features, let us show you around your new TravelMate computer.

## Front view

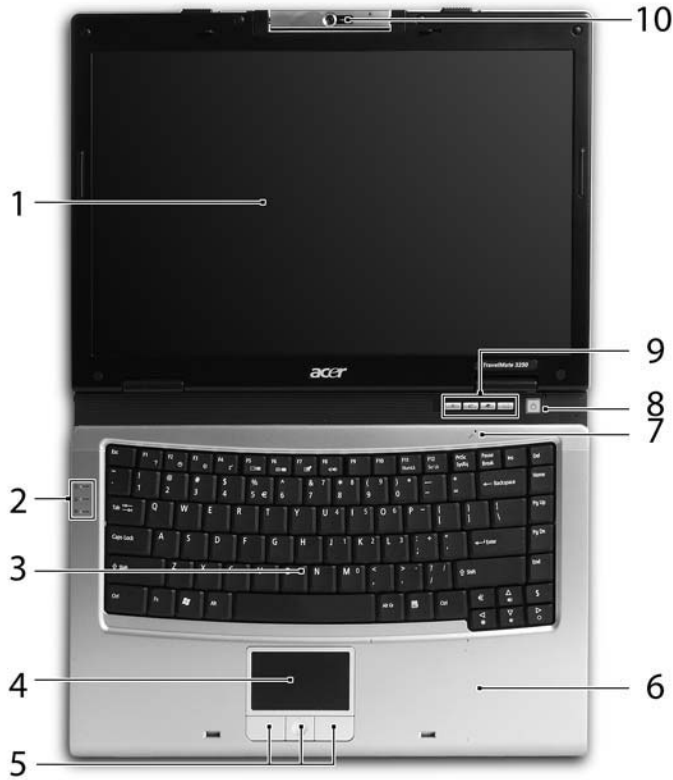









#	Icon	Item	Description
1		Display screen	Also called LCD (liquid-crystal display), displays computer output.
2		Status indicators	Light-Emitting Diodes (LEDs) that light up to show the status of the computer's functions and components.
3		Keyboard	For entering data into your computer.
4		Touchpad	Touch-sensitive pointing device which functions like a computer mouse.
5		Click buttons (left, center and right)	The left and right buttons function like the left and right mouse buttons; the center button serves as a 4-way scroll button.
6		Palmrest	Comfortable support area for our hands when you use the computer.
7		Microphone	Internal microphone for sound recording.
8		Power button	Turns the computer on and off.
9		Easy-launch Buttons	Buttons for launching frequently used programs.
10		Built-in camera	1.36 megapixel or 310,000 pixel web camera for video communication.





## Closed Front View

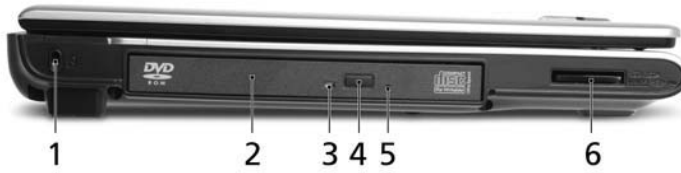

#	Icon	Item	Description
1		Speakers	Left and right speakers deliver stereo audio output.
2		USB 2.0 ports	Connect to USB 2.0 devices (e.g., USB mouse, USB camera).
3		Bluetooth® communication switch/indicator	Press to enable/disable Bluetooth function. Lights to indicate the status of Bluetooth-communications.
4		Wireless communication switch/indicator	Press to enable/disable Wireless function. Lights to indicate the status of wireless LAN communications.
5		Line-in jack	Accepts audio line-in devices (e.g., audio CD player, stereo walkman).
6		Microphone-in jack	Accepts input from external microphones.
7		Headphones/speakers/line-out jack	Connects to audio line-out devices (e.g., speakers, headphones).
8		Battery indicator	Indicates the computer's battery status.
9		Power indicator	Indicates the computer's power status
10		Latch	Locks and release the lid.

## Left View



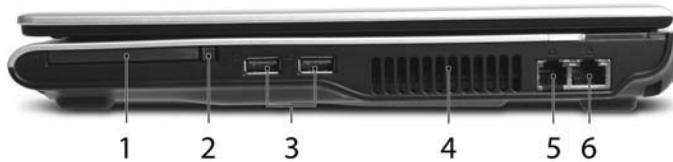

#	Icon	Item	Description
1		Kensington lock slot	Connects to a Kensington-compatible computer security lock.
2		Optical drive	Internal optical drive; accepts CDs or DVDs.
3		Optical disk access indicator	Lights up when the optical drive is active.
4		Optical drive eject button	Ejects the optical disk from the drive.
5		Emergency eject hole	Ejects the optical drive tray when the computer is turned off.
6		5-in-1 card reader	Accepts Secure Digital (SD), MultiMediaCard (MMC), Memory Stick (MS), Memory Stick PRO (MS PRO), xD-Picture Card (xD). (for selected models).

## Right View





#	Icon	Item	Description
1		PC Card slot	Accepts on Type II PC Card.
2		PC Card slot eject button	Ejects the PC Card from the slot.

3		Three USB 2.0 ports	Connect to USB 2.0 devices (e.g., USB mouse, USB camera).
4		Ventilation slots	Enable the computer to stay cool, even after prolong use.
5		Modem (RJ-11) port	Connects to a phone line.
6		Ethernet (RJ-45)	Connects to an Ethernet 10/100/1000-based network.

## Rear Panel



#	Icon	Item	Description
1		DC-in jack	Connects to an AC adapter.
		External display (VGA) port	Connects to a display device(e.g., external monitor, LCD projector).
		Battery	Powers the computer

## Bottom Panel







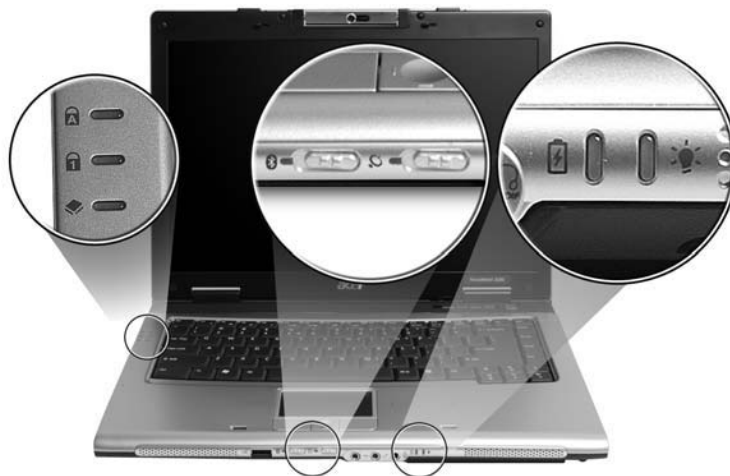

#	Item	Description
1	Battery lock	Locks the battery in position.
2	Cooling fan	Helps keep the computer cool. Note: Do not cover or obstruct the opening of the fan.
3	Acer DASP (Disk Anti-Shock Protection)	Protects the hard disk drive from shocks and bumps. (for TravelMate 3250)
4	Memory compartment	Houses the computer's main memory.
5	Battery release latch	Release the battery for removal.
6	Battery bay	Houses the computer's battery pack.

## Indicators

The computer has four easy-to-read status indicators on the upper-right above the keyboard, and four on the front panel.



The power, battery and wireless communication status indicators are visible even when the LCD display is closed.

Icon	Function	Description
	Cap lock	Lights when Cap Lock is activated
	Num lock	Lights when Num Lock is activated.
	HDD	Indicates when the hard disc or optical drive is active.
	Bluetooth	Indicates the status of Bluetooth communication.
	Wireless LAN	Indicates the status of wireless LAN communication.
	Battery	Lights up when the battery is being charged.
	Power	Lights up when the computer is on.

**NOTE:** 1. **Charging:** The light shows amber when the battery is charging. 2. **Fully charged:** The light shows green when in AC mode.

## Easy-Launch Buttons

Located above the keyboard are four buttons. These buttons are called easy-launch buttons. They are: mail Web browser, Empowering Key “*e*” and one user-programmable button.

Press “*e*” to run the Acer Empowering Technology. The mail and Web browser buttons are pre-set to email and Internet programs, but can be reset by users. To set the Web browser, mail and programmable buttons, run the Acer Launch Manager.



Launch key	Default application
P	User-programmable
e	Acer Empowering Technology (user-programmable)
Web browser	Internet browser (user-programmable)
Mail	Email application (user-programmable)

## Touchpad Basics

The following teaches you how to use the touchpad:

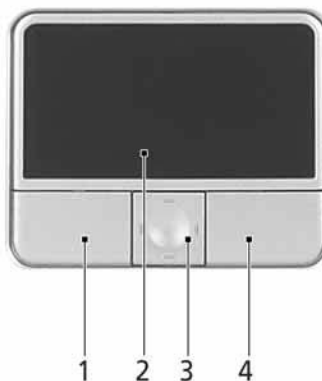

- Move your finger across the touchpad (2) to move the cursor.
- Press the left (1) and right (4) buttons located beneath the touchpad to perform selection and execution functions. These two buttons are similar to the left and right buttons on a mouse. Tapping on the touchpad is the same as clicking the left button.
- Use the 4-way scroll (3) button to scroll up or down and move left or right a page. This button mimics your cursor pressing on the right scroll bar of Windows applications.

Function	Left Button (1)	Right Button (4)	Main touchpad (2)	Center button (3)
Execute	Click twice quickly		Tap twice (at the same speed as double-clicking the mouse button)	
Select	Click once		Tap once	
Drag	Click and hold, then use finger to drag the cursor on the touchpad		Tap twice (at the same speed as double-clicking a mouse button) then hold finger to the touchpad on the second tap to drag the cursor.	
Access context menu		Click once		
Scroll				Click and hold to move up/down/left/right.

**NOTE:** Keep your fingers dry and clean when using the touchpad. Also keep the touchpad dry and clean. The touchpad is sensitive to finger movements. Hence, the lighter the touch, the better the response. Tapping too hard will not increase the touchpad's responsiveness.

# Using the Keyboard

The keyboard has full-sized keys and an embedded keypad, separate cursor keys, two Windows keys and twelve function keys.

## Lock Keys and embedded numeric keypad

The keyboard has three lock keys which you can toggle on and off.



Lock Key	Description
Caps Lock	When Caps Lock is on, all alphabetic characters typed are in uppercase.
Num lock <Fn>+<F11>	When Num Lock is on, the embedded keypad is in numeric mode. The keys function as a calculator (complete with the arithmetic operators +, -, *, and /). Use this mode when you need to do a lot of numeric data entry. A better solution would be to connect an external keypad.
Scroll lock <Fn>+<F12>	When Scroll Lock is on, the screen moves one line up or down when you press the up or down arrow keys respectively. Scroll Lock does not work with some applications.









The embedded numeric keypad functions like a desktop numeric keypad. It is indicated by small characters located on the upper right corner of the keycaps. To simplify the keyboard legend, cursor-control key symbols are not printed on the keys.

Desired Access	Num Lock On	Num Lock Off
Number keys on embedded keypad	Type numbers in a normal manner.	
Cursor-control keys on embedded keypad	Hold <Shift> while using cursor-control keys.	Hold <Fn> while using cursor-control keys.
Main keyboard keys	Hold <Fn> while typing letters on embedded keypad.	Type the letters in a normal manner.

## Windows Keys

The keyboard has two keys that perform Windows-specific functions.





Key	Icon	Description
Windows key 		<p>Pressed alone, this key has the same effect as clicking on the Windows Start button; it launches the Start menu. It can also be used with other keys to provide a variety of function:</p> <ul style="list-style-type: none"> <li> + &lt;Tab&gt; Activates next taskbar button.</li> <li> + &lt;E&gt; Opens the My Computer window</li> <li> + &lt;F1&gt; Opens Help and Support.</li> <li> + &lt;F&gt; Opens the Find: All Files dialog box.</li> <li> + &lt;R&gt; Opens the Run dialog box.</li> <li> + M Minimizes all windows.</li> </ul> <p>&lt;Shift&gt;+  + &lt;M&gt; Undoes the minimize all windows action.</p>
 Application key		This key has the same effect as clicking the right mouse button; it opens the application's context menu.













## Hot Keys

The computer employs hotkeys or key combinations to access most of the computer's controls like screen brightness, volume output and the BIOS utility.

To activate hot keys, press and hold the <Fn> key before pressing the other key in the hotkey combination.



Hot Key	Icon	Function	Description
Fn-F1	?	Hot key help	Displays help on hot keys.
Fn-F2		Acer eSetting	Launches the Acer eSettings in Acer eManager.
Fn-F3		Acer ePowerManagement	Launches the Acer ePowerManagement in Acer eManager.

Hot Key	Icon	Function	Description
Fn-F4		Sleep	Puts the computer in Sleep mode.
Fn-F5		Display toggle	Switches display output between the display screen, external monitor (if connected) and both.
Fn-F6		Screen blank	Turns the display screen backlight off to save power. Press any key to return.
Fn-F7		Touchpad toggle	Turns the internal touchpad on and off.
Fn-F8		Speaker toggle	Turns the speakers on and off.
Fn- 		Volume up	Increases the speaker volume.
Fn- 		Volume down	Decreases the speaker volume.
Fn- 		Brightness up	Increases the screen brightness.
Fn- 		Brightness down	Decreases the screen brightness

## Special Key

You can locate the Euro symbol and US dollar sign at the upper-center and/or bottom-right of your keyboard. To type:

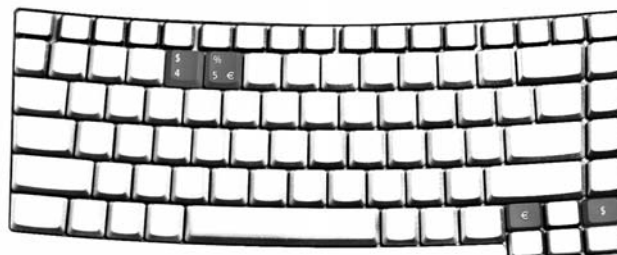

### The Euro symbol

1. Open a text editor or word processor.

- 
2. Either directly press the **<Euro>** symbol at the bottom-right of the keyboard, or hold **<Alt Gr>** and then press the **<5>** symbol at the upper-center of the keyboard.

### The US dollar sign

1. Open a text editor or word processor.
2. Either directly press the **<Dollar>** key at the bottom-right of the keyboard, or hold **<Shift>** and then press the **<4>** key at the upper-center of the keyboard.

**NOTE:** This function varies by the operating system version.

**NOTE:** Some fonts and software do not support the Euro symbol. Please refer to [www.microsoft.com/typography/faq/faq12.htm](http://www.microsoft.com/typography/faq/faq12.htm) for more information.

---

## Acer Empowering Technology

Acer's innovative Empowering Technology makes it easy for you to access frequently used functions and manage your new Acer notebook. It features the following handy utilities:

- ❑ **Acer eNet Management** hooks up to location-based networks intelligently (for selected models)
- ❑ **Acer ePower Management** extends battery power via versatile usage profiles.
- ❑ **Acer ePresentation Management** connects to a projector and adjusts display settings conveniently.
- ❑ **Acer eDataSecurity Management** protects data with passwords and advanced encryption algorithms (for selected models)
- ❑ **Acer eLock Management** limits access to external storage media.
- ❑ **Acer eRecovery Management** backs up and recovers data flexibly, reliably and completely.
- ❑ **Acer eSettings Management** accesses system information and adjusts settings easily.
- ❑ **Acer ePerformance Management** improves system performance by optimizing disk space, memory and registry settings.



For more information, press the < *e* > key to launch the Empowering Technology menu, then click on the appropriate utility and select the Help or Tutorial function.

### Empowering Technology password

Before using Acer eLock Management and Acer eRecovery Management, you must initialize the Empowering Technology password. Right-click on the Empowering Technology toolbar and select "Password Setup" to do so. If you do not initialize the Empowering Technology password, you will be prompted to do so when running Acer eLock Management or Acer eRecovery Management for the first time.

### Acer eNet Management (for selected models)

Acer eNet Management helps you to quickly and easily connect to both wired and wireless networks in a variety of locations. To access this utility, either click on the "**Acer eNet Management**" icon on your netebook, or start the program from the Start menu. You also have the option to set Acer eNet Management to start automatically when you boot up your PC.

Acer eNet Management automatically detects the best settings for a new location, while offering you the freedom to manually adjust the settings to match your needs.



Acer eNet Management can save network settings for a location to a profile, and automatically switch to the appropriate profile when you move from one location to another. Settings stored include network connection settings (IP and DNS settings, wireless AP details, etc.), as well as default printer settings.

Security and safety concerns mean that Acer eNet Management does not store username and password information.

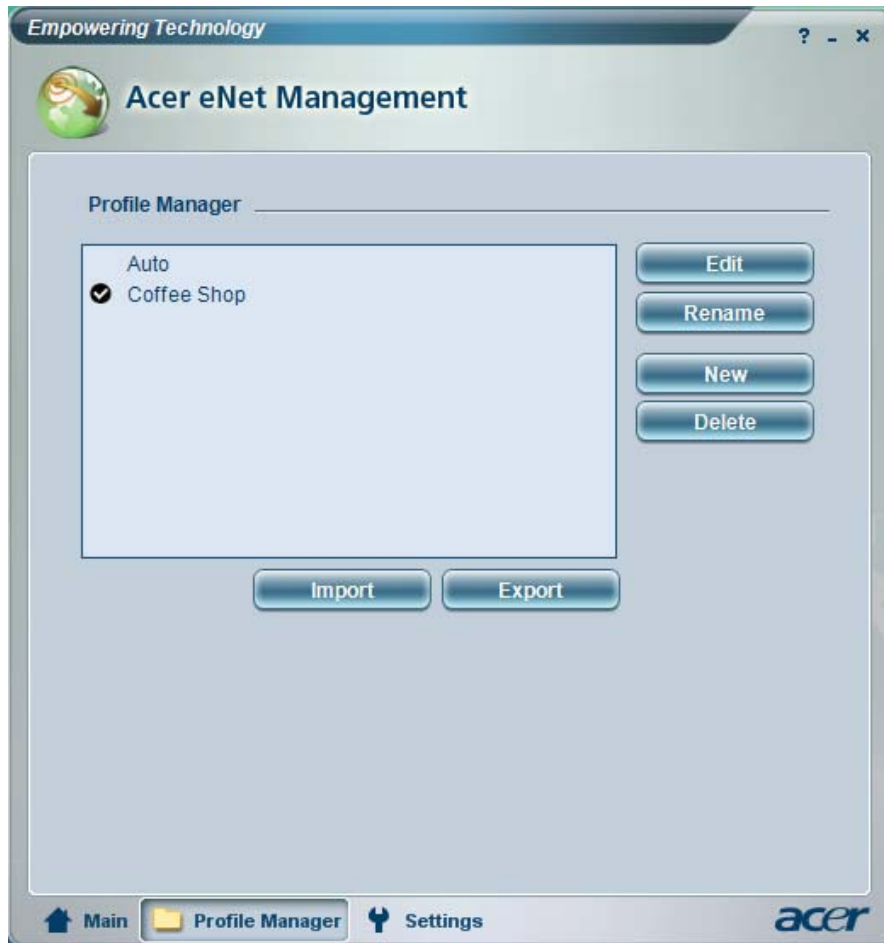

## Acer ePower Management

Acer ePower Management features a straightforward user interface. To launch it, select Acer ePower Management from the Empowering Technology interface.

### AC Mode (Adapter mode)

The default setting is “Maximum Performance.” You can adjust CPU speed, LCD brightness and other settings, or click on buttons to turn the following functions on/off: Wireless LAN, Bluetooth, CardBus, FireWire (1394), Wired LAN and Optical Device if supported.

### DC Mode (Battery mode)

There are four pre-defined profiles - Entertainment, Presentation, Word Processing, and Battery Life. You can also define up to three of your own.

### To create new power profile

1. Change power settings as desired.
2. Click “Save as...” to save to a new power profile.
3. Name the newly created profile.
4. Select whether this profile is for Adapter or Battery mode, then click OK.

5. The new profile will appear in the profile list.

## Battery status

For real-time battery life estimates based on current usage, refer to the panel on the lower left-hand side of the window.



For additional options, click **“Settings”** to:

- Set alarms.
- Re-load factory defaults.
- Select what actions will be taken when the cover is closed or the power button is pressed.
- View information about Acer ePower Management.



## Acer ePresentation Management

Acer ePresentation Management lets you project your computer's display to an external device or project using the hot key: Fn + F5. If auto-detection hardware is implemented in the system, your system display will be automatically switched out when an external display is connected to the system.



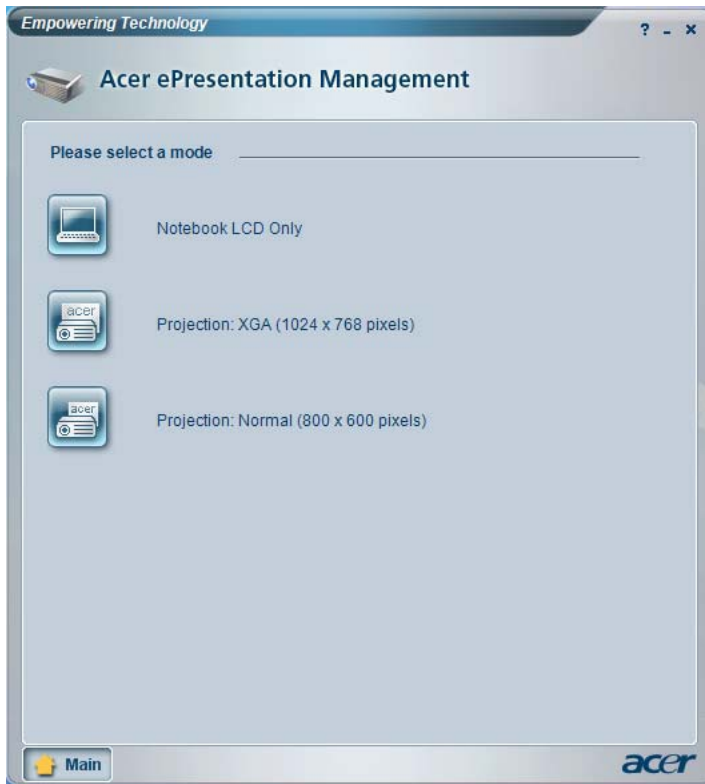

## Acer eDataSecurity Management

Acer eDataSecurity Management is handy file encryption utility that protects your files from being accessed by unauthorized persons. It is conveniently integrated with Windows explorer as a shell extension for quick and easy data encryption/decryption and also supports on-the-fly file encryption for MSN Messenger and Microsoft Outlook.

The Acer eDataSecurity Management setup wizard will prompt you for a supervisor password and default encryption. This encryption will be used to encrypt files by default, or you can choose to enter your own file-specific password when encrypting a file.

**NOTE:** The password used to encrypt a file is the unique key that the system needs to decrypt it. If you lose the password, the supervisor password is the only other key capable of decrypting the file. If you lose both passwords, there will be no way to decrypt your encrypted file! **Be sure to safeguard all related passwords!**

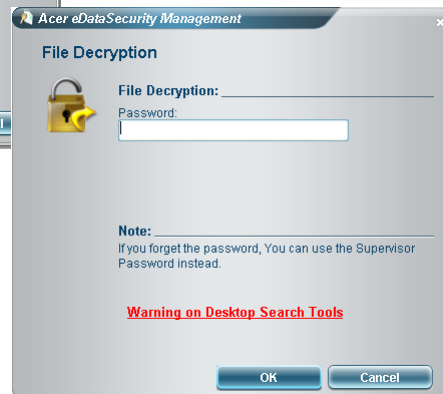
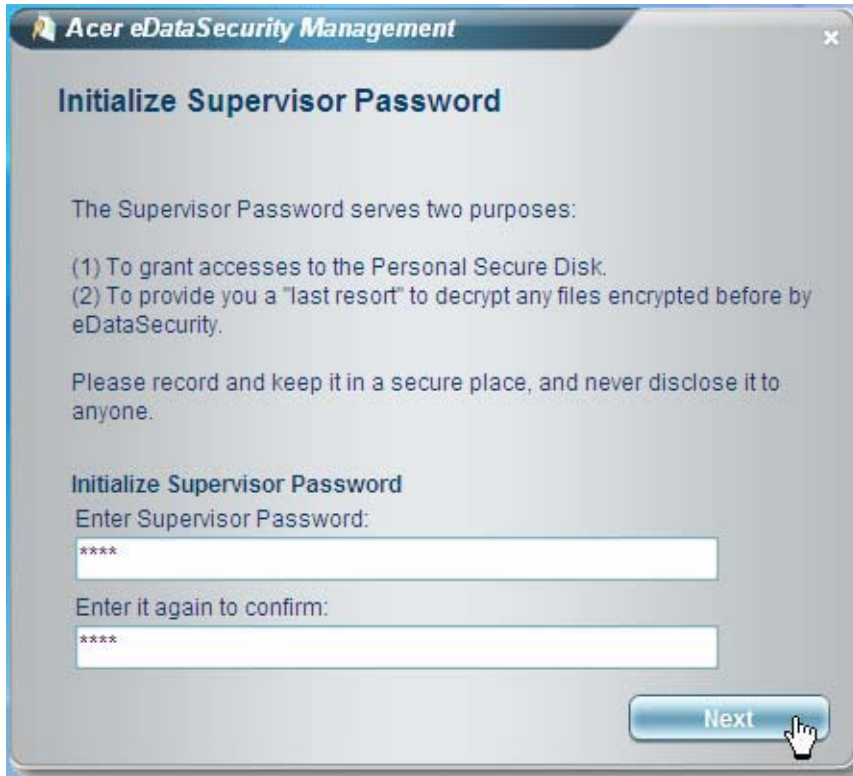

## Acer eLock Management

Acer eLock Management is a security utility that allows you to lock your removable data, optical and floppy drives to ensure that data can't be stolen while your notebook is unattended.

- Removable data devices - includes USB disk drives, USB pen drives, USB flash drives, USB MP3 drives, USB memory card readers, IEEE 1394 disk drives and any other removable disk drives that can be mounted as a file system when plugged into the system.
- Optical drive devices - includes any kind of CD-ROM or DVD-ROM drives.
- Floppy disk drives - 3.5-inch disks only.
- Interfaces - includes serial ports, parallel port, infrared (IR), and Bluetooth.

To activate Acer eLock Management, a password must be set first. Once set, you can apply locks to any of the devices. Lock(s) will immediately be set without any reboot necessary, and will remain locked after rebooting, until unlocked.

**NOTE:** If you lose your password, there is no method to reset it except by reformatting your notebook or taking your notebook to an Acer Customer Service Center. Be sure to remember or write down your password.

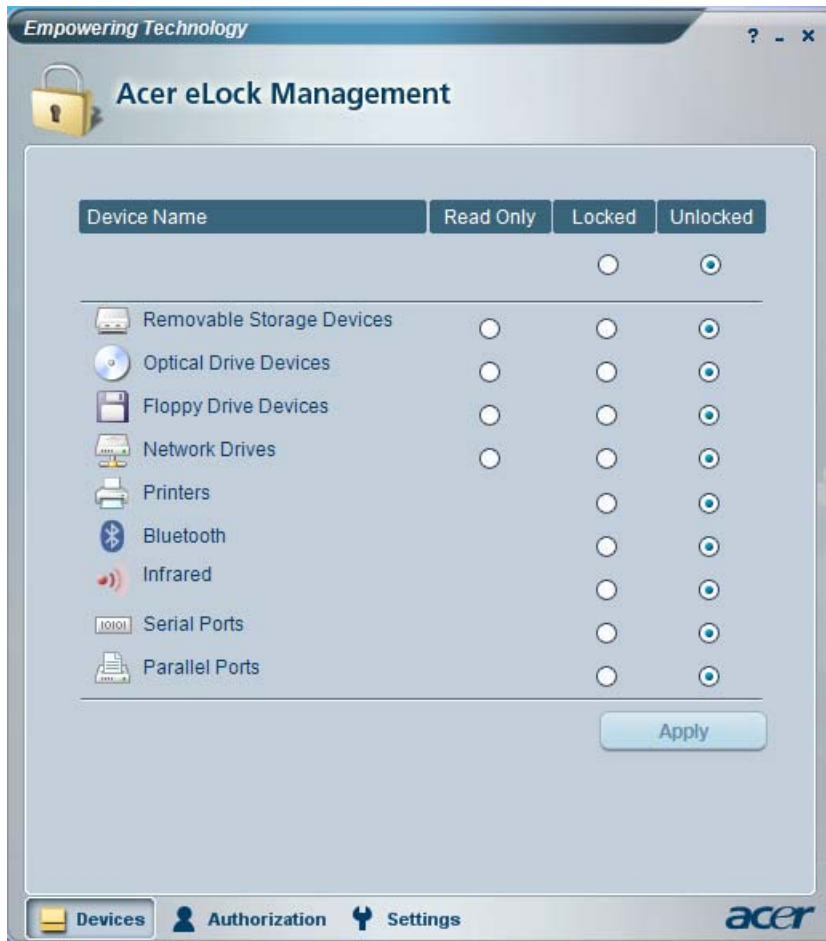

## Acer eRecovery Management

Acer eRecovery Management is a powerful utility that does away with the need for recovery disks provided by the manufacturer. The Acer eRecovery Management utility occupies space in a hidden partition on your system's HDD. User-created backups are stored on D:\ drive. Acer eRecovery Management provides you with:

- Password protection.
- Recovery of applications and drivers.
- Image/data backup:
  - Back up to HDD (set recovery point).
  - Back up to CD/DVD.
- Image/data recovery tools:
  - Recover from a hidden partition (factory defaults).
  - Recover from the HDD (most recent user-defined recovery point).
  - Recover from CD/DVD.

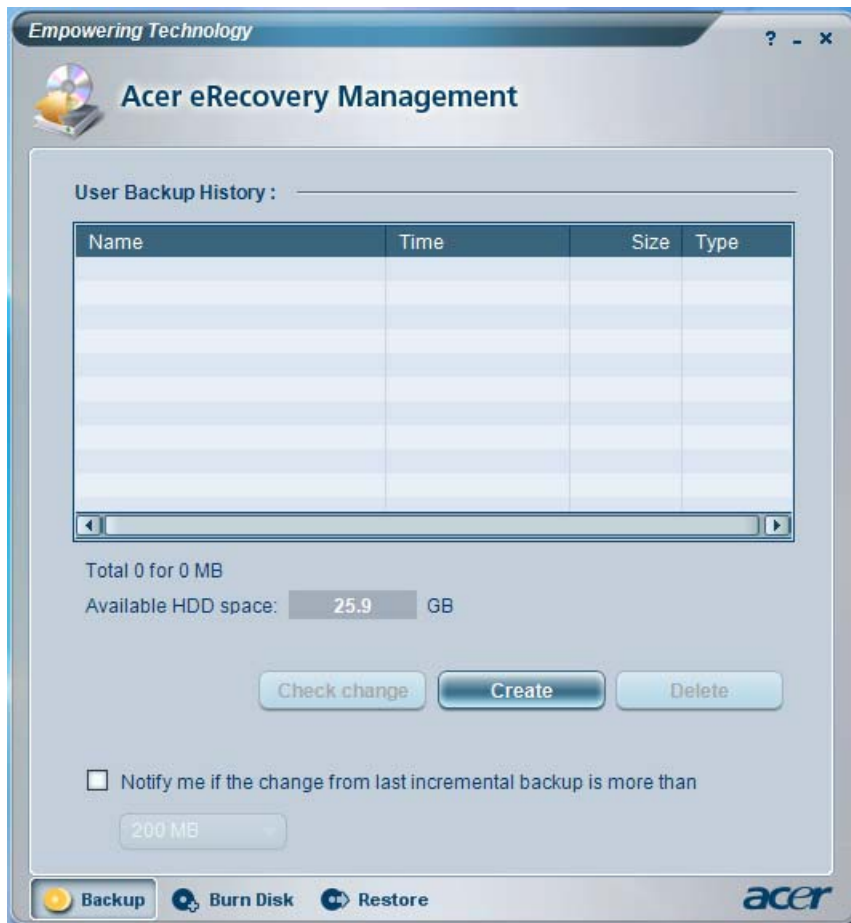

For more information, please refer to “Acer eRecovery Management”

**NOTE:** If your computer did not come with a Recovery CD or System CD, please use Acer eRecovery Management’s “System backup to optical disk” feature to burn a backup image to CD or DVD. To ensure the best results when recovering your system using a CD or Acer eRecovery Management, detach all peripherals (except the external Acer ODD, if your computer has one), including your Acer ezDock.

## Acer eSettings Management

Acer eSettings Management allows you to inspect hardware specifications and to monitor the system health status. Furthermore, Acer eSettings Management enables you to optimize your Windows operating system, so your computer runs faster, smoother and better.

Acer eSettings Management also:

- Provides a simple graphical user interface for navigating.
- Displays general system status and advanced monitoring for power users.



## Acer ePerformance Management

Acer ePerformance Management is a system optimization tool that boosts the performance of your Acer notebook. It provides an express optimization method to release unused memory and disk space quickly. The user can also enable advanced options for full control over the following option:

- Memory optimization - releases unused memory and check usage.
- Disk optimization - removes unneeded items and files.
- Speed optimization - improves the usability and performance of your Windows XP system.



## Acer OrbiCam

The Acer OrbiCam is a 1.3 megapixel CMOS camera appropriately mounted on the top of the LCD panel. The camera's 225-degree ergonomic rotation allows you to capture high-resolution photos or videos up front or at the back of the LCD panel. The Acer OrbiCam fully supports the Acer Video Conference technology so that you can transmit the best video quality over an instant Messenger service.

### Getting to know your Acer OrbiCam

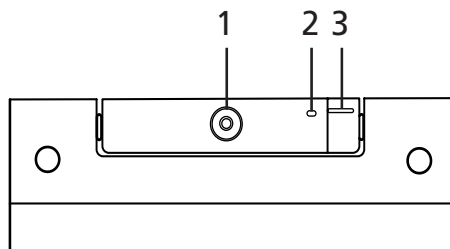

No.	Item
1	Lens
2	Power indicator

---

No.	Item
3	Rubber grip (selected models only)

### Rotating the Acer Orbicam

The Acer Orbicam rotates 225 degrees counterclockwise to achieve the desired angle. Refer to the illustrations below:

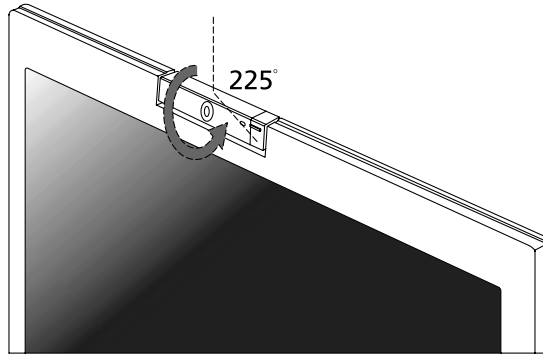

For your convenience, the camera snaps 45 degrees to match the position of your face in front or at the back of the LCD panel.

**NOTE:** Do not rotate the camera clockwise to prevent damage to the device.

### Launching the Acer Orbicam

To launch the Acer Orbicam, double click on the Acer Orbicam icon on the screen.

OR

Click Start > All programs > Acer > Acer Orbicam. The Acer Orbicam capture windows window appears.

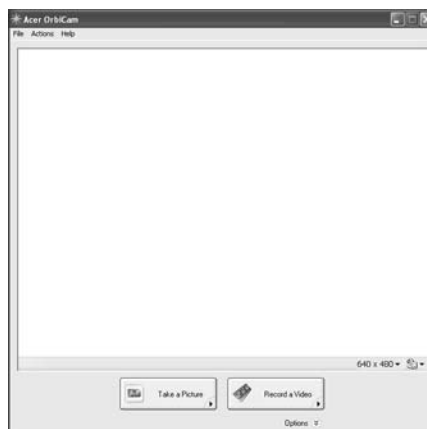

### Changing the Acer Orbicam settings

Resolution

To change the capture resolution, click the displayed resolution at the bottom right corner of the capture window, then select the desired resolution.



**NOTE:** Settings the camera resolution to 640 x480 larger does not change the capture window size.

### Options

Click **Options** to display the **Window**, **Preview**, and **Folder** tabs. Use the options to change the capture window size, preview settings, and the folder for captured photos or videos.

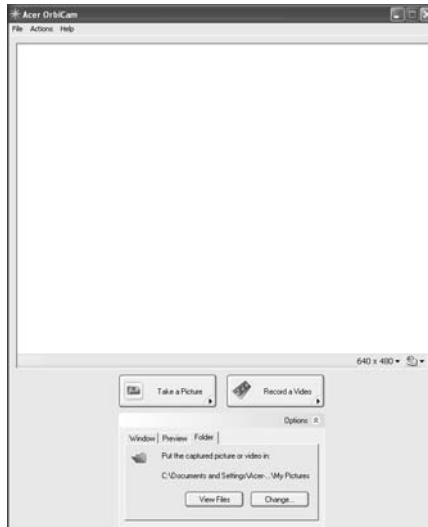

### Camera Settings

- ❑ Basic settings: Click the Camera Settings icon on the bottom right corner of the capture display, then select **Camera Settings** from the pop-up menu. You can adjust the **Video**, **Audio**, and **Zoom/Face tracking** options from this window.





- ❑ Capture settings: From the Camera Settings window, click the Driver Settings button. The Properties window will appear.



- ❑ Device Settings allows you to change the camera brightness, contrast, hue, saturation, sharpness, etc.
- ❑ Advanced Settings allows you to achieve gain control, implement image mirror, select image enhancements and anti-flicker settings, and turn on/off the camera indicator.
- ❑ Zoom/Face Track Settings allows you to adjust the zoom level and turn the face tracking feature on or off.

### Capturing photos or videos

To capture a photo or a video clip, rotate the Acer OrbiCam to get the desired angle, then click the Take a Picture or Record a Video button. The Windows Picture and Fax Viewer or the Windows Media Player automatically launches to display or play a preview of the photo/video clip.

**NOTE:** By default, all photos and videos are saved in the My Pictures and My Videos folder.

### Using the Acer OrbiCam as webcam

The Acer OrbiCam is automatically selected as the capture device of any instant messenger (IM) application. To use the Acer OrbiCam as a webcam, open the IM service, then select the video/webcam feature. You can now broadcast from your location to an IM partner anywhere in the world.

### Enabling the Acer VisageON (for 1.3 megapixel camera models only)

The Acer VisageON technology comes with two features: Face tracking and Video effects (selected models only). The Face Tracking feature tracks your head movement and automatically centers your face in the capture window. The video effects feature allows you to select and apply an effect to your video transmissions.

**NOTE:** The face tracking feature is not capable of centering your face beyond the capture window frame. Minimal head movements are tracked more efficiently.

To enable the Acer VisageON:

1. Right click on this icon, then select VisageON from the pop-up menu.

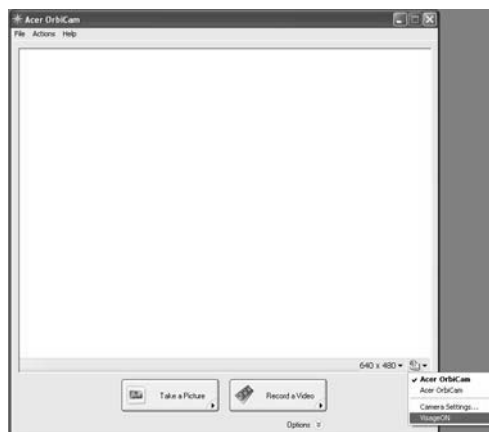

The VisageON window appears as below:



2. Select and apply a video effect in the left section of the VisageON window. Change the face tracking settings and options in the right section.

Using the face tracking feature

To use the face tracking feature:

1. Click the left icon down arrow button, then select Single User or Multiple Users from the pop-up menu. For multiple users, the face tracking feature automatically centers all the users' face in the capture window, otherwise the utility centers the face of the user closest to the camera.



2. Click the right icon to zoom in/out or reset the current view.



3. Click VisageON to display a menu that allows to change the configuration of the camera, face tracking and video effects settings.

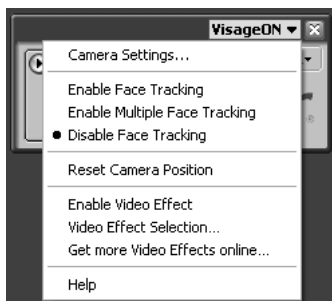

### Using video effects (selected models only)

The Video Settings section allows you to select an avatar or accessory video effect from the list. To select an effect:

1. Click the encircled icon to display the available video effects. The Video Effect Selection window appears as below:



2. Click on a video effect to use. The selected effect appears in the video effects section of the VisageON window.

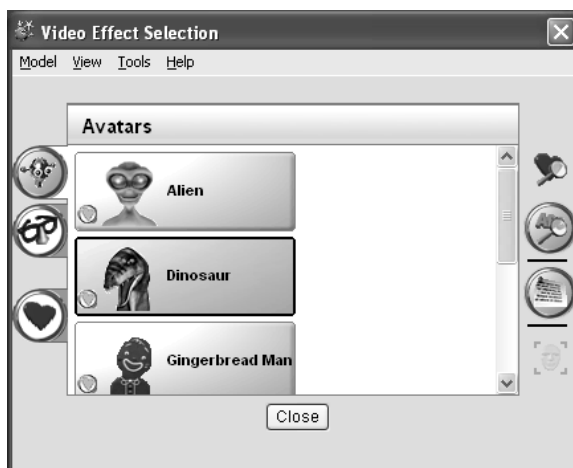

**NOTE:** When using avatars, you may have to calibrate the face points to achieve better tracking. Follow screen instructions in the VisageON to continue.

**NOTE:** You may use video effects when using the camera for IM chat/video sessions or call conferences.

# Using the System Utilities

**NOTE:** The system utilities work under Microsoft Windows XP only.

## Acer GridVista (dual-display compatible)

**NOTE:** This feature is only available on certain models.

To enable the dual monitor feature of the notebook, first ensure that the second monitor is connected, then select **Start, Control Panel, Display** and click on **Settings**. Select the secondary monitor (**2**) icon in the display box and then click the check box **Extend my windows desktop onto this monitor**. Finally, click **Apply** to confirm the new settings and click **OK** to complete the process.

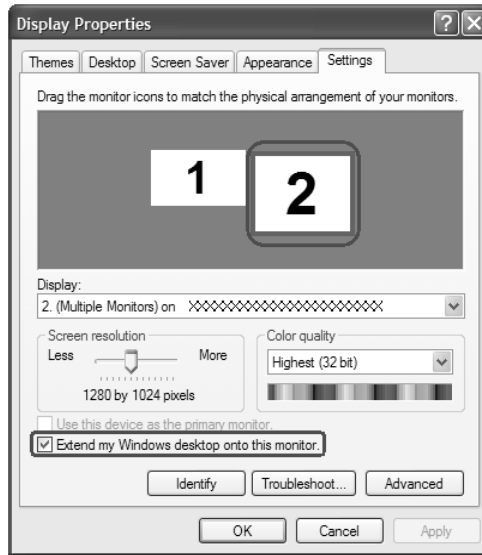

Acer GridVista is a handy utility that offers four pre-defined display settings so you can view multiple windows on the same screen. To access this function, please go to **Start>All Programs** and click on **Acer GridVista**. You may choose any one of the four display settings indicated below:



Double (verticle), Triple (primary at left), Triple (primary at right), or Quad Acer Gridvista is dual-display compatible, allowing two displays to be partitioned independently.

Acer Gridvista is dual-display compatible, allowing two displays to be partitioned independently.

AcerGridVista is imple to set up:

1. Run Acer GridVista and select your preferred screen configuration for each display from the task bar.
2. Drag and drop each window into the appropriate grid.
3. Enjoy the convenience of a well-organized desktop.

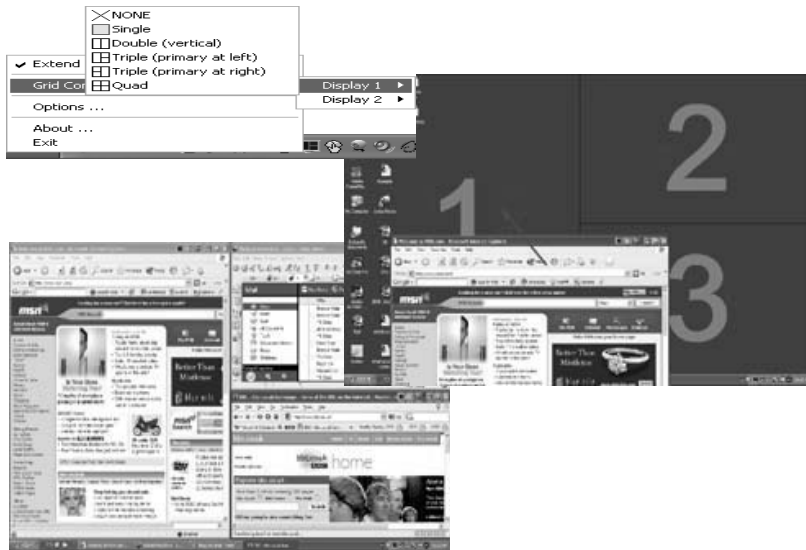

**NOTE:** Please ensure that the resolution setting of the second monitor is set to the manufacturer's recommended value.

## Launch Manager

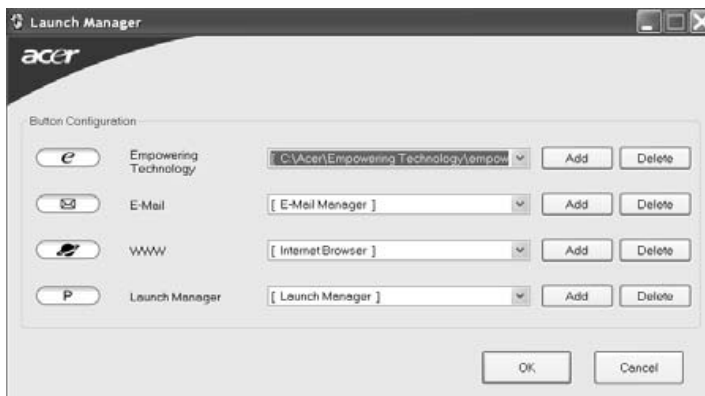

Launch Manager allows you to set the four easy-launch buttons located above the keyboard. You can access the Launch Manager by clicking on Start > All Programs > Launch Manager to start the application.

# Hardware Specifications and Configurations

## Processor

Item	Specification
CPU type	Intel® Core™ Duo processor T2300/T2400/T2500/T2600 (2 MB L2 cache, 1.66/1.83/2/2.16 GHz, 667 MHz FSB) for TravelMate 3250 Intel® Celeron® M Processor 410/420/430 (1MB L2 cache, 1.46/1.60/1.73 GHz, 533 MHz FSB) or higher for TravelMate 2470
Core logic	Intel 945GM/PM+ICH7M (for TravelMate 3250) Intel 940GML+ICH7M (for TravelMate 2470)
CPU package	Intel socketable 478pin Micro-BGA
CPU core voltage	0.944~1.3V

## CPU Fan True Value Table

Stage	DTS(degree C)	Local	Fan Speed (rpm)	Acoustic Level (dBA)
Stage 1	50	56	2800	29
Stage 2	60	60	3200	32
Stage 3	70	65	3600	35
Stage 4	82	70	4000	38
Stage 5	93	77	4300	40

**NOTE:** Stage 1-4 is normal situation. Stage 5 is protection while the CPU is at extremely high temperature or at critical situation. DTS refers to the CPU's temperature; and Local means the temperature of the IC on the main board.

## BIOS

Item	Specification
BIOS vendor	Phneoix
BIOS Version	V1.05 (MP version)
BIOS ROM type	Flash ROM
BIOS ROM size	512KB Flash BIOS
BIOS package	32-pin PLCC
Supported protocols	ACPI 1.0b/2.0/3.0 compliance, PCI2.2, System/HDD Password Security Control, INT 13h Extensions, PnP BIOS 1.0a, PC Card 95(PCMCIA 3.0 Compliant Device), SM BIOS 2.4, BIOS Boot Specification, Simple Boot Flag 1.0, Boot Block, PCI Bus Power Management Interface Specification, USB 1.1/2.0, IEEE1394 1.0, USB/1394 CD-ROM Boot Up support, IrDA 1.0, HD Audio, WfM 2.0, PXE 2.1, BIS 1.0, PC99a and Mobile PC2001 Compliant, Intel Enhanced SpeedStep Technology, DMI 2.0, PS/2 keyboard and mouse
BIOS password control	Set by setup manual

## Second Level Cache

Item	Specification
Cache controller	Built-in CPU
Cache size	2MB for Intel® Core™ Duo processor 1MB for Intel® Celeron® M Processor
1st level cache control	Always enabled
2st level cache control	Always enabled
Cache scheme control	Fixed in write-back

## System Memory

Item	Specification
Memory controller	Built-in Intel® 945GM/PM (for TravelMate 3250) Built-in Intel® 910GML (for TravelMate 2470)
Memory size	0MB (no on-board memory)
DIMM socket number	2 sockets
Supports memory size per socket	1024MB
Supports maximum memory size	2GB (by two 1024MB SO-DIMM modules) TravelMate 3250 4GB (by two 2048MB SO-DIMM modules) TravelMate 2470
Supports DIMM type	DDR 2 Synchronous DRAM
Supports DIMM Speed	533/677 MHz
Supports DIMM voltage	1.8V and 0.9V
Supports DIMM package	200-pin soDIMM
Memory module combinations	You can install memory modules in any combinations as long as they match the above specifications.

## Memory Combinations

Slot 1	Slot 2	Total Memory
0MB	256MB	256MB
0MB	512MB	512MB
0MB	1024MB	1024MB
0MB	2048MB	2048MB
256MB	0MB	256MB
256MB	256MB	512MB
256MB	512MB	768MB
256MB	1024MB	1280MB
256MB	2048MB	2304MB
512MB	0MB	512MB
512MB	256MB	768MB
512MB	512MB	1024MB
512MB	1024MB	1536MB
512MB	2048MB	2560MB
1024MB	0MB	1024MB
1024MB	256MB	1280MB
1024MB	512MB	1536MB
1024MB	1024MB	2048MB
1024MB	2048MB	3072MB
2048MB	0MB	2048MB
2048MB	256MB	2304MB
2048MB	512MB	2560MB
2048MB	1024MB	3072MB
2048MB	2048MB	4096MB

**NOTE:** Above table lists some system memory configurations. You may combine DIMMs with various capacities to form other combinations. On above table, the configuration of slot 1 and slot 2 could be

reversed.

### LAN Interface

Item	Specification
Chipset	Realtek 8110 or 8110CL
Supports LAN protocol	10/100Mbps
LAN connector type	RJ45
LAN connector location	Right side
Features	Integrated 10/100 BASE-T transceiver Wake on LAN support compliant with ACPI 2.0 PCI v2.2

### Modem Interface

Item	Specification
Data modem data baud rate (bps)	56K
Supports modem protocol	V.92
Modem connector type	RJ11
Modem connector location	Right side

### Bluetooth Interface

Item	Specification
Chipset	Built-in Intel® ICH7M
Data throughput	723 bps (full speed data rate)
Protocol	Bluetooth 1.1 (Upgradeable to Bluetooth 1.2 when SIG specification is ratified).
Interface	USB 1.1
Connector type	Mini-USB

Note: For more details, please see the table below.

Class	Power (mW)	Power (dBm)DeciBels below 1 Milliwatt	Range (approximate)
Class 1	100 mW	20 dBm	~100 meters
Class 2	2.5 mW	4 dBm	~10 meters
Class 3	1 mW	0 dBm	~1 meter

### Wireless Module 802.11b/g (optional device)

Item	Specification
Chipset	Built-in Intel® ICH7M
Data throughput	11~54 Mbps
Protocol	802.11b+g
Interface	PCI bus

### Hard Disk Drive Interface

Item			
Vendor & Model Name	WD WD400UE-22HCT0	WD WD600UE-22HCT0	SEAGATE ST98823A Samsung MP0804H WD WD800UE-22HCT0



### Hard Disk Drive Interface

Item			
Capacity (MB)	40000	60000	80000
Bytes per sector	512	512	512
Data heads	2	3	4 (for Samsung/WD) 3 (for Seagate)
Drive Format			
Disks	1	2	2
Spindle speed (RPM)	4200 RPM	5400 RPM	5400 RPM
Performance Specifications			
Buffer size	2048KB	2MB	8MB
Interface	ATA/ATAPI-6; ATA-6	ATA/ATAPI-6; ATA-6	ATA/ATA-6; ATA-6
Max. media transfer rate (disk-buffer, Mbytes/s)	372	350	350
Data transfer rate (host-buffer, Mbytes/s)	100 MB/Sec. Ultra DMA mode-5	100 MB/Sec. Ultra DMA mode-5	100 MB/Sec. Ultra DMA mode-5
DC Power Requirements			
Voltage tolerance	5V(DC) +/- 5%	5V(DC) +/- 5%	5V(DC) +/- 5%

### Combo Drive Interface

Item	Specification	
Vendor & model name	HLDS GCC-4244N Philips SCB5265 Panasonic UJDA770	
Performance Specification	With CD Diskette	With DVD Diskette
Transfer rate (KB/sec)	Sustained: Max 3.6Mbytes/sec	Sustained: Max 10.8Mbytes/sec
Buffer Memory	2MB	
Interface	Enhanced IDE(ATAPI) compatible	

## Combo Drive Interface

Item	Specification
Applicable disc format	<p><b>For HDLS GCC-4244N:</b></p> <ol style="list-style-type: none"> <li>1. Reads and writes data in each CD-ROM, CD-ROMXA, CD-I FMV, Video CD and CD-EXTRA</li> <li>2. Reads data in Photo CD (Single and multi session)</li> <li>3. Reads and writes standard CD-DA</li> <li>4. Reads and writes CD-R discs conforming to "Orange Book Part 2"</li> <li>5. Reads and writes CD-RW discs conforming to "Orange Book Part 3"</li> <li>6. Reads data in DVD-ROM</li> </ol> <p><b>For Philips SB5265:</b></p> <p>Applicable DVD formats (Read):            DVD: DVD-ROM, (DVD-5, DVD-9, DVD-10, DVD-18), DVD-Video, DVD-R 3.95G, DVD-R 4.7G, DVD-RW, DVD+R, DVD+RW, Multi-Border DVD-R/DVD-RW, Multi-session DVD+R, DVD+RW and DVD-RAM (optional)</p> <p>Applicable CD Formats (Read):            CD: CD-DA, CD-ROM Mode-1, CD-ROM/XA Mode Mode-2 Form-1 and Mode-2 Form-2, CD-i Ready, Video-CD (MPEG-1), Karaoke CD, Super Video CD, Photo-CD, Enhanced CD, CD Plus, CD Extra, i-trax CD, CD-Text, CD-R, CD-RW</p> <p>Applicable CD Formats (Write)            CD-DA, CD-ROM Mode-1, CD-ROM/XA Mode-2 Form-1 and Mode-2 Form-2, CD-i, Video-CD CD-Text</p> <p><b>For Panasonic UJDA770:</b></p> <p>CD: CD-DA, CD-ROM, CD-R, CD-RW, CD-ROM XA, Photo CD (Multi session), Video CD, CD-Extra (CD+), CD-text</p> <p>DVD: DVD-ROM, DVD-Video, DVD-RAM (2.6GB/4.7GB), DVD-R, DVD-RW (ver. 1.1) (Supporting Multi Border) DVD+R, DVD+RW (Supporting Multi Session)</p>
Loading mechanism	<p>Load: Manual</p> <p>Release: (a) Electrical Release (Release Button)            (b) Release by ATAPI command            (c) Emergency Release</p>
Power Requirement	
Input Voltage	5 V +/- 5 % (Operating)

## DVD-Super Multi Interface

Item	Specification	
Vendor & model name	HLDS GMA-4082N PIONEER DVR-K16RA	
Performance Specification	With CD Diskette	With DVD Diskette
Transfer rate (KB/sec)	Sustained: Max 3.6Mbytes/sec	Sustained: Max 10.08Mbytes/sec Max 11.08Mbytes/sec (for HLDS GMA-4082N)
Buffer Memory	2MB	
Interface	Enhanced IDE(ATAPI) compatible	

## DVD-Super Multi Interface

Item	Specification
Applicable disc format	<p><b>For HLDS GMA-4082N:</b> Support disc formats</p> <ol style="list-style-type: none"> <li>1. Reads data in each DVD-ROM, DVD-R (Ver. 1.0, Ver.2.0 for Authoring) and DVD-RAM (Ver1.0).</li> <li>2. Reads and writes in each DVD-R (Ver. 2.1 for General), DVD-R DL (Dual Layer), DVD-RW, DVD-RAM (Ver.2.2), DVD+R, DVD+R DL (Double Layer), and +RW</li> <li>3. Reads data in each CD-ROM, CD-ROM XA, CD-I, Video CD, CD-Extra and CD-Text</li> <li>4. Reads data in Photo CD (Single and Multi session)</li> <li>5. Reads standard CD-DA</li> <li>6. Support to read Super Audio CD (Compatible layer in Hybrid type)</li> <li>7. Reads and writes CD-R discs conforming to "Orange Book Part 2"</li> <li>8. Reads and writes CD-RW discs conforming to "Orange Book Part 3"</li> <li>9. CPRM (DVD-R/RW/RAM) supported</li> </ol> <p><b>For Pioneer DVR-K16RA</b> KODAK Photo CD Single and Multi-session, CD extra (CD PLUS), Video CD, CD text data (Read/Write), CD-R discs (Read/Write), CD-RW discs (Read/Write), DVD-ROM, DVD-R Ver.2.00 for general (Read/Write), DVD-R DL Ver 3.0 (Read/Write), DVD-RW Ver.1.0, 1.1 and 1.2 (Read/Write), DVD+R Ver.1.0, 1.11 and 1.2 (Read/Write), DVD+R DL Ver. 1.0 (Read/Write), DVD+RW Ver. 1.1 and 1.2(Read/Write), DVD+RW high speed Ver.1.0 (Read/Write), DVD-RAM Ver. 2.0&amp;2.1&amp;2.2 (Read/Write)</p>
Loading mechanism	<p>Load: Manual Release: (a) Electrical Release (Release Button) (b) Release by ATAPI command (c) Emergency Release</p>
Power Requirement	
Input Voltage	5 V +/- 5 % (Operating)

## Audio Interface

Item	Specification
Audio Controller	Realtek ALC833 (Audio amplifier Maxim MAX4411 for line-out port, G1432Q for speaker)
Audio onboard or optional	Built-in
Mono or Stereo	Stereo
Resolution	18 bit stereo full duplex
Compatibility	HD audio Interface; S/PDIF output for PCM or AC-3 content
Sampling rate	1Hz resolution VSR (Variable Sampling Rate)
Internal microphone	Yes
Internal speaker / Quantity	Yes/2 (1W speakers)

## Video Interface

Item	Specification
Chipset	ATI Radeon X1300 (for TravelMate 3250 discrete models) Built-in Intel® 945GM (for TravelMate 3250 UMA models) Built-in Intel® 910GML (for TravelMate 2470)
Package	Socket 775 and Socket 478 processors supported
Interface	internal PCIE
Supports ZV (Zoomed Video) port	Yes

## Video Memory

Item	Specification
Chipset	ATI Radeon X1300 (for TravelMate 3250 discrete models) Built-in Intel® 945GM (for TravelMate 3250 UMA models) Built-in Intel® 910GML (for TravelMate 2470)
Memory size	128MB dedicated memory->ATI Radeon X1300 (for TravelMate 3250 discrete models) 224 shared system memory->Built-in Intel® 945GM (for TravelMate 3250 UMA models) 224MB shared system memory->Built-in Intel® 910GML (for TravelMate 2470)
Interface	DDR2

## USB Port

Item	Specification
Chipset	Built-in Intel® ICH7M
USB Compliancy Level	2.0
OHCI	USB 1.1 and USB 2.0 Host controller
Number of USB port	3
Location	One on the front side/two on the right side
Serial port function control	Enable/Disable by BIOS Setup

## PCMCIA Port

Item	Specification
PCMCIA controller	ENE CB1410
Supports card type	Type-II
Number of slots	One type-II
Access location	Right panel
Supports ZV (Zoomed Video) port	No ZV support
Supports 32 bit CardBus	Yes

## System Board Major Chips

Item	Controller
Core logic	Intel® 945GM/PM+ICH7M Intel® 940GML+ICH7M
VGA	ATI Radeon X1300 (for TravelMate 3250 discrete models) Built-in Intel® 945GM (for TravelMate 3250 UMA models) Built-in Intel® 910GML (for TravelMate 2470)
LAN	RealTek 8100 or 8110CL
USB 2.0	Built-in Intel® ICH7M
Super I/O controller	NS87381
MODEM	Realtek ALC833
Bluetooth	Built-in Intel® ICH7M
Wireless 802.11 b+g	Built-in Intel® ICH7M

## System Board Major Chips

Item	Controller
PCMCIA	ENE CB1410
Audio Codec	Realtek ALC833
Card Reader (for Aspire 5500 only)/IEEE1394	RICOH R5C382

## Keyboard

Item	Specification
Keyboard controller	Renesas RE144B
Total number of keypads	88-/89-key
Windows logo key	Yes
Internal & external keyboard work simultaneously	Plug USB keyboard to the USB port directly: Yes

## Battery

Item	Specification
Vendor & model name	Sanyo (6cell) 2.0 Sony (6cell) 2.0 Panasonic (6cell) 2.0 SMP (6cell) 2.0 Snayo (6cell) 2.4 Sony (6cell) 2.4 Panasonic (6cell)2.4 Sanyo (9cell) 2.4
Battery Type	Li-ion
Pack capacity	4000 mAH forSanyo (6cell) 2.0 4000 mAH Sony (6cell) 2.0 4000 mAH Panasonic (6cell) 2.0 4800 mAH Snayo (6cell) 2.4 4800 mAH Sony (6cell) 2.4 4800 mAH Panasonic (6cell)2.4 Sanyo (9cell) 2.4
Number of battery cell	6/9
Package configuration	3 cells in series, 2 series in parallel 3 cells in series, 3 series in parallel
Normal voltage	14.8V
Charge voltage	16.8+-0.2v

## LCD 14.1" inch

Item	Specification		
Vendor & model name	QDI QD14TL01-02 QDI QD14TL01-03	CMO N14111-L02	SAMSUNG LTN141W1-L03
Screen Diagonal (mm)	14.1 inches	14.1 inches	14.1 inches
Active Area (mm)	303.7x189.8	303.36x189.6	303.36x189.6
Display resolution (pixels)	1280x800 WXGA	1280x800 WXGA	1280x800 WXGA
Pixel Pitch	0.237x0.237	0.237x0.237	0.237x0.237
Pixel Arrangement	R.G.B. Vertical Stripe	R.G.B. Vertical Stripe	R.G.B. Vertical Stripe
Display Mode	Normally White	Normally White	Normally White

### LCD 14.1" inch

Item	Specification		
Typical White Luminance (cd/m <sup>2</sup> ) also called Brightness	185	185	200
Luminance Uniformity	N/A	N/A	N/A
Contrast Ratio	300	500	300
Response Time (Optical Rise Time/Fall Time)msec	25 (rising+falling)	5/11	25 (rising+falling)
Nominal Input Voltage VDD	+2.5V Typ.	+3.3V	3.3V
Typical Power Consumption (watt)	N/A	4.02 (for backlight unit only)	N/A
Weight	420 (440max)	425	425
Physical Size(mm)	320x206x5.5	319.5x205.5x5.2	319.5x205.5x5.3
Electrical Interface	1 channel LVDS	1 channel LVDS	1 channel LVDS
Support Color	262,144	262,144	262,144
Viewing Angle (degree) Horizontal: Right/Left Vertical: Upper/Lower	40/40 15/30	45/45 20/45	45/45 15/30
Temperature Range(° C) Operating Storage (shipping)	0 to +50 -20 to +60	0 to +50 -25 to +60	0 to +50 -20 to +60

### LCD 14.1" inch

Item	Specification	
Vendor & model name	LG LP141WX1-TL02	AUO B141EW01 V1
Screen Diagonal (mm)	14.1 inches	14.1 inches
Active Area (mm)	305.8x183.2	303.36x189.6
Display resolution (pixels)	1280x800 WXGA	1280x800 WXGA
Pixel Pitch	0.237x0.237	0.237x0.237
Pixel Arrangement	R.G.B. Vertical Stripe	R.G.B. Vertical Stripe
Display Mode	Normally White	Normally White
Typical White Luminance (cd/m <sup>2</sup> ) also called Brightness	185	200
Luminance Uniformity	N/A	N/A
Contrast Ratio	300	350
Response Time (Optical Rise Time/Fall Time)msec	25 (rising+falling)	25
Nominal Input Voltage VDD	+3.3V Typ.	+3.3V
Typical Power Consumption (watt)	N/A	5.6watt @ LCM circuit 1.6 Watt (max), backlight input 4.2Watt (typ)
Weight	420 (440max)	425
Physical Size(mm)	320.0x317.3x242.0x6.0	320x206x5.5
Electrical Interface	1 channel LVDS	1 channel LVDS
Support Color	262,144	262,144
Viewing Angle (degree) Horizontal: Right/Left Vertical: Upper/Lower	40/40 10/30	45/45 20/35

## LCD 14.1" inch

Item	Specification	
Temperature Range(° C)		
Operating	0 to +50	0 to +50
Storage (shipping)	-20 to +60	-25 to +60

## LCD Inverter

Item	Specification
Vendor & model name	Darfon/V189-301GP
Brightness conditions	N/A
Input voltage (V)	9~21
Input current (mA)	2.56 (max)
Output voltage (V, rms)	780V (2000V for kick off)
Output current (mA, rms)	6.5 (max)
Output voltage frequency (k Hz)	65K Hz (max)

## AC Adaptor

Item	Specification
Input rating	90V AC to 264V AC, 47Hz to 63Hz
Maximum input AC current	1.7A
Inrush current	220A@115VAC 220A@230VAC
Efficiency	82% min. @115VAC input full load

## System Power Management

ACPI mode	Power Management
Mech. Off (G3)	All devices in the system are turned off completely.
Soft Off (G2/S5)	OS initiated shutdown. All devices in the system are turned off completely.
Working (G0/S0)	Individual devices such as the CPU and hard disc may be power managed in this state.
Suspend to RAM (S3)	CPU set power down VGA Suspend PCMCIA Suspend Audio Power Down Hard Disk Power Down CD-ROM Power Down Super I/O Low Power mode
Save to Disk (S4)	Also called Hibernation Mode. System saves all system states and data onto the disc prior to power off the whole system.





## System Utilities

### BIOS Setup Utility

The BIOS Setup Utility is a hardware configuration program built into your computer's BIOS (Basic Input/Output System).

Your computer is already properly configured and optimized, and you do not need to run this utility. However, if you encounter configuration problems, you may need to run Setup. Please also refer to Chapter 4 Troubleshooting when problem arises.

To activate the BIOS Utility, press **F2** during POST (when "Press <F2> to enter Setup" message is prompted on the bottom of screen).

Press **F2** to enter setup. The default parameter of F12 Boot Menu is set to "disabled". If you want to change boot device without entering BIOS Setup Utility, please set the parameter to "enabled".

Press <F12> during POST to enter multi-boot menu. In this menu, user can change boot device without entering BIOS SETUP Utility.

PhoenixBIOS Setup Utility					
Information	Main	Advanced	Security	Boot	Exit
CPU Type :	Intel (R) Pentium (R) M processor 1.60GHz				
CPU Speed :	1600MHz				
HDD Model Name :	ST96812A - (PM)				
HDD Serial Number :	PIONEER DVD-RW DVR-K16RA				
ATAPI Model Name :	None				
ATAPI Serial Number :	None				
System BIOS Ver:	V0.05				
VGA BIOS Ver	1227				
KBC Ver	01.00				
Serial Number	xxxxxxxxxxxxxxxxxxxxxxxxxxxx				
Asset Tag Number	N/A			22 Byte	
Produce Name	Aspire 3620/TravelMate 2420			32 Byte	
Manufacturer Name:	Acer			16 Byte	
UUID:	xxxxxxxxxxxxxxxxxxxxxxxxxxxx			16 Byte	
				32 Byte	
F1 Help	↑↓ Select Item	F5/F6 Change Values	F9 Setup Defaults		
Esc Exit	←→ Select Menu	Enter Select	▶ Sub-Menu	F10 Save and Exit	

---

## Navigating the BIOS Utility

There are six menu options: Info., Main, System Devices, Security, Boot, and Exit.

Follow these instructions:

- ❑ To choose a menu, use the cursor left/right keys (← →).
- ❑ To choose a parameter, use the cursor up/down keys (↑ ↓).
- ❑ To change the value of a parameter, press F8 or F6.
- ❑ A plus sign (+) indicates the item has sub-items. Press ENTER to expand this item.
- ❑ Press ESC while you are in any of the menu options to go to the Exit menu.
- ❑ In any menu, you can load default settings by pressing F8. You can also press F6 to save any changes made and exit the BIOS Setup Utility.

**NOTE:** You can change the value of a parameter if it is enclosed in square brackets. Navigation keys for a particular menu are shown on the bottom of the screen. Help for parameters are found in the Item Specific Help part of the screen. Read this carefully when making changes to parameter values. **Please note that system information is subject to different models.**

# Information

PhoenixBIOS Setup Utility					
Information	Main	Advanced	Security	Boot	Exit
CPU Type :	Intel (R) Pentium (R) M processor 1.60GHz				
CPU Speed :	1600MHz				
HDD Model Name :	ST96812A - (PM)				
HDD Serial Number :	PIONEER DVD-RW DVR-K16RA				
ATAPI Model Name :	None				
ATAPI Serial Number :	None				
System BIOS Ver:	V0.05				
VGA BIOS Ver	1227				
KBC Ver	01.00				
Serial Number	xxxxxxxxxxxxxxxxxxxxxxxx				
Asset Tag Number	N/A				22 Byte
Produce Name	Aspire 3620/TravelMate 2420				32 Byte
Manufacturer Name:	Acer				16 Byte
UUID:	xxxxxxxxxxxxxxxxxxxxxxxx				16 Byte
					32 Byte

F1 Help	↑↓ Select Item	F5/F6 Change Values	F9 Setup Defaults
Esc Exit	←→ Select Menu	Enter Select ▶ Sub-Menu	F10 Save and Exit

**NOTE:** The system information is subject to different models.

Parameter	Description
CPU Type	This field shows the CPU type and speed of the system.
IDE1 Model Name	This field shows the model name of HDD installed on primary IDE master.
IDE1 Serial Number	This field displays the serial number of HDD installed on primary IDE master.
IDE2I Model Name	This field displays the mofel name of devices installed on secondary IDE master. The hard disk drive or optical drive model name is automatically detected by the system.
IDE2 Serial Number	This field shows the serial number of devices installed on secondary IDE master.
System BIOS ver	Displays system BIOS version.
VGA BIOS Ver	This field displays the VGA firmware version of the system.
KBC Ver	This field shows the keyboard
Serial Number	This field displays the serial number of this unit.
Asset Tag Number	This field displays the asset tag number of the system.
Product Name	This field shows product name of the system.
Manufacturer Name	This field displays the manufacturer of this system.
UUID Number	This will be visible only when an internal LAN device is presenting. UUID=32bytes

# Main

The Main screen displays a summary of your computer hardware information, and also includes basic setup parameters. It allows the user to specify standard IBM PC AT system parameters.

PhoenixBIOS Setup Utility					
Information	Main	Advanced	Security	Boot	Exit
					Item Specific Help
System Time:	[20:03:49]				<Tab>, <Shift-Tab>, or <Enter> selects field.
System Date:	[06/05/2006]				
System Memory:	640 KB	Shows system base memory size			
Extended Memory:	XXX	Shows extended memory size			
Video Memory	[128MB]	VGA memory size			
Quiet Boot:	[Enabled]				
Power on display:	[Auto ]				
Network boot	[Enabled]				
F12 Boot Menu	[Disabled]				
D2D Recovery	[Enabled]				
F1 Help	↑↓ Select Item	F5/F6 Change Values	F9 Setup Defaults		
Esc Exit	←→ Select Menu	Enter Select	▶ Sub-Menu	F10 Save and Exit	

**NOTE:** The screen above is for your reference only. Actual values may differ.

The table below describes the parameters in this screen. Settings in **boldface** are the default and suggested parameter settings.

Parameter	Description	Format/Option
System Time	Sets the system time. The hours are displayed with 24-hour format.	Format: HH:MM:SS (hour:minute:second) System Time
System Date	Sets the system date.	Format MM/DD/YYYY (month/day/year) System Date
System Memory	This field reports the memory size of the system. Memory size is fixed to 640MB	
Extended Memory	This field reports the memory size of the extended memory in the system. Extended Memory size=Total memory size-1MB	
VGA Memory	Shows the VGA memory size. VGA Memory size=64/128MB	
Quiet Boot	Determines if Customer Logo will be displayed or not; shows Summary Screen is disabled or enabled.  Enabled: Customer Logo is displayed, and Summary Screen is disabled.  Disabled: Customer Logo is not displayed, and Summary Screen is enabled.	Option: <b>Enabled</b> or Disabled
Power on display	Auto: During power process, the system will detect if any display device is connected on external video port. If any external display device is connected, the power on display will be in CRT (or projector) only mode. Otherwise it will be in LCD only mode.  Both: Simultaneously enable both the integrated LCD screen and the system's external video port (for an external CRT or projector).	Option: <b>Auto</b> or Both
Network Boot	Enables, disables the system boot from LAN (remote server).	Option: <b>Enabled</b> or Disabled
F12 Boot Menu	Enables, disables Boot Menu during POST.	Option: <b>Disabled</b> or Enabled
D2D Recovery	Enables, disables D2D Recovery function. The function allows the user to create a hidden partition on hard disc drive to store operation system and restore the system to factory defaults.	Option: <b>Enabled</b> or Disabled

**NOTE:** The sub-items under each device will not be shown if the device control is set to disable or auto. This is because the user is not allowed to control the settings in these cases.

# Advanced

The Advanced screen displays advanced settings in BIOS.

PhoenixBIOS Setup Utility		
Information	Main	Advanced
Serial Port	[Auto]	Item Specific Help Configure Infrared Port using options: [Disable] No configuration [Enabled] User configuration [Auto] BIOS or OS chooses configuration (OS Controlled) Displayed when controlled by OS
Parallel port: Mode	[Auto] [ECP]	
Infrared port (FIR):	[Enabled]	
F1 Help      ↑ ↓ Select Item      F5/F6 Change Values      F9 Setup Defaults Esc Exit      ← → Select Menu      Enter Select ▶ Sub-Menu      F10 Save and Exit		

The table below describes the parameters in this screen. Settings in **boldface** are the default and suggested parameter settings.

Parameter	Description	Option
Serial port	Displays the settings of the serial prot	<b>Auto</b> /Enabled/ Disabled
Parallel port	Shows the settings of the parallel port	<b>Auto</b> /Enabled/ Disabled
IrDA Device	Shows the setting of the infrared port	<b>Auto</b> /Enabled/ Disabled

# Security

The Security screen contains parameters that help safeguard and protect your computer from unauthorized use.

PhoenixBIOS Setup Utility					
Information	Main	Advanced	Security	Boot	Exit
Supervisor Password is : Clear User Password is : Clear HDD Password is : Clear  Set Supervisor Password [Enter] Set User Password [Enter] Set HDD Password [Enter]  Password on Boot [Disabled]					<b>Item Specific Help</b>  Supervisor Password controls accesses of the whole setup utility. It can be used to boot up when Password on boot is enabled.
F1 Help	↑ ↓	Select Item	F5/F6	Change Values	F9 Setup Defaults
Esc Exit	← →	Select Menu	Enter	Select ▶ Sub-Menu	F10 Save and Exit

The table below describes the parameters in this screen. Settings in **boldface** are the default and suggested parameter settings.

Parameter	Description	Option
User Password is	Shows the setting of the user password.	<b>Clear</b> or Set
Supervisor Password is	Shows the setting of the Supervisor password	<b>Clear</b> or Set
Set User Password	Press Enter to set the user password. When user password is set, this password protects the BIOS Setup Utility from unauthorized access. The user can enter Setup menu only and does not have right to change the value of parameters.	
Set Supervisor Password	Press Enter to set the supervisor password. When set, this password protects the BIOS Setup Utility from unauthorized access. The user can not either enter the Setup menu nor change the value of parameters.	
Primary HardDisk Security	Enables or disables primary hard disk security function.	
Password on Boot	Defines whether a password is required or not while the events defined in this group happened. The following sub-options are all requires the Supervisor password for changes and should be grayed out if the user password was used to enter setup.	<b>Disabled</b> or Enabled

**NOTE:** When you are prompted to enter a password, you have three tries before the system halts. Don't forget your password. If you forget your password, you may have to return your notebook computer to your dealer to reset it.

## Setting a Password

Follow these steps as you set the user or the supervisor password:

1. Use the **↑** and **↓** keys to highlight the Set Supervisor Password parameter and press the **ENTER** key. The Set Supervisor Password box appears:

Set Supervisor Password

Enter New Password [                    ]

Confirm New Password [                    ]

2. Type a password in the "Enter New Password" field. The password length can not exceeds 8 alphanumeric characters (A-Z, a-z, 0-9, not case sensitive). Retype the password in the "Confirm New Password" field.

**IMPORTANT:** Be very careful when typing your password because the characters do not appear on the screen.

3. Press **ENTER**.
4. After setting the password, the computer sets the User Password parameter to "Set".
4. If desired, you can opt to enable the Password on boot parameter.
5. When you are done, press **F10** to save the changes and exit the BIOS Setup Utility.



---

## Removing a Password

Follow these steps:

1. Use the **↑** and **↓** keys to highlight the Set Supervisor Password parameter and press the **ENTER** key. The Set Password box appears:

Set Supervisor Password		
Enter current password	[	]
Enter New Password	[	]
Confirm New Password	[	]

2. Type the current password in the Enter Current Password field and press **ENTER**.
3. Press **ENTER** twice **without** typing anything in the Enter New Password and Confirm New Password fields. The computer then sets the Supervisor Password parameter to "Clear".
4. When you have changed the settings, press **F10** to save the changes and exit the BIOS Setup Utility.

## Changing a Password

1. Use the **↑** and **↓** keys to highlight the Set Supervisor Password parameter and press the **ENTER** key. The Set Password box appears:

Set Supervisor Password		
Enter current password	[	]
Enter New Password	[	]
Confirm New Password	[	]

2. Type the current password in the Enter Current Password field and press **ENTER**.
3. Type a password in the Enter New Password field. Retype the password in the Confirm New Password field.
4. Press **ENTER**. After setting the password, the computer sets the User Password parameter to "Set".
5. If desired, you can enable the Password on boot parameter.
6. When you are done, press **F10** to save the changes and exit the BIOS Setup Utility.

If the verification is OK, the screen will display as following.

Setup Notice
Changes have been saved.
[ continue]

The password setting is complete after the user presses **F10**.

---

If the current password entered does not match the actual current password, the screen will show you the Setup Warning.

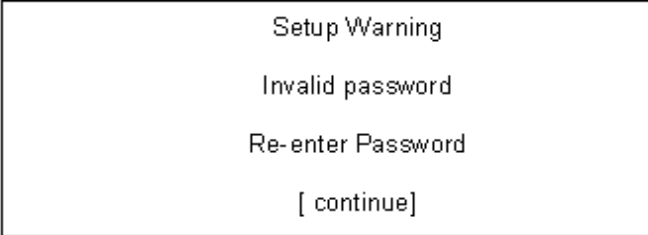

Setup Warning  
Invalid password  
Re-enter Password  
[ continue]

A rectangular dialog box with a black border containing four lines of text centered horizontally.

If the new password and confirm new password strings do not match, the screen will display the following message.

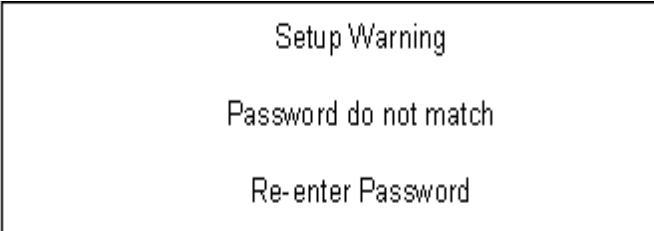

Setup Warning  
Password do not match  
Re-enter Password

A rectangular dialog box with a black border containing three lines of text centered horizontally.

## Boot

This menu allows the user to decide the order of boot devices to load the operating system. Bootable devices includes the distette drive in module bay, the onboard hard disk drive and the CD-ROM in module bay.

PhoenixBIOS Setup Utility					
Information	Main	Advanced	Security	Boot	Exit
Boot priority order: 1: IDE0: WDC WD200EB-(PM) 2: IDE1: Samsung CD-ROM 3: Boot 4. USB HDD 5. USB CD-ROM 6. USB Floppy 7. USB Key				Item Specific Help	
				Keys used to view or configure devices: <Enter> to expands or collapses devices with a + or - <F5> and <F6> moves the device up or down.	
F1 Help	↑↓ Select Item	F5/F6 Change Values	F9 Setup Defaults		
Esc Exit	←→ Select Menu	Enter Select	▶ Sub-Menu	F10 Save and Exit	

# Exit

The Exit screen contains parameters that help safeguard and protect your computer from unauthorized use.

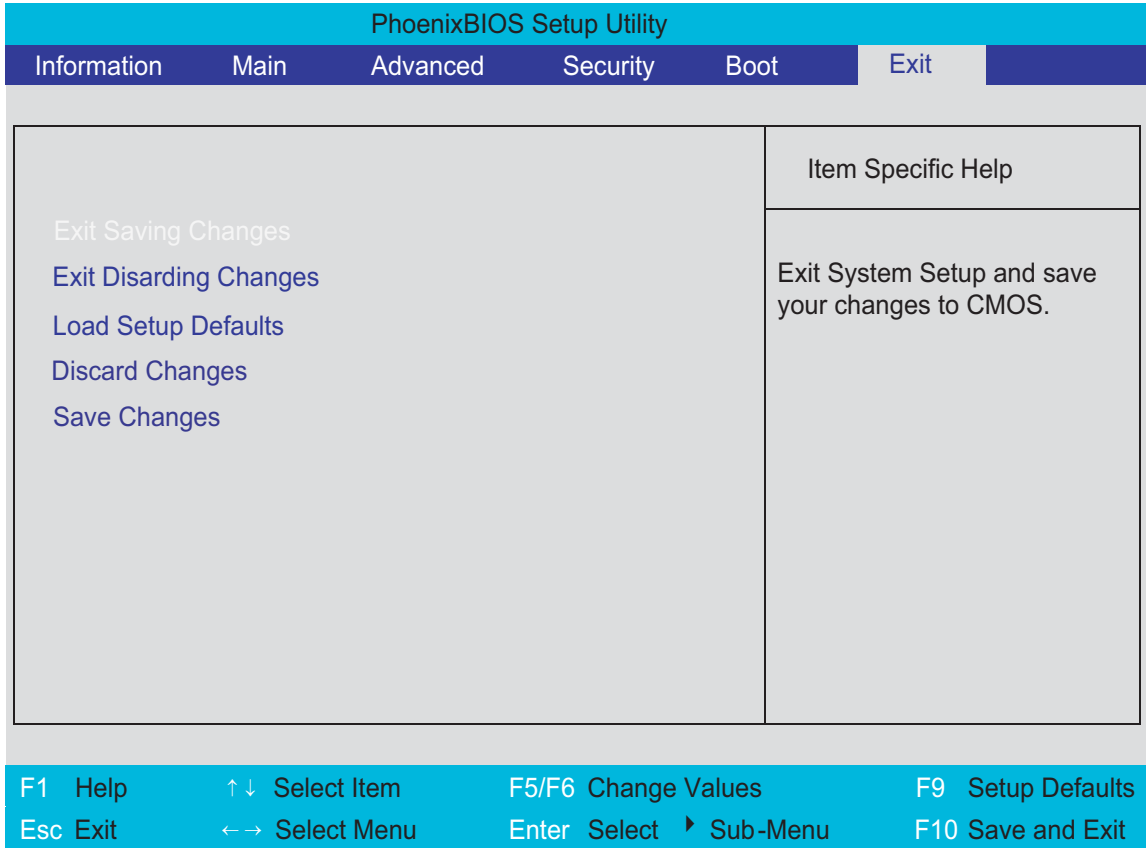

The table below describes the parameters in this screen.

Parameter	Description
Exit Saving Changes	Exit System Setup and save your changes to CMOS.
Exit Discarding Changes	Exit utility without saving setup data to CMOS.
Load Setup Default	Load default values for all SETUP item.
Discard Changes	Load previous values from CMOS for all SETUP items.
Save Changes	Save Setup Data to CMOS.

---

# BIOS Flash Utility

The BIOS flash memory update is required for the following conditions:

- New versions of system programs
- New features or options
- Restore a BIOS when it becomes corrupted.

Use the Phlash utility to update the system BIOS flash ROM.

**NOTE:** If you do not have a crisis recovery diskette at hand, then you should create a **Crisis Recovery Diskette** before you use the Phlash utility.

**NOTE:** Do not install memory-related drivers (XMS, EMS, DPMS) when you use the Phlash.

**NOTE:** Please use the AC adaptor power supply when you run the Phlash utility. If the battery pack does not contain enough power to finish BIOS flash, you may not boot the system because the BIOS is not completely loaded.

Follow the steps below to run the Phlash.

1. Prepare a bootable diskette.
2. Copy the flash utilities to the bootable diskette.
3. Then boot the system from the bootable diskette. The flash utility has auto-execution function.



# Machine Disassembly and Replacement

---

This chapter contains step-by-step procedures on how to disassemble the notebook computer for maintenance and troubleshooting.

To disassemble the computer, you need the following tools:

- Wrist grounding strap and conductive mat for preventing electrostatic discharge
- Small Philips screw driver
- Philips screwdriver
- Plastic flat head screw driver
- Tweezers

**NOTE:** The screws for the different components vary in size. During the disassembly process, group the screws with the corresponding components to avoid mismatch when putting back the components. When you remove the stripe cover, please be careful not to scrape the cover.

---

## General Information

### Before You Begin

Before proceeding with the disassembly procedure, make sure that you do the following:

1. Turn off the power to the system and all peripherals.
2. Unplug the AC adapter and all power and signal cables from the system.
3. Remove the battery pack.



# Disassembly Procedure Flowchart

The flowchart on the succeeding page gives you a graphic representation on the entire disassembly sequence and instructs you on the components that need to be removed during servicing. For example, if you want to remove the system board, you must first remove the keyboard, then disassemble the inside assembly frame in that order.

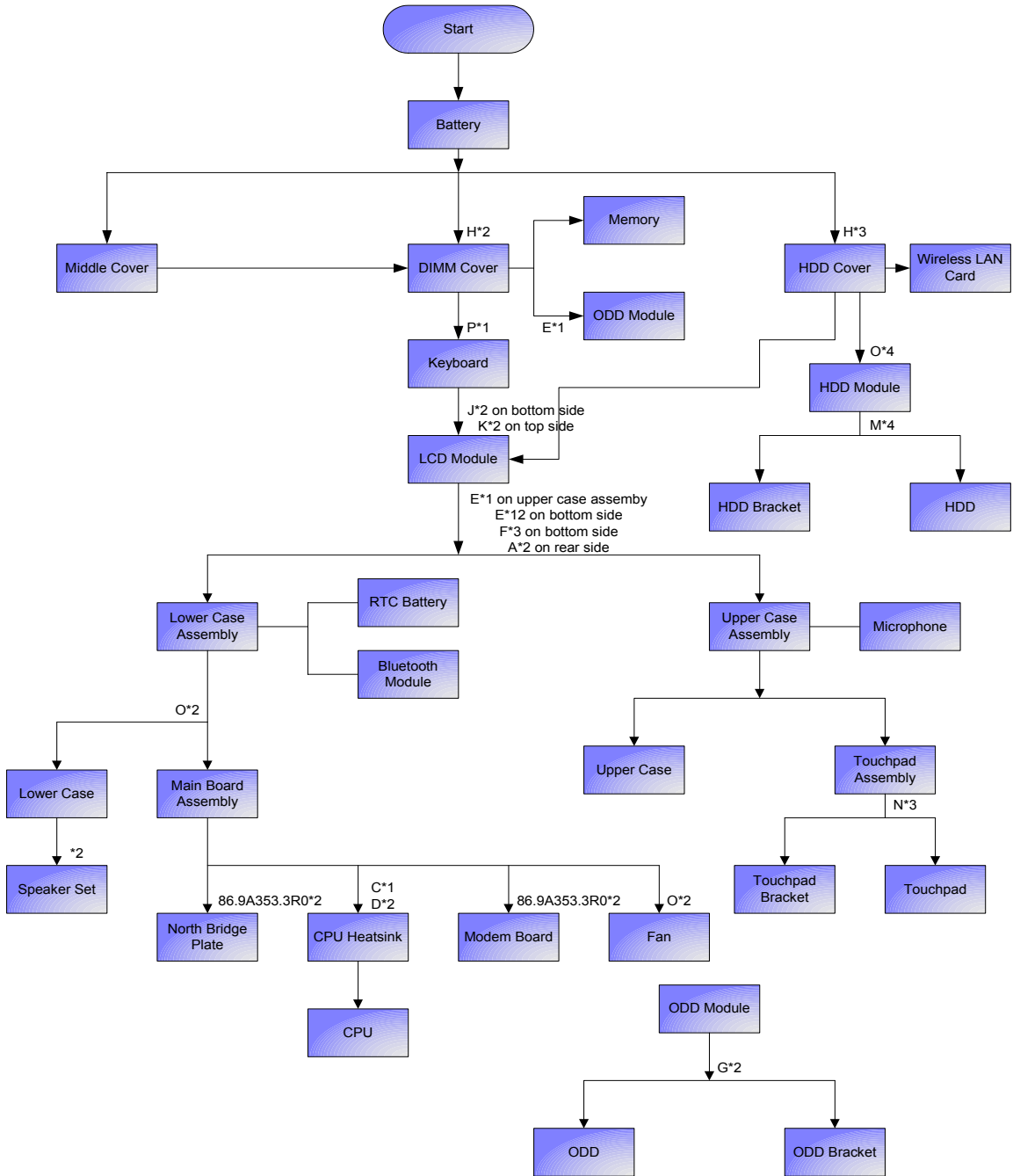

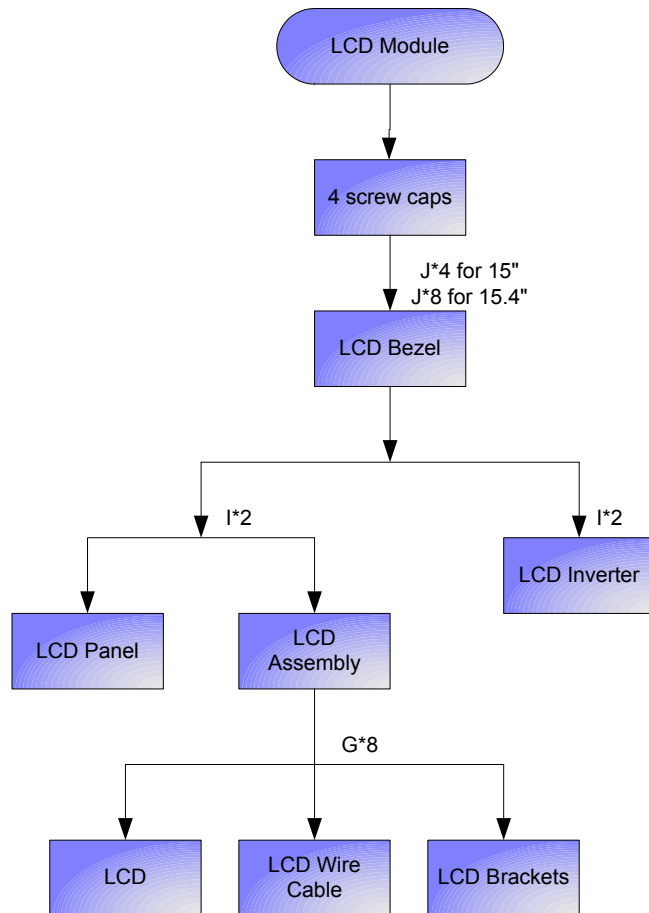

**Screw List**

Item	Description	Part Number
A	SCW HEX NYL I#R-40/O#4-40 L5.5	34.00015.081
B	SCREW MACH WAFER M2*L4 NI	86.00059.220 (PC Card slot x4)
C	CPU SCREW M2.5*4.3L (2.3 KG)	86.00D01.230
D	CPU SCREW M2.5*4.3L (1.55 KG)	86.00D02.230
E	SCREW M2.5-6	86.9A323.6R0
F	SCRW M2.5*L8(NON NYLOK)	86.9A323.8R0
G	SCREW M2*3 NYLON 1JMCPC-420325	86.9A352.3R0
H	SCREW	86.9A352.4R0
I	SCREW M2.5*4L(NYLOCK)BLACK ZN	86.9A353.4R0
J	SCREW M2.5X6	86.9A353.6R0
K	SRW M2.5*8L B/ZN NYLOK 700	86.9A353.8R0
L	SCRW M2.5*L3(NON NYLOK)	86.9A523.3R0
M	SCREW M3x4(86.9A524.4R0)	86.9A524.4R0
N	SCREW WAFER NYLOK NI 2ML3	86.9A552.3R0
O	SCRW M2*4 WAFER NI	86.9A552.4R0
P	SCRW M2.5*3 WAFER NI	86.9A553.3R0

---

## Removing the Battery Pack

1. Unlock the battery lock.
2. Slide the battery latch then remove the battery.



---

# Removing the Wireless LAN Card/the HDD Module/the Memory/the ODD Module and the LCD Module

## Removing the Memory and the HDD Module

1. Remove the five screws fastening the DIMM cover.
2. Detach the DIMM cover carefully.

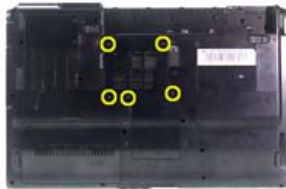

3. Pop out the memory carefully.
4. Disconnect wireless main and auxiliary antenna from the wireless LAN card.
5. Pop out the wireless LAN card and remove it.



6. Remove the three screws fastening the HDD cover.
7. Detach the HDD cover from the main unit.



8. Remove the four screws fastening the HDD module.
9. Then detach the HDD module carefully.



## Removing the ODD Module

1. First, remove the screw fastening the ODD module as shown.
2. Push the ODD module outwards then remove it.



## Removing the LCD Module

1. Detach the middle cover from the main unit carefully.
2. Disconnect the launch board FFC from the launch board.



3. Remove the middle cover (with launch board and microphone) from the main unit.
4. Disconnect the microphone cable from the launch board.



5. Take out the microphone from the middle cover.
6. Remove the two screws fastening the launch board.
7. Then remove the launch board from the middle cover.



8. Remove the screw holding the keyboard.
9. Turn over the keyboard as shown.
10. Disconnect the keyboard cable.



11. Remove the keyboard from the main unit.
12. Tear off the tapes fastening the wireless antenna cable.



13. Pull the antenna set from the main unit.
14. Disconnect the LCD cable.
15. Turn over the notebook then remove two screws fastening the LCD module.



16. Remove two screws fastening the LCD hinges.
17. Then detach the LCD module from the main unit.



---

## Disassembling the Main Unit

### Separate the Main Unit Into the Upper and the Lower Case Assembly

1. Disconnect the touchpad cable and the LED FFC from the main board.
2. Remove the 15 screws on the bottom as shown.
3. Detach the upper case assembly from the lower case assembly carefully.

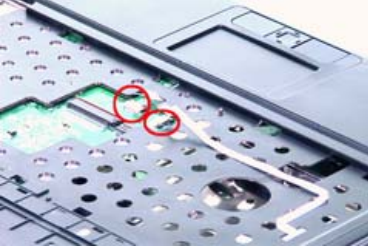

### Disassembling the Lower Case Assembly

4. Turn over the lower case assembly to the bottom side, then disconnect the fan cable.
5. Turn over the lower case assembly to the front side, then detach the bluetooth module.



6. Disconnect the Bluetooth cable from the main board.
7. Disconnect the Bluetooth cable from the Bluetooth module as shown.



8. Disconnect the speaker set cable from the main board.
9. Remove the four screws fastening the main board to the lower case.
10. Detach the main board from the lower case carefully.





11. Remove the two screws holding the speaker set.
12. Take out the speaker set from the lower case.



13. Remove the three screws fastening the system fan.
14. Detach the fan from the lower case.



15. Disconnect the RTC battery cable then detach the RTC battery.
16. Disconnect the launch board FFC from the main board.



17. Disconnect the modem cable from the main board.
18. Disconnect the modem board from the main board.
19. Disconnect the modem cable from the modem board as shown.

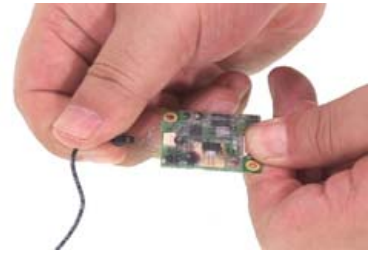

20. Remove the five screws fastening the heatsink.
21. Remove the heatsink from the main board.



22. Use a flat-headed screwdriver to release the CPU socket lock.
23. Remove the CPU from the CPU socket carefully.



## Disassembling the Upper Case Assembly

1. Remove the two screws fastening the LED board.
2. The remove the LED board from the upper case assembly carefully.

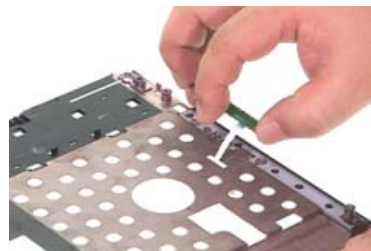
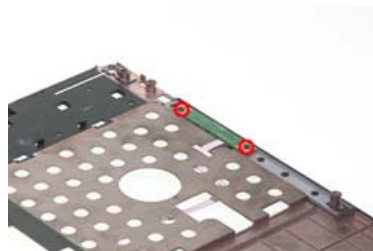

3. Disconnect the LED board FFC from the LED board.
4. Disconnect the touchpad FFC then remove it.

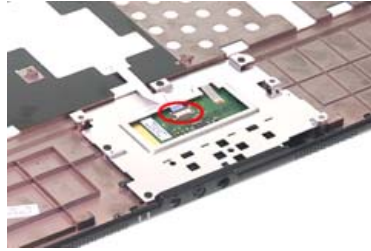

5. Remove the four screws fastening the touchpad bracket.
6. Remove the touchpad bracket (with touchpad).
7. Detach the touchpad from the touchpad bracket.

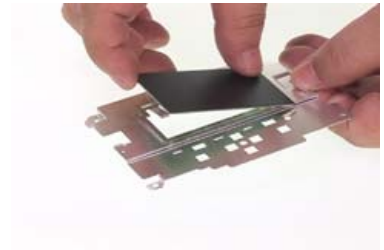
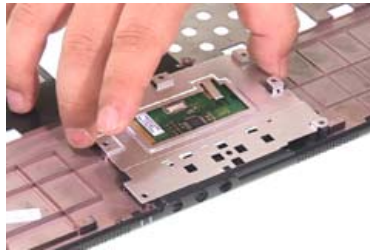
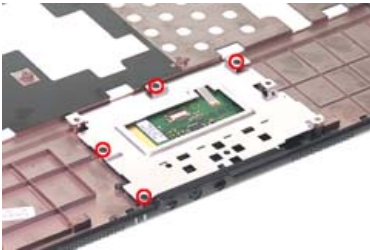

## Disassembling the LCD Module (with video camera)

1. Remove the four screw caps as shown.
2. Remove the four screws holding the LCD bezel.
3. Then detach the LCD bezel from the LCD module.



4. Remove the two screws fastening the LCD inverter.
5. Take out the LCD inverter from the LCD cover, then disconnect the LCD cable from the inverter.
6. Remove the two screws holding the digital camera to the LCD panel.

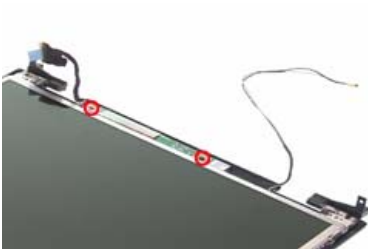

7. Detach the CCD panel from the CCD bezel assembly.
8. Disconnect digital camera to LCD cable as shown.
9. Remove the two screws fastening the CCD.

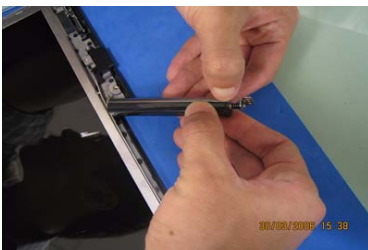

10. Take out the CCD from the CCD bezel.
  11. Then remove the CCD hinge from the CCD bezel.
  12. Slide the CCD latch to the right to remove the CCD latch.
- NOTE:** The edges of the CCD latch is very fragile, please practice this step very carefully.

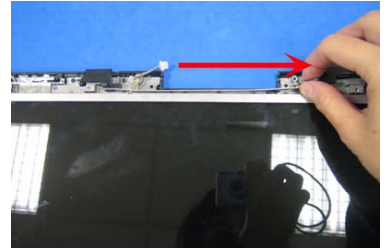
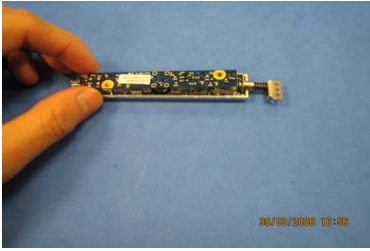

13. Take out the LCD assembly from the LCD panel.
14. Disconnect the LCD cable from the LCD.
15. Tear off the tape fastening the LCD cable and detach the LCD cable from the LCD.

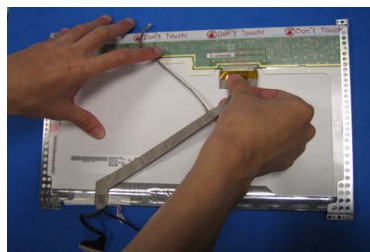

16. Remove the two screws holding the wireless antenna set to the LCD panel.
17. Take out the wireless antenna set from the LCD panel.
18. Remove the two screws holding the LCD hinges then remove the hinges.

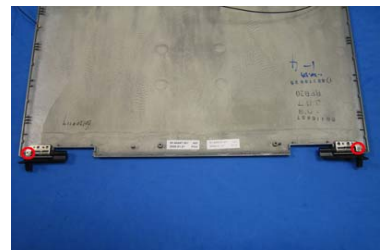

19. Remove the four screws fastening the LCD right bracket.
20. Remove the right bracket from the LCD.

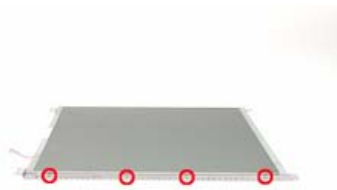

21. Remove the four screws fastening the LCD left bracket.
22. Remove the left bracket from the LCD.



---

## Disassembling the External Modules

### Disassembling the HDD Module

1. Remove the four screws fastening the HDD bracket.
2. Remove the HDD bracket.

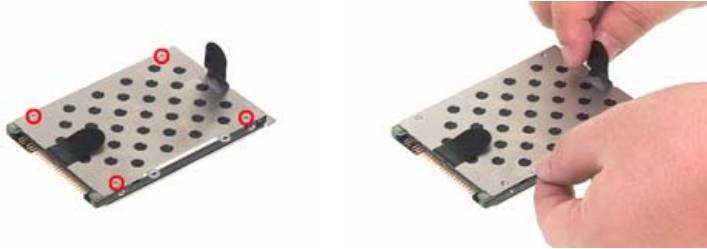

### Disassembling the ODD Module

1. Remove the two screws holding the ODD fix holder bracket.
2. Then remove the ODD fix holder bracket.
3. Remove the two screws fastening the ODD rail bracket then remove the rail bracket.





# Troubleshooting

Use the following procedure as a guide for computer problems.

**NOTE:** The diagnostic tests are intended to test only Acer products. Non-Acer products, prototype cards, or modified options can give false errors and invalid system responses.

1. Obtain the failing symptoms in as much detail as possible.
2. Verify the symptoms by attempting to re-create the failure by running the diagnostic test or by repeating the same operation.
3. Use the following table with the verified symptom to determine which page to go to.

Symptoms (Verified)	Go To
Power failure. (The power indicator does not go on or stay on.)	"Power System Check" on page 83.
POST does not complete. No beep or error codes are indicated.	"Power-On Self-Test (POST) Error Message" on page 86 "Undetermined Problems" on page 98
POST detects an error and displayed messages on screen.	"Error Message List" on page 87
Other symptoms (i.e. LCD display problems or others).	"Power-On Self-Test (POST) Error Message" on page 86
Symptoms cannot be re-created (intermittent problems).	Use the customer-reported symptoms and go to "Power-On Self-Test (POST) Error Message" on page 86 "Intermittent Problems" on page 97 "Undetermined Problems" on page 98

---

# System Check Procedures

## External Diskette Drive Check

Do the following to isolate the problem to a controller, driver, or diskette. A write-enabled, diagnostic diskette is required.

**NOTE:** Make sure that the diskette does not have more than one label attached to it. Multiple labels can cause damage to the drive or cause the drive to fail.

Do the following to select the test device.

1. Boot from the diagnostics diskette and start the diagnostics program.
2. See if FDD Test is passed as the program runs to FDD Test.
3. Follow the instructions in the message window.

If an error occurs with the internal diskette drive, reconnect the diskette connector on the system board.

If the error still remains:

1. Reconnect the external diskette drive/DVD-ROM module.
2. Replace the external diskette drive/CD-ROM module.
3. Replace the main board.

## External CD-ROM Drive Check

Do the following to isolate the problem to a controller, drive, or CD-ROM. Make sure that the CD-ROM does not have any label attached to it. The label can cause damage to the drive or can cause the drive to fail.

Do the following to select the test device:

1. Boot from the diagnostics diskette and start the diagnostics program.
2. See if CD-ROM Test is passed when the program runs to CD-ROM Test.
3. Follow the instructions in the message window.

If an error occurs, reconnect the connector on the System board. If the error still remains:

1. Reconnect the external diskette drive/CD-ROM module.
2. Replace the external diskette drive/CD-ROM module.
3. Replace the main board.

## Keyboard or Auxiliary Input Device Check

Remove the external keyboard if the internal keyboard is to be tested.

If the internal keyboard does not work or an unexpected character appears, make sure that the flexible cable extending from the keyboard is correctly seated in the connector on the system board.

If the keyboard cable connection is correct, run the Keyboard Test.

If the tests detect a keyboard problem, do the following one at a time to correct the problem. Do not replace a non-defective FRU:

1. Reconnect the keyboard cables.
2. Replace the keyboard.
3. Replace the main board.

The following auxiliary input devices are supported by this computer:

- Numeric keypad
- External keyboard

---

If any of these devices do not work, reconnect the cable connector and repeat the failing operation.

## Memory check

Memory errors might stop system operations, show error messages on the screen, or hang the system.

1. Boot from the diagnostics diskette and start the doagmpstotics program (please refer to main board).
2. Go to the diagnostic memory in the test items.
3. Press F2 in the test items.
4. Follow the instructions in the message window.

**NOTE:** Make sure that the DIMM is fully installed into the connector. A loose connection can cause an error.

## Power System Check

To verify the symptom of the problem, power on the computer using each of the following power sources:

1. Remove the battery pack.
2. Connect the power adapter and check that power is supplied.
3. Disconnect the power adapter and install the charged battery pack; then check that power is supplied by the battery pack.

If you suspect a power problem, see the appropriate power supply check in the following list:

- “Check the Power Adapter” on page 84
- “Check the Battery Pack” on page 85

---

## Check the Power Adapter

Unplug the power adapter cable from the computer and measure the output voltage at the plug of the power adapter cable. See the following figure

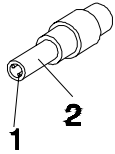

Pin 1: +19 to +20.5V  
Pin 2: 0V, Ground

1. If the voltage is not correct, replace the power adapter.
2. If the voltage is within the range, do the following:
  - Replace the System board.
  - If the problem is not corrected, see “Undetermined Problems” on page 98.
  - If the voltage is not correct, go to the next step.

**NOTE:** An audible noise from the power adapter does not always indicate a defect.

3. If the power-on indicator does not light up, check the power cord of the power adapter for correct continuity and installation.
4. If the operational charge does not work, see “Check the Battery Pack” on page 85.

---

## Check the Battery Pack

To check the battery pack, do the following:

From Software:

1. Check out the Power Management in control Panel
2. In Power Meter, confirm that if the parameters shown in the screen for Current Power Source and Total Battery Power Remaining are correct.
3. Repeat the steps 1 and 2, for both battery and adapter.
4. This helps you identify first the problem is on recharging or discharging.

From Hardware:

1. Power off the computer.
2. Remove the battery pack and measure the voltage between battery terminals 1(+) and 6(ground). See the following figure

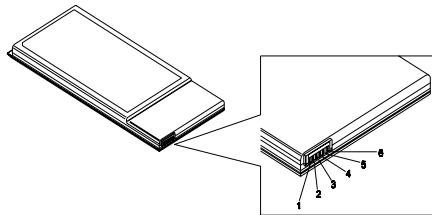

3. If the voltage is still less than 7.5 Vdc after recharging, replace the battery.

To check the battery charge operation, use a discharged battery pack or a battery pack that has less than 50% of the total power remaining when installed in the computer.

If the battery status indicator does not light up, remove the battery pack and let it return to room temperature. Re-install the battery pack.

If the charge indicator still does not light up, replace the battery pack. If the charge indicator still does not light up, replace the DC/DC charger board.

## Touchpad Check

If the touchpad doesn't work, do the following actions one at a time to correct the problem. Do not replace a non-defective FRU:

1. Reconnect the touchpad cables.
2. Replace the touchpad.
3. Replace the system board.

After you use the touchpad, the pointer drifts on the screen for a short time. This self-acting pointer movement can occur when a slight, steady pressure is applied to the touchpad pointer. This symptom is not a hardware problem. No service actions are necessary if the pointer movement stops in a short period of time.

---

# Power-On Self-Test (POST) Error Message

The POST error message index lists the error message and their possible causes. The most likely cause is listed first.

**NOTE:** Perform the FRU replacement or actions in the sequence shown in FRU/Action column, if the FRU replacement does not solve the problem, put the original part back in the computer. Do not replace a non-defective FRU.

This index can also help you determine the next possible FRU to be replaced when servicing a computer.

If the symptom is not listed, see “Undetermined Problems” on page 98.

The following lists the error messages that the BIOS displays on the screen and the error symptoms classified by function.

**NOTE:** Most of the error messages occur during POST. Some of them display information about a hardware device, e.g., the amount of memory installed. Others may indicate a problem with a device, such as the way it has been configured.

**NOTE:** If the system fails after you make changes in the BIOS Setup Utility menus, reset the computer, enter Setup and install Setup defaults or correct the error.

# Index of Error Messages

## Error Code List

Error Codes	Error Messages
006	Equipment Configuration Error Causes: 1. CPU BIOS Update Code Mismatch 2. IDE Primary Channel Master Drive Error (The causes will be shown before "Equipment Configuration Error")
010	Memory Error at xxxx:xxxx:xxxxh (R:xxxxh, W:xxxxh)
070	Real Time Clock Error
071	CMOS Battery Bad
072	CMOS Checksum Error
110	System disabled. Incorrect password is specified.
<No error code>	Battery critical LOW In this situation BIOS will issue 4 short beeps then shut down system, no message will show.
<No error code>	Thermal critical High In this situation BIOS will shut down system, not show message.

## Error Message List

Error Messages	FRU/Action in Sequence
Failure Fixed Disk	Reconnect hard disk drive connector. "Load Default Settings" in BIOS Setup Utility. Hard disk drive System board
Stuck Key	see "Keyboard or Auxiliary Input Device Check" on page 82.
Keyboard error	see "Keyboard or Auxiliary Input Device Check" on page 82.
Keyboard Controller Failed	see "Keyboard or Auxiliary Input Device Check" on page 82.
Keyboard locked - Unlock key switch	Unlock external keyboard
Monitor type does not match CMOS - Run Setup	Run "Load Default Settings" in BIOS Setup Utility.
Shadow RAM Failed at offset: nnnn	BIOS ROM System board
System RAM Failed at offset: nnnn	DIMM System board
Extended RAM Failed at offset: nnnn	DIMM System board
System battery is dead - Replace and run Setup	Replace RTC battery and Run BIOS Setup Utility to reconfigure system time, then reboot system.
System CMOS checksum bad - Default configuration used	RTC battery Run BIOS Setup Utility to reconfigure system time, then reboot system.
System timer error	RTC battery Run BIOS Setup Utility to reconfigure system time, then reboot system. System board

## Error Message List

Error Messages	FRU/Action in Sequence
Real time clock error	RTC battery Run BIOS Setup Utility to reconfigure system time, then reboot system. System board
Previous boot incomplete - Default configuration used	Run "Load Default Settings" in BIOS Setup Utility. RTC battery System board
Memory size found by POST differed from CMOS	Run "Load Default Settings" in BIOS Setup Utility. DIMM System board
Diskette drive A error	Check the drive is defined with the proper diskette type in BIOS Setup Utility See "External Diskette Drive Check" on page 82.
Incorrect Drive A type - run SETUP	Check the drive is defined with the proper diskette type in BIOS Setup Utility
System cache error - Cache disabled	System board
CPU ID:	System board
DMA Test Failed	DIMM System board
Software NMI Failed	DIMM System board
Fail-Safe Timer NMI Failed	DIMM System board
Device Address Conflict	Run "Load Default Settings" in BIOS Setup Utility. RTC battery System board
Allocation Error for device	Run "Load Default Settings" in BIOS Setup Utility. RTC battery System board
Failing Bits: nnnn	DIMM BIOS ROM System board
Fixed Disk n	None
Invalid System Configuration Data	BIOS ROM System board
I/O device IRQ conflict	Run "Load Default Settings" in BIOS Setup Utility. RTC battery System board
Operating system not found	Enter Setup and see if fixed disk and drive A: are properly identified. Diskette drive Hard disk drive System board



## Error Message List

No beep Error Messages	FRU/Action in Sequence
No beep, power-on indicator turns off and LCD is blank.	Power source (battery pack and power adapter). See "Power System Check" on page 83.. Ensure every connector is connected tightly and correctly. Reconnect the DIMM. LED board. System board.
No beep, power-on indicator turns on and LCD is blank.	Power source (battery pack and power adapter). See "Power System Check" on page 83.. Reconnect the LCD connector Hard disk drive LCD inverter ID LCD cable LCD Inverter LCD System board
No beep, power-on indicator turns on and LCD is blank. But you can see POST on an external CRT.	Reconnect the LCD connectors. LCD inverter ID LCD cable LCD inverter LCD System board
No beep, power-on indicator turns on and a blinking cursor shown on LCD during POST.	Ensure every connector is connected tightly and correctly. System board
No beep during POST but system runs correctly.	Speaker System board

# Phoenix BIOS Beep Codes

Code	Beeps	POST Routine Description
02h		Verify Real Mode
03h		Disable Non-Maskable Interrupt (NMI)
04h		Get CPU type
06h		Initialize system hardware
08h		Initialize chipset with initial POST values
09h		Set IN POST flag
0Ah		Initialize CPU registers
0Bh		Enable CPU cache
0Ch		Initialize caches to initial POST values
0Eh		Initialize I/O component
0Fh		Initialize the local bus IDE
10h		Initialize Power Management
11h		Load alternate registers with initial POST values
12h		Restore CPU control word during warm boot
13h		Initialize PCI Bus Mastering devices
14h		Initialize keyboard controller
16h	1-2-2-3	BIOS ROM checksum
17h		Initialize cache before memory autosize
18h		8254 timer initialization
1Ah		8237 DMA controller initialization
1Ch		Reset Programmable Interrupt Controller
20h	1-3-1-1	Test DRAM refresh
22h	1-3-1-3	Test 8742 Keyboard Controller
24h		Set ES segment register to 4 GB
26h		Enable A20 line
28h		Autosize DRAM
29h		Initialize POST Memory Manager
2Ah		Clear 215 KB base RAM
2Ch	1-3-4-1	RAM failure on address line xxxx
2Eh	1-3-4-3	RAM failure on data bits xxxx of low byte of memory bus
2Fh		Enable cache before system BIOS shadow
30h	1-4-1-1	RAM failure on data bits xxxx of high byte of memory bus
32h		Test CPU bus-clock frequency
33h		Initialize Phoenix Dispatch Manager
36h		Warm start shut down
38h		Shadow system BIOS ROM
3Ah		Autosize cache
3Ch		Advanced configuration of chipset registers
3Dh		Load alternate registers with CMOS values
42h		Initialize interrupt vectors
45h		POST device initialization

Code	Beeps	POST Routine Description
46h	2-1-2-3	Check ROM copyright notice
48h		Check video configuration against CMOS
49h		Initialize PCI bus and devices
4Ah		Initialize all video adapters in system
4Bh		QuietBoot start (optional)
4Ch		Shadow video BIOS ROM
4Eh		Display BIOS copyright notice
50h		Display CPU type and speed
51h		Initialize EISA board
52h		Test keyboard
54h		Set key click if enabled
58h	2-2-3-1	Test for unexpected interrupts
59h		Initialize POST display service
5Ah		Display prompt "Press F2 to enter SETUP"
5Bh		Disable CPU cache
5Ch		Test RAM between 512 and 640 KB
60h		Test extended memory
62h		Test extended memory address lines
64h		Jump to User Patch1
66h		Configure advanced cache registers
67h		Initialize Multi Processor APIC
68h		Enable external and CPU caches
69h		Setup System Management Mode (SMM) area
6Ah		Display external L2 cache size
6Bh		Load custom defaults (optional)
6Ch		Display shadow-area message
6Eh		Display possible high address for UMB recovery
70h		Display error messages
72h		Check for configuration errors
76h		Check for keyboard errors
7Ch		Set up hardware interrupt vectors
7Eh		Initialize coprocessor if present
80h		Disable onboard Super I/O ports and IRQs
81h		Late POST device initialization
82h		Detect and install external RS232 ports
83h		Configure non-MCD IDE controllers
84h		Detect and install external parallel ports
85h		Initialize PC-compatible PnP ISA devices
86h		Re-initialize onboard I/O ports
87h		Configure Motherboard Configurable Devices (optional)
88h		Initialize BIOS Area
89h		Enable Non-Maskable Interrupts (NMI)
8Ah		Initialize Extended BIOS Data Area
8Bh		Test and initialize PS/2 mouse

Code	Beeps	POST Routine Description
8Ch		Initialize floppy controller
8Fh		Determine number of ATA drives (optional)
90h		Initialize hard-disk controllers
91h		Initialize local-bus hard-disk controllers
92h		Jump to UserPatch2
93h		Build MPTABLE for multi-processor boards
95h		Install CD ROM for boot
96h		Clear huge ES segment register
97h		Fixup Multi Processor table
98h	1-2	Search for option ROMs. One long, two short beeps on checksum failure.
99h		Check for SMART drive (optional)
9Ah		Shadow option ROMs
9Ch		Set up Power Management
9Dh		Initialize security engine (optional)
9Eh		Enable hardware interrupts
9Fh		Determine number of ATA and SCSI drives
A0h		Set time of day
A2h		Check key lock
A4h		Initialize Typematic rate
A8h		Erase F2 prompt
AAh		Scan for F2 key stroke
ACh		Enter SETUP
AEh		Clear Boot flag
B0h		Check for errors
B2h		POST done- prepare to boot operating system
B4h	1	One short beep before boot
B5h		Terminate QuietBoot (optional)
B6h		Check password (optional)
B9h		Prepare Boot
BAh		Initialize DMI parameters
BBh		Initialize PnP Option ROMs
BCh		Clear parity checkers
BDh		Display MultiBoot menu
BEh		Clear screen (optional)
BFh		Check virus and backup reminders
C0h		Try to boot with INT 19
C1h		Initialize POST Error Manager (PEM)
C2h		Initialize error logging
C3h		Initialize error display function
C4h		Initialize system error handler
C5h		PnPnd dual CMOS (optional)
C6h		Initialize notebook docking (optional)
C7h		Initialize notebook docking late
C8h		Force check (optional)
C9h		Extended checksum (optional)

Code	Beeps	POST Routine Description
D2h		Unknown interrupt

Code	Beeps	POST Routine Description
E0h		Initialize the chipset
E1h		Initialize the bridge
E2h		Initialize the CPU
E3h		Initialize the system timer
E4h		Initialize system I/O
E5h		Check force recovery boot
E6h		Checksum BIOS ROM
E7h		Go to BIOS
E8h		Set Huge Segment
E9h		Initialize Multi Processor
EAh		Initialize OEM special code
EBh		Initialize PIC and DMA
ECh		Initialize Memory type
EDh		Initialize Memory size
EEh		Shadow Boot Block
EFh		System memory test
F0h		Initialize interrupt vectors
F1h		Initialize Run Time Clock
F2h		Initialize video
F3h		Initialize System Management Mode
F4h	1	Output one beep before boot
F5h		Boot to Mini DOS
F6h		Clear Huge Segment
F7h		Boot to Full DOS

# Index of Symptom-to-FRU Error Message

## LCD-Related Symptoms

Symptom / Error	Action in Sequence
LCD backlight doesn't work LCD is too dark LCD brightness cannot be adjusted LCD contrast cannot be adjusted	Enter BIOS Utility to execute "Load Setup Default Settings", then reboot system. Reconnect the LCD connectors. Keyboard (if contrast and brightness function key doesn't work). LCD inverter ID LCD cable LCD inverter LCD System board
Unreadable LCD screen Missing pels in characters Abnormal screen Wrong color displayed	Reconnect the LCD connector LCD inverter ID LCD cable LCD inverter LCD System board
LCD has extra horizontal or vertical lines displayed.	LCD inverter ID LCD inverter LCD cable LCD System board

## Indicator-Related Symptoms

Symptom / Error	Action in Sequence
Indicator incorrectly remains off or on, but system runs correctly	Reconnect the inverter board Inverter board System board

## Power-Related Symptoms

Symptom / Error	Action in Sequence
Power shuts down during operation	Power source (battery pack and power adapter). See "Power System Check" on page 83. Battery pack Power adapter Hard drive & battery connection board System board
The system doesn't power-on.	Power source (battery pack and power adapter). See "Power System Check" on page 83. Battery pack Power adapter Hard drive & battery connection board System board
The system doesn't power-off.	Power source (battery pack and power adapter). See "Power System Check" on page 83. Hold and press the power switch for more than 4 seconds. System board

## Power-Related Symptoms

Symptom / Error	Action in Sequence
Battery can't be charged	See "Check the Battery Pack" on page 85. Battery pack System board

## PCMCIA-Related Symptoms

Symptom / Error	Action in Sequence
System cannot detect the PC Card (PCMCIA)	PCMCIA slot assembly System board
PCMCIA slot pin is damaged.	PCMCIA slot assembly

## Memory-Related Symptoms

Symptom / Error	Action in Sequence
Memory count (size) appears different from actual size.	Enter BIOS Setup Utility to execute "Load Default Settings, then reboot system. DIMM System board

## Speaker-Related Symptoms

Symptom / Error	Action in Sequence
In Windows, multimedia programs, no sound comes from the computer.	Audio driver Speaker System board
Internal speakers make noise or emit no sound.	Speaker System board

## Power Management-Related Symptoms

Symptom / Error	Action in Sequence
The system will not enter hibernation	See "Save to Disk (S4)" on page 47. Keyboard (if control is from the keyboard) Hard disk drive System board
The system doesn't enter hibernation mode and four short beeps every minute.	Press Fn+  and see if the computer enters hibernation mode. Touchpad Keyboard Hard disk connection board Hard disk drive System board
The system doesn't enter standby mode after closing the LCD	See "Save to Disk (S4)" on page 47. LCD cover switch System board
The system doesn't resume from hibernation mode.	See "Save to Disk (S4)" on page 47. Hard disk connection board Hard disk drive System board
The system doesn't resume from standby mode after opening the LCD.	See "Save to Disk (S4)" on page 47. LCD cover switch System board

## Power Management-Related Symptoms

Symptom / Error	Action in Sequence
Battery fuel gauge in Windows doesn't go higher than 90%.	Remove battery pack and let it cool for 2 hours. Refresh battery (continue use battery until power off, then charge battery). Battery pack System board
System hangs intermittently.	Reconnect hard disk/CD-ROM drives. Hard disk connection board System board

## Peripheral-Related Symptoms

Symptom / Error	Action in Sequence
System configuration does not match the installed devices.	Enter BIOS Setup Utility to execute "Load Default Settings", then reboot system. Reconnect hard disk/CD-ROM/diskette drives.
External display does not work correctly.	Press Fn+F5, LCD/CRT/Both display switching System board
USB does not work correctly	System board
Print problems.	Ensure the "Parallel Port" in the "Onboard Devices Configuration" of BIOS Setup Utility is set to Enabled. Onboard Devices Configuration Run printer self-test. Printer driver Printer cable Printer System Board
Serial or parallel port device problems.	Ensure the "Serial Port" in the Devices Configuration" of BIOS Setup Utility is set to Enabled. Device driver Device cable Device System board

## Keyboard/Touchpad-Related Symptoms

Symptom / Error	Action in Sequence
Keyboard (one or more keys) does not work.	Reconnect the keyboard cable. Keyboard System board
Touchpad does not work.	Reconnect touchpad cable. Touchpad board System board

## Modem-Related Symptoms

Symptom / Error	Action in Sequence
Internal modem does not work correctly.	Modem phone port modem combo board System board

**NOTE:** If you cannot find a symptom or an error in this list and the problem remains, see "Undetermined Problems" on page 98.



---

# Intermittent Problems

Intermittent system hang problems can be caused by a variety of reasons that have nothing to do with a hardware defect, such as: cosmic radiation, electrostatic discharge, or software errors. FRU replacement should be considered only when a recurring problem exists.

When analyzing an intermittent problem, do the following:

1. Run the advanced diagnostic test for the system board in loop mode at least 10 times.
2. If no error is detected, do not replace any FRU.
3. If any error is detected, replace the FRU. Rerun the test to verify that there are no more errors.

---

# Undetermined Problems

The diagnostic problems does not identify which adapter or device failed, which installed devices are incorrect, whether a short circuit is suspected, or whether the system is inoperative.

Follow these procedures to isolate the failing FRU (do not isolate non-defective FRU).

**NOTE:** Verify that all attached devices are supported by the computer.

**NOTE:** Verify that the power supply being used at the time of the failure is operating correctly. (See "Power System Check" on page 83.):

1. Power-off the computer.
2. Visually check them for damage. If any problems are found, replace the FRU.
3. Remove or disconnect all of the following devices:
  - Non-Acer devices
  - Printer, mouse, and other external devices
  - Battery pack
  - Hard disk drive
  - DIMM
  - CD-ROM/Diskette drive Module
  - PC Cards
4. Power-on the computer.
5. Determine if the problem has changed.
6. If the problem does not recur, reconnect the removed devices one at a time until you find the failing FRU.
7. If the problem remains, replace the following FRU one at a time. Do not replace a non-defective FRU:
  - System board
  - LCD assembly

# Jumper and Connector Locations

## Top View

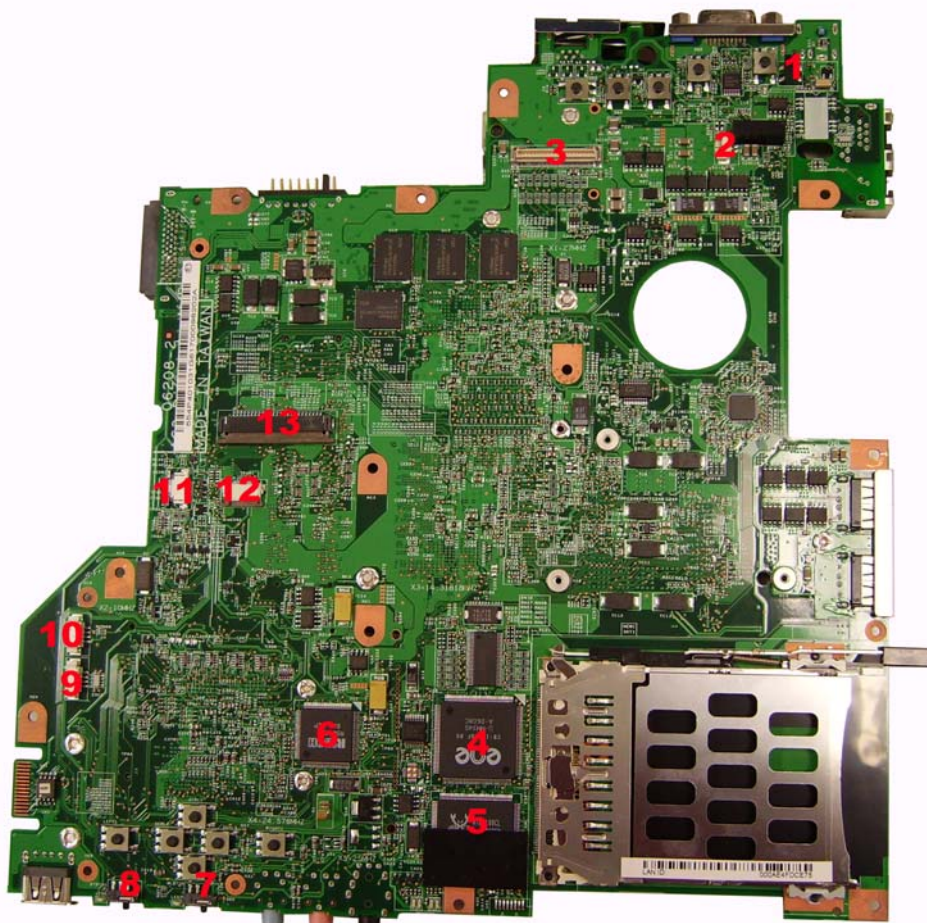

1	CVR1	LID switch	8	BTBTN1	Bluetooth launch switch
2	MIC1	Microphone cable connector	9	SPK1	Speaker set cable
3	LCD1	LCD cable connector	10	BT1	Bluetooth module cable connector
4	U38	Cardbus controller (ENE CB-1410)	11	LEDB1	LED FFC connector
5	U43	LAN controller (Realtek RTL8100CL)	12	TAPD1	Touchpad cable connector
6	N/A	Card reader controller (Ricoh R5C832)	13	KB1	Keyboard cable connector
7	WLBTN1	Wireless launch switch			

## Bottom View

**NOTE:** This is engineering sample. The image above may not be exactly the same as the real main board you get.

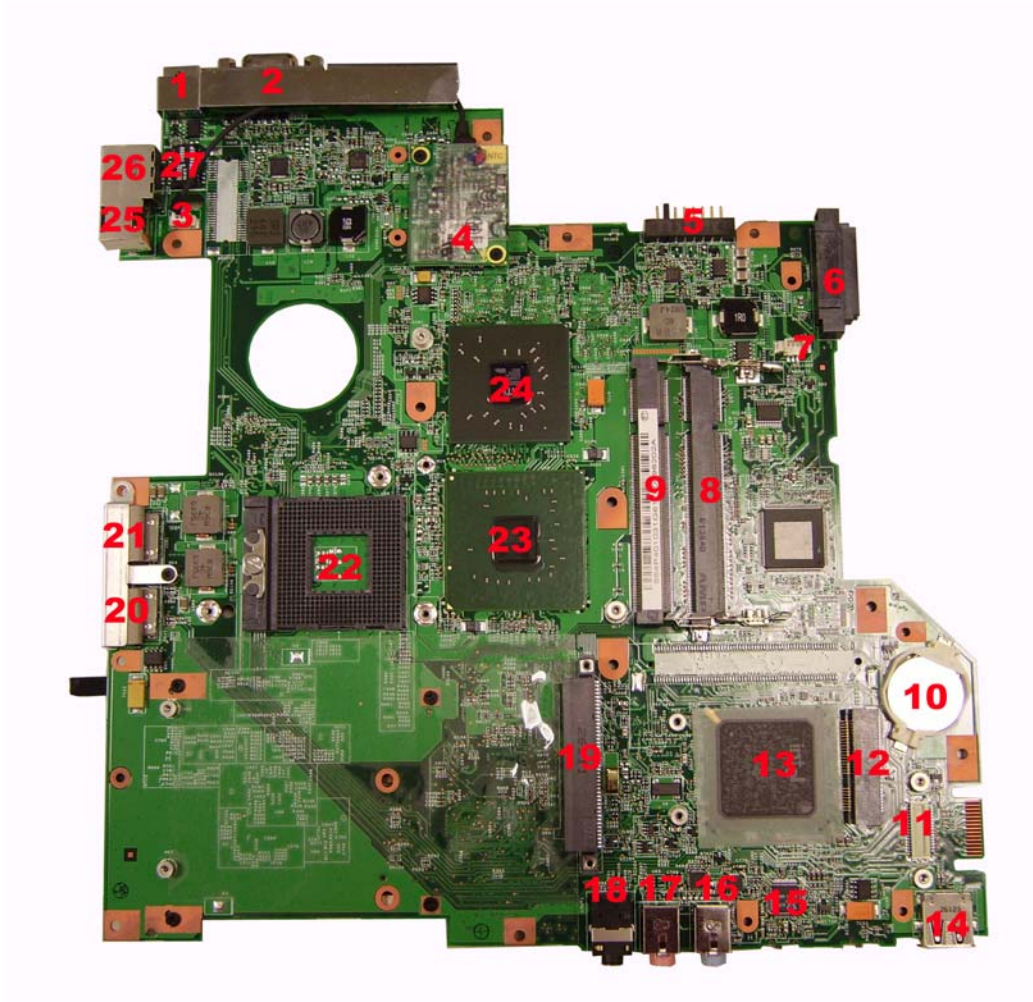

1	DCIN1	DC-in jack	14	USB3	USB port
2	CRT1	External display port	15	U67	Audio codec (Realtek ALC833)
3	N/A	Modem cable connector	16	LIN1	Line-in jack
4	MDC1	Modem board connector	17	MIC2	Microphone jack
5	BAT1	Battery connector	18	LOUT1	Headphone/speaker/line-out jack
6	CDROM1	ODD module connector	19	HDD1	HDD module connector
7	FAN1	System fan connector	20-21	USB1	USB ports
8	DM2	DIMM 2 socket	22	U58	CPU socket
9	DM1	DIMM 1 socket	23	U56	North Bridge
10	RTC1	RTC battery	24	U53	VGA controller
11	CN2	Card reader board connector	25	TRING1	Modem jack
12	MINIC1	Wireless LAN card slot	26	RJ1	LAN jack
13	U62	South bridge (Intel ICH7M)			

## Jumper Settings/Clear BIOS Password Procedures

1. Remove the DIMM cover and the lower DDR2 memory module, then find out the G96 position on the main board. Please just the lower DDR2 memory module, you will need the upper DDR2 memory module to boot up the system. (You should tear off the mylar to see G96).

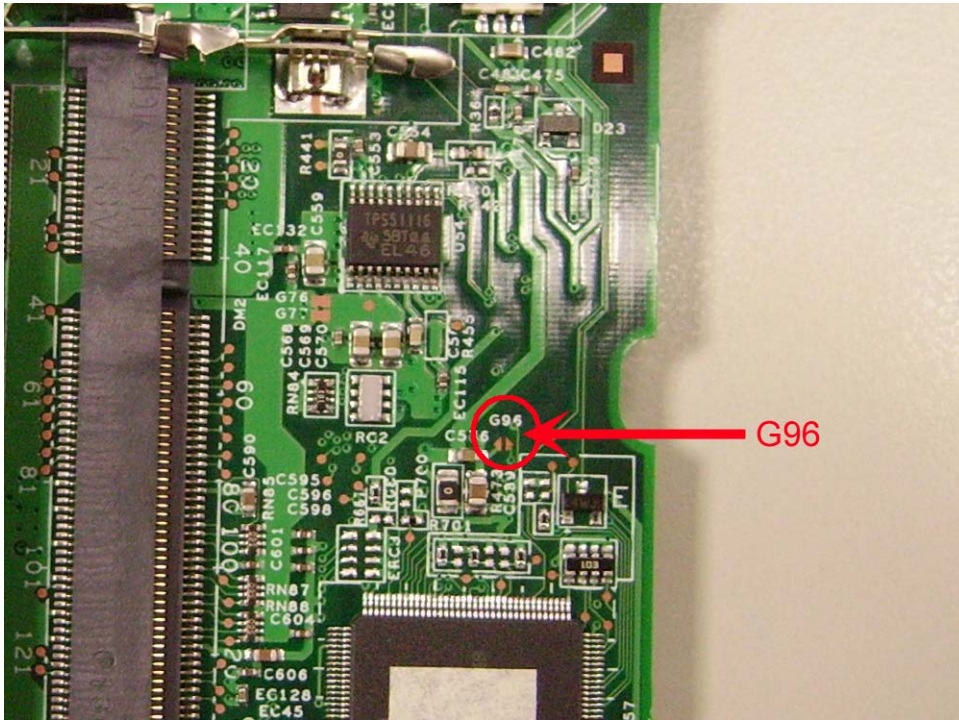

2. Use a tweezers or a screwdriver to short the G96 pad and remain the short status.

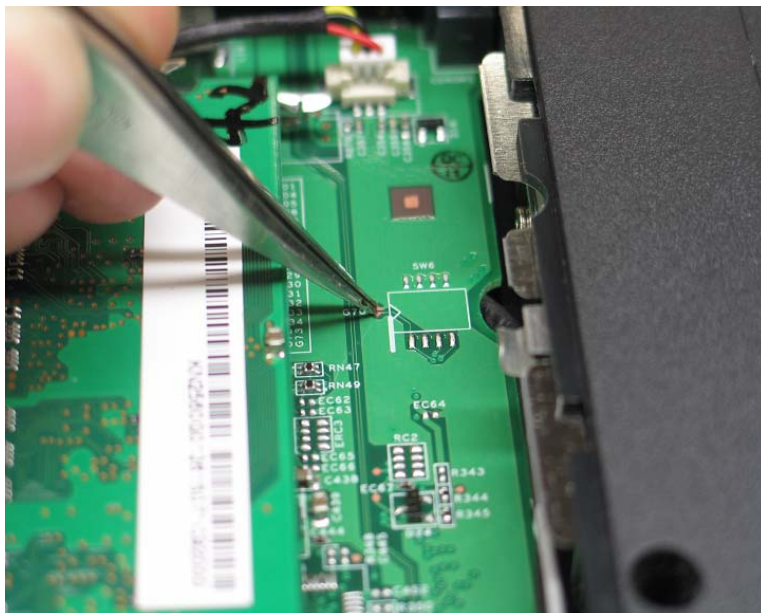

3. Power on the system until POST is completed. Then you can release the tweezers or screwdriver. The BIOS password should be cleared after these steps.



## FRU (Field Replaceable Unit) List

---

This chapter gives you the FRU (Field Replaceable Unit) listing in global configurations of Aspire 3640/TravelMate 2440. Refer to this chapter whenever ordering for parts to repair or for RMA (Return Merchandise Authorization).

Please note that WHEN ORDERING FRU PARTS, you should check the most up-to-date information available on your regional web or channel. For whatever reasons a part number change is made, it will not be noted on the printed Service Guide. For ACER AUTHORIZED SERVICE PROVIDERS, your Acer office may have a DIFFERENT part number code from those given in the FRU list of this printed Service Guide. You MUST use the local FRU list provided by your regional Acer office to order FRU parts for repair and service of customer machines.





**NOTE:** To scrap or to return the defective parts, you should follow the local government ordinance or regulations on how to dispose it properly, or follow the rules set by your regional Acer office on how to return it.

# Aspire 3640/TravelMate 2440 Exploded Diagram

## Aspire 3640/TravelMate 2440 FRU List

Category	No.	Part Name and Description	Acer Part No.
Adapter			
		ADAPTER 65W DELTA SADP-65KB DBE	AP.06501.007
		ADAPTER 65W LITEON PA-1650-02WR	AP.06503.011
		ADAPTER 65W LISHIN SLS0335A19A54LF	AP.06506.003
Battery			
		BATTERY PACK LI 6CELL 2.0MAH SANYO	BT.00603.014
		BATTERY PACK LI+ 6CELL 2.0MAH SONY	BT.00604.006
		BATTERY PACK LI 6CELL 2.0MAH PANASONIC	BT.00605.002
		BATTERY PACK LI+ 6CELL 2.4MAH SANYO	BT.00603.012
		BATTERY PACK LI+ 6CELL 2.4MAH SONY	BT.00604.005
		BATTERY PACK LI+ 6CELL 2.4MAH PANASONIC	BT.00605.003
		BATTERY PACK LI+ 9CELL 2.4MAH SANYO	BT.00903.004
Boards			
		WIRELESS LAN BOARD 802.11BG FOXCONN ATHEROS EU	54.A74V1.001
		WIRELESS LAN BOARD 802.11BG FOXCONN BCM4318	54.A74V1.002
		MODEM BOARD FOXCONN T60M845.01	54.TCZV1.001
		TOUCHPAD BOARD SYNAPTICS TM51-389	56.TB1V1.001
		LED BOARD	55.TCZV1.001



Category	No.	Part Name and Description	Acer Part No.
		BLUETOOTH MODULE FOXCONN BCM2045 <b>Note: The bluetooth module does not contain the black mylar as the image shows..</b>	54.TB2V1.001
		BT MODULE FOXCONN BCM2045 V00	54.A74V1.003
Cables			
		MODEM CABLE	50.TCZV1.006
		LED CABLE	50.TCZV1.001
		TOUCHPAD CABLE	50.TCZV1.002
		BLUETOOTH CABLE	50.TCZV1.003
		POWER CORD 2.5A 125V USA	27.01518.781
		POWER CORD 10A 250V 3PIN CHINA	27.01518.591
		POWER CORD 10A 125V US	27.T30V1.001
		POWER CORD 7A 250V 2PIN KOREAN	27.01518.531
		POWER CORD 3A 250V 3PIN UK	27.01518.541
		POWER CORD 220V 3PIN EUR	27.T30V1.004
		POWER CORD 7A 125V 2PIN JAPEN	27.01518.551
		POWER CORD 10A 3PIN BK	27.01518.561
		POWER CORD 10A 250V 3PIN ITALY	27.01518.611
		POWER CORD 10A 250V 3PIN BK SOUTH AFRICA	27.01518.571
		POWER CORD 10A 250V SWISS	27.01518.581
		POWER CORD 2.5A 250V AUSTRALIA	27.01518.621
		POWER CORD 2.5A 250V SOUTH AFRICA BK	27.01518.631
		POWER CODE 7A 125V JAPAN 2PIN	27.03518.161
Case/Cover/Bracket/Assembly			

Category	No.	Part Name and Description	Acer Part No.
		LOWERCASE W/SPEAKER	60.TCZV1.001
Speaker			
		SPEAKER	23.TCZV1.003
Case/Cover/Bracket/Assembly			
		MIDDLE COVER W/MICROPHONE (TRAVELMATE)	60.TCZV1.003
		MIDDLE COVER W/MICROPHONE (ASPIRE)	60.ADKV1.003
		FRONT COVER	42.TCZV1.003
		DIMM COVER	42.TCZV1.002
		HDD COVER	42.TCZV1.001
		TOUCHPAD BRACKET	33.TCZV1.001
		UPPER CASE (TRAVELMATE)	60.TCZV1.002
		UPPER CASE (ASPIRE)	60.ADKV1.002
Combo Module			







Category	No.	Part Name and Description	Acer Part No.
		COMBO MODULE 24X	6M.TB2V1.001
		OPTICAL FIX HOLDER BRACKET	33.TB2V1.002
		OPTICAL RAIL HOLDER	33.TB2V1.003
		OPTICAL BEZEL GBASE FOR COMBO	42.TB2V1.003
		COMBO MODULE 24X HLDS GCC-4244N LF 1.00AB W/O BEZEL	KO.0240A.005
		COMBO MODULE 24X LITEON SOSC-2485K W/O BEZEL	KO.02409.015
CPU/Processor			
		CPU CEL-M370 1.5GMHZ INTEL	KC.NV001.370
		CPU DOTHAN730 1.6GMHZ INTEL	KC.N0001.730
		CPU DOTHAN740 1.73GMHZ INTEL	KC.N0001.740
		CPU DOTHAN725A 1.6GMHZ INTEL	KC.NA001.725
		CPU CEL-M370 1.5G MHZ INTEL	KC.NC001.370
		CPU CEL-M380 1.6GMHZ INTEL	KC.NV001.380
		CPU CEL-M390 1.7GMHZ INTEL	KC.NV001.390
		CPU CEL-M360 1.4GMHZ INTEL	KC.NV001.360
DVD Module			
		DVD-RW MODULE 8X	6M.TB2V1.002

Category	No.	Part Name and Description	Acer Part No.
		OPTICAL FIX HOLDER BRACKET	33.TB2V1.002
		OPTICAL RAIL HOLDER	33.TB2V1.003
		OPTICAL BEZEL GBASE FOR DUAL	42.TB2V1.003 42.TB2V1.004 (TM)
		DVD-RW DRIVE 8X S-MUTI HLDS GSA-4082N W/O BEZEL	KU.0080D.017
		DVD-RW DRIVE 8X DUAL LITEON SOSW-833S W/O BEZEL	KU.00804.012
		DUAL PIO/DVR-K16RA AG1 NOBZ LF	KU.00805.019
		DUAL PAN/UJ-850 AG1 NOBZL LF	KU.00807.022
		DUAL HLD/GWA-4082N MORAR GCP03	KU.0080D.019
		S-MUTI PAN/UJ-850 AG1 NOBZL LF	KU.00807.025
Fan			
		FAN SUNON AG1	23.TB2V1.003
HDD/Hard Disk Drive			
		HDD MODULE 40G	TBD
		ASSY HDD BRACKET AG1	33.TB2V1.004
		HDD 40GB SEAGATE ST9402112A	KH.04001.014
		HDD 40GB TOSHIBA MK4025GAS	KH.04004.005
		HDD 40GB HGST HTS421240H9AT00	KH.04007.013
		HDD 40GB WD WD400UE-22HCT0	KH.04008.025
		HDD 40GB SAMSUNG M40MP0402H	KH.0400B.003
		HDD MODULE 60G	TBD
		ASSY HDD BRACKET AG1	33.TB2V1.004



Category	No.	Part Name and Description	Acer Part No.
		HDD 60GB SEAGATE ST96812A	KH.06001.004
		HDD 60GB SEAGATE ST960812A	KH.06001.003
		HDD 60GB TOSHIBA MK6025GAS	KH.06004.004
		HDD 60G TOSHIBA	KH.06004.007
		HDD 60GB HGST HTS541260H9AT00	KH.06007.010
		HDD 60GB WD WD600UE-22HCT0	KH.06008.002
		HDD MODULE 80G	TBD
		HDD BRACKET	33.TB2V1.004
		HDD 80G TOSHIBA MK8025GAS	KH.08004.003
		HDD 80G HITACHI HTS421280H9AT00	KH.08007.011
		HDD 80G SEAGATE ST980829A	KH.08001.013
		HDD 80G SEAGATE ST98823A	KH.08001.014
		HDD 80G TOSHIBA MK8026GAX	KH.08004.004
		HDD 80G HGST HTS541280H9AT00	KH.08007.012
		HDD 80G WD WD800UE-22HCT0	KH.08008.027
		HDD MODULE 100G	TBD
		HDD BRACKET	33.TB2V1.004
		HDD 100GB SEAGATE ST9100825A	KH.10001.003
		HDD 100G TOSHIBA MK1031GAS	KH.10004.001
		HDD 100G HITACHI HTS421210H9AT00	KH.10007.002
		HDD 100G SEAGATE ST9100824A	KH.10001.004
		HDD 100G SATA SAMSUNG HM100JI	KH.1000B.001
		HDD MODULE 120G	TBD
		HDD BRACKET	33.TB2V1.004
		HDD 120G SEAGATE ST9120824A	KH.12001.014
		HDD 120G SEAGATE ST9120821A	KH.12001.015
<b>Heatsink</b>			
		CPU HEATSINK W/SCREW W/O FAN	34.TB2V1.001
<b>Keyboard</b>			
		KEYBOARD 89KEY DARFON NSK- H3M00 SWISS	KB.A2707.011
		KEYBOARD 88KEY DARFON NSK- H30M02 TAIWAN(CHINESE)	KB.A2707.002
		KEYBOARD 88KEY DARFON NSK- H3M03 THAI	KB.A2707.004



Category	No.	Part Name and Description	Acer Part No.
		KEYBOARD 89KEY DARFON NSK-H3M06 PORTUGA	KB.A2707.012
		KEYBOARD 88KEY DARFON NSK-H3M0A ARABIA	KB.A2707.013
		KEYBOARD 89KEY DARFON NSK-H3M0C CZECH	KB.A2707.016
		KEYBOARD 89KEY DARFON NSK-H3M0D DANISH	KB.A2707.019
		KEYBOARD 89KEY NSK-H3M0E DARFON ITALY	KB.A2707.009
		KEYBOARD 89KEY DARFON NSK-H3M0F FRENCH	KB.A2707.010
		KEYBOARD 89KEY DARFON NSK-H3M0G GERMAN	KB.A2707.008
		KEYBOARD 88KEY DARFON NSK-H3M0H HB	KB.A2707.024
		KEYBOARD 88KEY DARFON NSK-H3M0L GK	KB.A2707.023
		KEYBOARD 89KEY DARFON NSK-H3M0M CF	KB.A2707.021
		KEYBOARD 89KEY DARFON NSK-H3M0N NORWEGIAN	KB.A2707.018
		KEYBOARD 89KEY DARFON NSK-H3M0Q HG	KB.A2707.017
		KEYBOARD 88KEY DARFON NSK-H3M0R RUSSIAN	KB.A2707.025
		KEYBOARD 89KEY DARFON NSK-H3M0S SP	KB.A2707.003
		KEYBOARD 89KEY DARFON NSK-H3M0T TURKISH	KB.A2707.020
		KEYBOARD 89KEY DARFON NSK-H3M0U UK	KB.A2707.007
		KEYBOARD 89KEY DARFON NSK-H3M0W SWEDEN	KB.A2707.015
		KEYBOARD 89KEY DARFON NSK-H3M1A BELGIUM	KB.A2707.014
		KEYBOARD 89KEY DARFON NSK-H3M1B BR	KB.A2707.005
		KEYBOARD 88KEY DARFON NSK-H3M1D US-INTERNATIONAL	KB.A2707.001
<b>Keyboard (TM)</b>			
		KEYBOARD 89KEY DARFON NSK-AEK00 SWISS	KB.T5007.011
		KEYBOARD 88KEY DARFON NSK-AEK02 TAIWAN(CHINESE)	KB.T5007.002
		KEYBOARD 88KEY DARFON NSK-AEK03 THAI	KB.T5007.004
		KEYBOARD 89KEY DARFON NSK-AEK06 PORTUGA	KB.T5007.012
		KEYBOARD 88KEY DARFON NSK-AEK0A ARABIC	KB.T5007.013
		KEYBOARD 89KEY DARFON NSK-AEK0C CZECH	KB.T5007.016

Category	No.	Part Name and Description	Acer Part No.
		KEYBOARD 89KEY DARFON NSK-AEK0D DANISH	KB.T5007.019
		KEYBOARD 89KEY DARFON NSK-AEK0E ITALY	KB.T5007.009
		KEYBOARD 89KEY DARFON NSK-AEK0F FRENCH	KB.T5007.010
		KEYBOARD 88KEY DARFON NSK-AEK0G GERMAN	KB.T5007.008
		KEYBOARD 88KEY DARFON NSK-AEK0H HB	KB.T5007.024
		KEYBOARD 88KEY DARFON NSK-AEK0L GK	KB.T5007.023
		KEYBOARD 89KEY DARFON NSK-AEK0M CF	KB.T5007.021
		KEYBOARD 89KEY DARFON NSK-AEK0N NORWEGIAN	KB.T5007.018
		KEYBOARD 89KEY DARFON NSK-AEK0Q HG	KB.T5007.017
		KEYBOARD 88KEY DARFON NSK-AEK0R RUSSIAN	KB.T5007.025
		KEYBOARD 89KEY DARFON NSK-AEK0S SP	KB.T5007.003
		KEYBOARD 89KEY DARFON NSK-AEK0T TURKISH	KB.T5007.020
		KEYBOARD 89KEY DARFON NSK-AEK0U UK	KB.T5007.007
		KEYBOARD 89KEY DARFON NSK-AEK0W SWEDEN	KB.T5007.015
		KEYBOARD 89KEY DARFON NSK-AEK1A BELGIUM	KB.T5007.014
		KEYBOARD 89KEY DARFON NSK-AEK1B BR	KB.T5007.005
		KEYBOARD DARFON NSK-N7082 US-INTERNATIONAL	KB.T5007.001
		KEYBOARD 89KEY DARFON NSK-AEK1F SV	KB.T5007.026
<b>LCD Module</b>			
		LCD MODULE CCD 14.1" WXGA GLARE W/ANTENNA	6M.ADKV1.021(Aspire)
		LCD MODULE 14.1" WXGA NONE GLARE W/ANTENNA	6M.ADKV1.011(Aspire) 6M.TCZV1.011(TravelMate) 6M.TCZV1.012(TravelMate)
		INVERTER BOARD DARFON VK.21189.402	19.TCBV1.001
		INVERTER BOARD 15.4" FOXCONN T62I240.00	19.A46V1.003
		INVERTER BOARD 15.4" YEC YNV-W02	19.TB2V1.001

Category	No.	Part Name and Description	Acer Part No.
		WIRELESS ANTENNA LEFT/RIGHT	25.TCZV1.001
		LCD/INVERTER CABLE 14.1" WXGA	50.TCZV1.004
		LCD BRACKET RIGHT Note: Right bracket is the upper one.	33.TB1V1.003
		LCD BRACKET LEFT Note: Left bracket is the lower one	33.TB1V1.004
		LCD PANEL 14.1" W/HINGE	60.AA6V1.004(Aspire) 60.TB2V1.004(TravelMate) 60.TCZV1.005(TravelMate)
		LCD BEZEL 14.1" W/LOGO	60.TB2V1.005
		HINGE PACK LEFT/RIGHT	6K.TB2V1.001
		LCD 14.1" WXGA AU B141EW01 V.1 NONE GLARE	LK.14105.013
		LCD 14" WXGA SAMSUNG LTN141W1-L01 NONE GLARE	LK.14106.004
		LCD 14.1" WXGA LG LP141WX1- TL02 NONE GLARE	LK.14108.002
		LCD 14.1" WXGA QDI QD14TL01-03 NONE GLARE 420G	LK.14109.004
		LCD 14" WXGA CMO N141I1-L02 NONE GLARE	LK.1410D.004
		LCD MODULE 14.1" WXGA GLARE W/ANTENNA	6M.TB2V1.012
		INVERTER BOARD 15.4" FOXCONN T62I240.00	19.A46V1.003
		WIRELESS ANTENNA LEFT/RIGHT	25.TB2V1.001
		LCD/INVERTER CABLE 14.1" WXGA	50.TB2V1.007



Category	No.	Part Name and Description	Acer Part No.
		LCD BRACKET RIGHT	33.TB1V1.003
		LCD BRACKET LEFT	33.TB1V1.004
		LCD PANEL 14.1" W/HINGE	60.TB2V1.004
		LCD BEZEL 14.1" W/LOGO	60.TB2V1.005
		HINGE PACK LEFT/RIGHT	6K.TB2V1.001
		LCD 14.1" WXGA CMO N14111-L03 GLARE	LK.1410D.005
		LCD 14.1" WXGA QDI QD14TL01-02 GLARE 420G	LK.14109.005
		LCD 14.1" WXGA AU B141EW01 V.0 GLARE TYPE	LK.14105.014
		LCD 14.1" WXGA SAMSUNG LTN141W1-L01 GLARE	LK.14106.005
		LCD 14.1" WXGA LG LP141WX1- TL03 GLARE	LK.14108.003
<b>Mainboard</b>			
		MAINBOARD AG1910 W/O CPU W/ PCMCIA SLOT & RTC BATTERY	MB.TCZV1.001
<b>Battery</b>			
		RTC BATTERY	23.TCZV1.004
<b>PCMCIA Slot/PC Card Slot</b>			
		PCMCIA SLOY	22.TB2V1.001
<b>Memory</b>			
		SDIMM 256M INFINEON HYS64T32000HDL-3.7-A	KN.25602.023
		DIMM 256M NANYA NT256T64UH4A1FN-37B	KN.25603.029
		SDIMM 256M MICRON MT4HTF3264HY-53EB3	KN.25604.027
		SDIMM 256M SAMSUNG M470T3354CZ3-CD5	KN.2560B.017
		SDIMM 256M HYNIX HYMP532S64P6-C4	KN.2560G.006
		SDIMM 512M INFINEON MHYS64T64020HDL-3.7-A	KN.51202.021
		SDIMM 512M NANYA NT512T64UH8A1FN-37B	KN.51203.023
		SDIMM 512M MICRON MT8HTF6464HDY-53EB3	KN.51204.019
		SDIMM 512M SAMSUNG M470T6554CZ3-CD5	KN.5120B.015
		SDIMM 512M HYNIX HYMP564S64P6-C4	KN.5120G.005
<b>Miscellaneous</b>			

Category	No.	Part Name and Description	Acer Part No.
		LCD SCREW RUBBER LCD RUBBER CUSHION	47.A46V1.002
		LCD SCREW RUBBER	47.TB1V1.001
		NAME PLATE	40.ADKV1.001
		NAME PLIATE (TM)	40.TCZV1.001
Screws			
		SCW HEX NYL I#R-40/O#4-40 L5.5	34.00015.081
		SCREW MACH WAFER M2*L4 NI	86.00059.220
		SCRW M2*L3 BLACK	86.00C31.220
		SCRW M2 X 2	86.00C34.620
		SCR M2.5*12L B-ZN NYLOK I-HEAD	86.5A353.120
		SCREW M2.5-6	86.9A323.6R0
		WCH MSN+CBZ SCREW M2X2.5	86.9A352.2R5
		SCREW M2*3 NYLON 1JMCPC-420325	86.9A352.3R0
		SCREW	86.9A352.4R0
		SCREW M2.5*4L(NYLOCK)BLACK ZN	86.9A353.4R0
		SRW M2.5*8L B/ZN NYLOK 700	86.9A353.8R0
		SCREW M3x4(86.9A524.4R0)	86.9A524.4R0
		SCREW WAFER NYLOK NI 2ML3	86.9A552.3R0
		SCRW M2*4 WAFER NI	86.9A552.4R0
		SCRW M2.5*3 WAFER NI	86.9A553.3R0
		SCREW NYLOK M2.5-5	86.9A553.5R0
		SCREW M2.5*L3	86.00E08.223
Microphone			
		MICROPHONE	23.TCZV1.002



