



**Service and Support
Guide**

HP DeskJet 1220C
Professional Series



© Copyright
Hewlett-Packard Company
2000
All Rights Reserved.
Reproduction, adaptation,
or translation without prior
written permission is
prohibited, except as
allowed under the
copyright laws.

First edition, April 2000
Trademark Credits
Adobe and PostScript are
trademarks of Adobe
Systems Incorporated
which may be registered in
certain jurisdictions.
Windows is a U.S.
registered trademark of
Microsoft Corporation.

Warranty
The information contained
in this document is subject
to change without notice.
Hewlett-Packard makes no
warranty of any kind with
regard to this material,
including, but not limited
to, the implied warranties
or merchantability and
fitness for a particular
purpose.
Hewlett-Packard shall not
be liable for errors
contained herein or for
incidental or consequential
damages in connection
with the furnishing,
performance, or use of this
material.

WARNING
Electrical Shock Hazard
To avoid electrical shock,
use only supplied power
cords and connect only to
properly grounded wall
outlets.

Table of Contents

List of Tables	vii
List of Figures	ix
List of Trees	xi
Preface	xiii
Conventions.....	xiv
Chapter Descriptions	xv
Product Information	1-1
Product Overview	1-2
Product Positioning	1-2
Model and Serial Number	1-2
Technology Update	1-2
Printer Description and Features	1-4
External View	1-9
Specifications.....	1-11
Hewlett-Packard Print Cartridge Specifications	1-11
Printable Area	1-11
Safety and Regulatory Notices.....	1-12
Print Cartridge Safety	1-12
Material Safety Data Sheet (MSDS).....	1-13
LED Safety	1-13
FCC Regulations	1-13
Power Cord Statement	1-14
Declaration of Conformity	1-15
Energy Consumption	1-16
Service and Support Information.....	1-17
Parts and Supplies	1-17
Media Products	1-19
HP Web Support.....	1-21
HP Telephone Support.....	1-21
HP ASAP	1-24
HP Express Exchange	1-24
Warranty	1-26

Hewlett-Packard Limited Warranty	1-26
Extent of Limited Warranty	1-26
Limitations of Warranty	1-27
Limitations of Liability	1-27
Local Law	1-28
<i>Installing and Configuring the Printer</i>	<i>2-1</i>
Connecting Power to the Printer	2-2
Printing a Sample Page	2-2
Connecting the Interface Cable.....	2-3
Connecting via a USB Cable.....	2-3
Connecting via a Parallel Interface Cable.....	2-5
Installing Printer Software.....	2-6
Installing from the Starter CD (Recommended)	2-6
Verifying Communication in Windows	2-8
Printing a Self-Test Page.....	2-8
Checking the Interface Cable Connection.....	2-9
Using the Printer on a Network.....	2-10
Connecting to an External Print Server.....	2-10
Printer Sharing in Windows	2-11
Uninstalling Printer Software	2-13
For Windows 95/98/NT 4.0 Users	2-13
For Macintosh Users	2-13
<i>Printer Operation.....</i>	<i>3-1</i>
Using the Keypanel	3-2
Printer Buttons and LEDs	3-2
Using the Control Panel	3-4
Changing Default Print Settings	3-4
Restoring Factory Defaults	3-4
Using the HP DeskJet Control Panel for DOS.....	3-6
Installing the HP DeskJet Control Panel for DOS	3-6
Changing Print Settings in the HP DeskJet Control Panel	3-6
Using the HP 1220C ToolBox.....	3-7
<i>Paper Selection and Paper Loading</i>	<i>4-1</i>
Selecting Paper	4-2
Standard Paper.....	4-2
Custom Paper	4-2
Envelopes	4-2
Cards	4-3
Thick Cards	4-3
Labels	4-3
Transparencies and Slides.....	4-3

HP Special Paper	4-3
Loading Paper in Main (Bottom) Media Tray	4-4
Loading Paper in Alternative (Top) Media Feed	4-5
Loading Paper Through Rear Media Feed.....	4-6
Clearing Paper Jams.....	4-7
Tips for Avoiding Paper Jams	4-7
Printer Maintenance.....	5-1
Cleaning the Printer.....	5-2
Using and Caring for Print Cartridges.....	5-3
Print Cartridge Icons.....	5-3
Cleaning the Print Cartridges	5-4
Pen Recovery Diagnostic Test	5-4
Cleaning the Electrical Contacts.....	5-6
Tips for Maintaining the Print Cartridges	5-6
Print Cartridge Life.....	5-7
Changing the Print Cartridges	5-7
Aligning the Print Cartridges.....	5-9
Calibration Diagnostic Test	5-9
Troubleshooting	6-1
Troubleshooting Strategy	6-2
Software Troubleshooting.....	6-3
Problems with a Network Printer.....	6-4
Printer is not Responding	6-6
Printer Lights Blink.....	6-9
Paper Feed Problems	6-10
Paper Skew	6-13
A Blank Page is Printed.....	6-14
Poor Print Quality	6-16
Unexpected Results	6-21
Hardware Troubleshooting	6-27
Troubleshooting Tools	6-27
Diagnostic Tools.....	6-27
The HP DeskJet 1220C Quick Checkup.....	6-28
Troubleshooting Hardware Problems	6-29
Troubleshooting Power On Problems	6-30
Troubleshooting Printer Initialization Problems	6-33
Troubleshooting Using LEDs.....	6-36
Troubleshooting Paper Feed Problems.....	6-47
Troubleshooting the Self-Test.....	6-49
Troubleshooting Paper Eject Problems	6-55
Troubleshooting Unusual Noises	6-57
Diagnostic Tools.....	6-59
Self-Test.....	6-59

Sample Page	6-60
Single Diagnostic Test	6-61
Nozzle Pattern Diagnostic Test	6-62
Pen Recovery Diagnostic Test	6-63
Calibration Diagnostic Test	6-64
Extended Diagnostic Test	6-66
Dot Count Diagnostic Test	6-67
Pen ID Diagnostic Test	6-68
Infinite Hs Diagnostic Test	6-69
Page Alignment Diagnostic Test	6-70
DeskJet 1220C Software Diagnostic Test Program	6-72

Removal, Replacement, and Calibration..... 7-1

Removal and Replacement Strategy	7-3
Removal and Replacement Tools.....	7-3
Before You Begin	7-3
Tips for Disassembling the Printer	7-4
Disassembly Sequence	7-5
Consumer Removable Parts.....	7-6
Output Tray	7-6
Stopper Assembly.....	7-6
Cleanout Trough Assembly	7-7
Parts Serviceable without Calibration	7-8
Stopper Guides.....	7-8
Rubber Feet	7-9
Access Door Assembly	7-9
Logic PCA Assembly	7-10
Left End Cap Assembly	7-11
Power Supply Assembly	7-12
Power Insulator	7-13
Right End Cap Assembly.....	7-13
Keypanel PCA	7-14
Main Logic Harness Assembly	7-14
Power Switch Harness	7-15
Hand Grabs.....	7-15
Linefeed/Encoder PCA	7-15
Encoder Disk Assembly	7-16
Output Belt	7-16
Encoder Strip	7-17
Carriage Motor Assembly.....	7-18
Service Station Mechanism Assembly	7-19
Spot Sensor Assembly	7-19
Pivot Spring and Rocker Plate Spring.....	7-20
Rail Cover	7-21
Starwheels Assembly	7-21
Output Mechanism Assembly	7-22

Output Motor Assembly	7-23
Input Tray Assembly	7-23
Pick Roller Assembly	7-25
Serviceable Parts that Require Calibration	7-27
Carriage Assembly/Carriage Rod	7-27
Flex Cable.....	7-28
Backbone Assembly	7-29
Upper Paper Guide Assembly	7-29
Drive Roller Assembly	7-31
Trough-1 Assembly.....	7-32
Right Support Assembly	7-33
Left Support Assembly	7-34
Base Plate Assembly	7-34
Removal of Subassembly Parts.....	7-35
Calibrating the Printer.....	7-37
Calibration Tool	7-37
How to Calibrate	7-37
Parts and Diagrams	8-1
Exploded View	8-2
Exploded View Parts List	8-3
Subassembly Exploded Views	8-7
Subassembly Exploded Views Parts List	8-11
Alphabetical Parts List.....	8-13
Numerical Parts List	8-17
Low Usage Kits	8-21
Appendix	A-1

List of Tables

Table 1.1	Printer Description and Features	1-4
Table 1.2	Hewlett-Packard Print Cartridge Specifications	1-11
Table 1.3	Printer Parts	1-17
Table 1.4	Media Products	1-19
Table 1.5	Ordering Parts	1-20
Table 1.6	Ordering Supplies	1-21
Table 1.7	HP Telephone Support	1-21
Table 1.8	Customer Support in the US	1-23
Table 1.9	Customer Support outside the US	1-23
Table 1.10	HP AUDIO-TIPS in Europe	1-24
Table 1.11	Hewlett-Packard Limited Warranty	1-26
Table 3.1	Printer Lights During Normal Printing	3-3
Table 3.2	HP 1220C ToolBox Features	3-7
Table 5.1	Print Cartridge Icons	5-3
Table 6.1	Software Troubleshooting	6-3
Table 6.2	Printer Lights Blink	6-9
Table 6.3	Poor Print Quality	6-16
Table 6.4	Unexpected Results	6-21
Table 6.5	Printer Lights During Normal Printing	6-37
Table 6.6	Basic Error Light Patterns	6-37
Table 6.7	Advanced Error Light Patterns	6-39
Table 6.8	Interpreting the Blink Code	6-41
Table 6.9	Error Trapped Codes	6-43
Table 6.10	Short Print Cartridge Life	6-53
Table 7.1	Removal of Subassembly Parts	7-35
Table 8.1	Exploded View Parts List	8-3
Table 8.2	Subassembly Exploded Views Parts List	8-11
Table 8.3	Alphabetical Parts List	8-13
Table 8.4	Numerical Parts List	8-17
Table 8.5	Low Usage Kits	8-21
Table A.1	Language Abbreviations	A-1

List of Figures

Figure 1.1	Printer External View	1-9
Figure 1.2	Printable Area	1-11
Figure 2.1	Connecting Power to the Printer.....	2-2
Figure 2.2	Connecting via a USB Cable for Windows Users.....	2-3
Figure 2.3	Connecting via a USB Cable for Macintosh Users	2-4
Figure 2.4	Connecting via a Parallel Interface Cable	2-5
Figure 2.5	Self-Test Page	2-8
Figure 2.6	Connecting to an External Print Server	2-10
Figure 2.7	Printer Sharing in Windows	2-11
Figure 3.1	Printer Buttons and LEDs.....	3-2
Figure 4.1	Loading Paper in Main (Bottom) Media Tray.....	4-4
Figure 4.2	Loading Paper in Alternative (Top) Media Feed.....	4-5
Figure 4.3	Loading Paper Through Rear Media Feed	4-6
Figure 4.4	Clearing Paper Jams	4-7
Figure 5.1	Cleaning the Electrical Contacts	5-6
Figure 5.2	Changing the Print Cartridges	5-8
Figure 5.3	Removing Tape from Ink Nozzles.....	5-8
Figure 6.1	Clear Paper Jam.....	6-11
Figure 6.2	Load Media Correctly.....	6-11
Figure 6.3	Bypass Stopper.....	6-12
Figure 6.4	Load Media Correctly.....	6-13
Figure 6.5	Removing Protective Tape from Ink Nozzles.....	6-15
Figure 6.6	Load Media Correctly.....	6-22
Figure 6.7	Block Diagram of Electrical System.....	6-32
Figure 6.8	Cleaning Electrical Contacts.....	6-34
Figure 6.9	Removing Protective Tape from Ink Nozzles.....	6-50
Figure 6.10	Cleaning Electrical Contacts.....	6-51
Figure 6.11	Changing Print Cartridges	6-52
Figure 6.12	Removing Protective Tape from Ink Nozzles.....	6-53
Figure 6.13	Self-Test Page	6-60
Figure 6.14	Single Diagnostic Test Page.....	6-61
Figure 6.15	Nozzle Pattern Diagnostic Test Page	6-63
Figure 6.16	Calibration Diagnostic Test Page	6-65
Figure 6.17	Extended Diagnostic Test Page	6-67

Figure 6.18	Dot Count Diagnostic Test Page.....	6-68
Figure 6.19	Pen ID Diagnostic Test Page	6-69
Figure 6.20	Infinite Hs Diagnostic Test Page	6-70
Figure 6.21	Page Alignment Diagnostic Test Page	6-71
Figure 7.1	Removing the Output Tray and Stopper Assembly	7-6
Figure 7.2	Removing the Cleanout Trough Assembly	7-7
Figure 7.3	Removing the Stopper Guides	7-8
Figure 7.4	Removing the Access Door Assembly	7-9
Figure 7.5	Removing the Logic PCA Assembly	7-10
Figure 7.6	Removing the Left End Cap Assembly.....	7-11
Figure 7.7	Removing the Power Supply Assembly	7-12
Figure 7.8	Removing the Right End Cap Assembly	7-13
Figure 7.9	Removing the Keypanel PCA	7-14
Figure 7.10	Removing the Encoder Strip.....	7-17
Figure 7.11	Removing the Carriage Motor Assembly	7-18
Figure 7.12	Removing the Service Station Mechanism Assembly	7-19
Figure 7.13	Removing the Pivot Spring and Rocker Plate Spring	7-20
Figure 7.14	Removing the Rail Cover, Starwheels Assembly, and Output Mechanism Assembly.....	7-22
Figure 7.15	Removing the Input Tray Assembly	7-24
Figure 7.16	Removing the Pick Roller Assembly	7-25
Figure 7.17	Removing the Carriage Assembly/Carriage Rod	7-27
Figure 7.18	Removing the Upper Paper Guide Assembly.....	7-30
Figure 7.19	Removing the Drive Roller Assembly	7-31
Figure 7.20	Calibrating the Printer	7-38
Figure 8.1	Exploded View	8-2
Figure 8.2	Exploded Views of Access Door Assembly (A), Cleanout Trough Assembly (B), and Service Station Mechanism Assembly (C).....	8-7
Figure 8.3	Exploded Views of Power Supply Assembly (D), Carriage Assembly (E), and Drive Roller Assembly (F)	8-8
Figure 8.4	Exploded Views of Trough-1 Assembly (G) and Left Support Assembly (H)	8-9
Figure 8.5	Exploded Views of Backbone Assembly (J) and Spot Sensor Assembly (K)	8-10



List of Trees

Tree 6.1	Problems with a Network Printer	6-4
Tree 6.2	Printer is not Responding	6-6
Tree 6.3	Paper Feed Problems.....	6-10
Tree 6.4	A Blank Page is Printed	6-14
Tree 6.5	Troubleshooting Hardware Problems	6-29
Tree 6.6	Troubleshooting Power On Problems	6-30
Tree 6.7	Troubleshooting Printer Initialization Problems	6-33
Tree 6.8	Troubleshooting Using LEDs.....	6-36
Tree 6.9	Troubleshooting Paper Feed Problems	6-47
Tree 6.10	Troubleshooting the Self-Test.....	6-49
Tree 6.11	Troubleshooting Paper Eject Problems	6-55
Tree 6.12	Troubleshooting Unusual Noises	6-57
Tree 7.1	Disassembly Sequence	7-5



Preface

Conventions.....	xiv
Chapter Descriptions.....	xv

Conventions

This manual uses the following conventions:

The names of major printer parts and assemblies are **Capitalized**.

Italic type is used to show you where to find more information.

Bold type is used to indicate printer commands.

Note

Notes contain important information set off from the text.

Caution

Caution messages alert you to the possibility of damage to equipment.

WARNING!

Warning messages alert you to the possibility of personal injury.

Chapter Descriptions

Preface

The preface provides chapter descriptions and information on how to use this manual.

Chapter 1: Product Information

This chapter describes features of the printer, gives safety and regulatory information, and provides information on how to access service and support.

Chapter 2: Installing and Configuring the Printer

Learn how to get the printer ready for use. Connect the printer to a computer, install printer software and learn how to use the printer on a network.

Chapter 3: Printer Operation

Learn to use the key panel and the control panel, how to change default print settings and how to use the ToolBox to access basic troubleshooting and printer maintenance procedures.

Chapter 4: Paper Selection and Paper Loading

This chapter discusses what types of media to use with your printer and how to load media in to the printer.

Chapter 5: Printer Maintenance

This chapter discusses procedures for cleaning the printer and how to use print cartridges effectively.

Chapter 6: Troubleshooting

Learn how to effectively diagnose printer problems. This chapter shows service professionals how to help customers solve printer problems over the phone and how to work on printers returned for repair.

Chapter 7: Removal, Replacement and Calibration

Step-by-step procedures show how to replace field replaceable components in the printer and how to calibrate the printer.

Chapter 8: Parts and Diagrams

Exploded view drawings and part number listings are included for all replaceable parts in the printer. The composite table of replaceable parts is sorted alphabetically by part name, and also sorted numerically by part number. Both tables are cross-referenced to the diagrams in the chapter.

Index

The index is an alphabetical, cross-referenced listing of information found in the main body of the manual.

Product Information

Product Overview	1-2
Product Positioning	1-2
Model and Serial Number	1-2
Technology Update	1-2
Printer Description and Features	1-4
External View	1-9
Specifications.....	1-11
Hewlett-Packard Print Cartridge Specifications	1-11
Printable Area	1-11
Safety and Regulatory Notices.....	1-12
Print Cartridge Safety	1-12
Material Safety Data Sheet (MSDS).....	1-13
LED Safety	1-13
FCC Regulations	1-13
Power Cord Statement	1-14
Declaration of Conformity	1-15
Energy Consumption	1-16
Service and Support Information.....	1-17
Parts and Supplies	1-17
Media Products	1-19
HP Web Support.....	1-21
HP Telephone Support.....	1-21
HP ASAP	1-24
HP Express Exchange	1-24
Warranty	1-26
Hewlett-Packard Limited Warranty	1-26
Extent of Limited Warranty	1-26
Limitations of Warranty	1-27
Limitations of Liability	1-27
Local Law	1-28

Product Overview

Product Positioning

The HP DeskJet 1220C is designed to be the printer of choice for small businesses and offices that value printing on a wide range of media types and sizes. The HP DeskJet 1220C printer can print vibrant colors on paper up to 13" x 50" (330 mm x 1016 mm). It connects directly to IBM and IBM-compatible computers through a parallel port or a Universal Serial Bus (USB) port, and connects to Macintosh 68040 or later computers through a USB port. The printer can also be shared on a network.

Model and Serial Number

The serial number and the model number are listed on the identification label located on the back of the printer. The serial number contains information about the Country of Origin, the Revision Level, the Production Code, and the Production Number of the printer. The label also contains power rating and regulatory information.

Note

These values vary by region.

Technology Update

Thermal InkJet Technology

Thermal InkJet Technology is based on HP's disposable print cartridges. In each cartridge, there is a small reservoir, known as the firing chamber, filled with a tiny measure of ink. This ink is heated with a thin-film resistor layered above the firing chamber. As the ink heats up, it expands to form a bubble. The bubble expands until it bursts, at which point the ink is forced through the nozzle located below the firing chamber and out onto the paper. This process is repeated up to 12,000 times per second, and creates residual heat in the resistor. A layer of silicon is placed above the resistor to cool it by transferring the residual heat away.

HP black print cartridges (series C51645) contain 300 nozzles and HP color cartridges (series C6578) contain 432 nozzles (144 per color).

PhotoREt III

Photo Resolution Enhancement technology enables DeskJet printers to produce photo-quality color images. PhotoREt III's Color Layering technology

combines small ink-drop-volume print cartridges, vibrant, fade-resistant color inks, new halftoning algorithms, and specially developed HP Premium Plus Photo paper to deliver outstanding image quality and performance. The increased capacity of HP DeskJet 1220C printers to place up to 29 drops of ink in a single pixel creates finer color control and produces five times the number of colors produced by PhotoREt II printers.

ColorSmart III

ColorSmart III enables the printer driver to scan the contents (text, graphics, and images) of pages to generate optimal settings for each document printed. ColorSmart III further extends ColorSmart technology with new image-enhancement tools:

- HP SmartFocus—A new algorithm that improves image clarity in high-resolution files, as well as continues optimization for low-resolution images from the Internet or multimedia sources.
- HP Automatic Contrast Enhancement (ACE)—Brightens colors and sharpens details in images captured under poor lighting conditions.
- sRGB (standard Red, Green, Blue)—An industry peripheral color standard developed jointly by HP and Microsoft that improves color matching in peripheral devices that support the color standard.
- Intel MMX/SIMD technology—Allows the driver to process media-rich data in parallel for faster processing of color and image graphics.

Printer Description and Features

Table 1.1 Printer Description and Features

Print Method	Drop on-demand thermal inkjet printing		
Print Speed Black	Black text	Letter	Tabloid
	Fast Mode	11 ppm	7 ppm
	Normal Mode	6.8 ppm	4 ppm
	Best Mode	4.5 ppm	3 ppm
Print Speed Color	Mixed text with color graphics	Letter	Tabloid
	Fast Mode	9.5 ppm	6.4 ppm
	Normal Mode	5 ppm	3.3 ppm
	Best Mode	2.8 ppm	1.5 ppm
	Full page color	Letter	Tabloid
	Fast Mode	2.9 ppm	2 ppm
	Normal Mode	0.6 ppm	0.4 ppm
	Best Mode	0.3 ppm	0.2 ppm
	Color photo	4" x 6"	8" x 10"
	Normal	0.8 ppm	0.5 ppm
	Best	0.5 ppm	0.2 ppm
	Approximate figures. Exact speed depends on the system configuration, software program, and document complexity.		
	Black Resolution	Draft:	300 x 600 dpi
Normal:		600 x 600 dpi	
Best:		600 x 600 dpi	
Color Resolution	Draft:	300 x 600 dpi	
	Normal:	PhotoREt III	
	Best:	PhotoREt III**	
** A High Resolution Mode of 2400 x 1200 dpi is also available by unchecking PhotoREt when photo paper type is selected.			
Vertical Alignment	+/- 0.002" (0.051 mm)		

Table 1.1 Printer Description and Features

Printer Command Language	HP PCL Level 3 enhanced
Software Compatibility	Microsoft Windows® (3.1x, 95, 98, NT 4.0); Macintosh, MS-DOS applications
Fonts	8 built-in fonts: CG Times, CG Times Italic; Univers, Univers Italic; Courier, Courier Italic; Letter Gothic, Letter Gothic Italic (Euro Symbol Supported)
Smart Software Features	In-box printer driver features: HP ZoomSmart scaling technology, Tiling, Booklet, Handout (N-up printing), Manual Duplex, Banner, Mirror Image, Watermark*, Optimized for fax, Print Preview*, Sepia*, Quick Sets*, Schedule Printing**, ColorSync** Note: *Windows Only; **Macintosh Only

Table 1.1 Printer Description and Features

<p>Media Size/Type Supported</p>	<p>Paper: Plain, inkjet, photo, glossy: Super B 13" x 19" U.S. Tabloid 11" x 17" U.S. Legal 8.5" x 14" U.S. Letter 8.5" x 11" U.S. Executive 7.25" x 10.5" Statement 5.5" x 8.5" European A3 297 x 420 mm A4 210 x 297 mm A5 148.5 x 210mm JIS-B4 257 x 364 mm JIS-B5 182 x 257 mm</p> <p>Banner: U.S. Letter 8.5" x 11" European A4 210 x 297 mm U.S. Tabloid 11" x 17" A3 297 x 420 mm</p> <p>Transparencies: U.S. Letter 8.5" x 11" European A4 210 x 297 mm</p> <p>Envelopes: U.S. No. 10 4.12" x 9.5" U.S. A2 Invitation 4.37" x 5.57" U.S. Monarch 3.87" x 7.75" European DL 220 x 110 mm C5 162 x 229 mm Japanese Kaku #2 240 x 333 mm, #3 120 x 235 mm, #4 90 x 205 mm</p> <p>Cards: U.S. Index card 4" x 6" U.S. Index card 5" x 8" European A6 card 105 x 148.5 mm Japanese Hagaki Postcard 100 x 148 mm</p> <p>Labels: U.S. Labels 8.5" x 11" European A4 Labels 210 x 297 mm</p> <p>Custom Size: Width: 4" to 13" (102 to 330 mm) Length: 6" to 50" (152 to 1270 mm)</p>																				
<p>Media Handling</p>	<table border="0"> <tr> <td></td> <td style="text-align: center;">Sheets</td> <td style="text-align: center;">Envelopes</td> <td style="text-align: center;">Cards</td> </tr> <tr> <td>Main Paper Tray:</td> <td style="text-align: center;">Up to 150</td> <td style="text-align: center;">Up to 15</td> <td style="text-align: center;">Up to 60</td> </tr> <tr> <td>Alternative Top Tray:</td> <td style="text-align: center;">Up to 10</td> <td style="text-align: center;">Up to 3</td> <td style="text-align: center;">Up to 4</td> </tr> <tr> <td>Manual Feed:</td> <td colspan="3">Single sheet only</td> </tr> <tr> <td>Output Tray:</td> <td colspan="3">Up to 50 sheets</td> </tr> </table>		Sheets	Envelopes	Cards	Main Paper Tray:	Up to 150	Up to 15	Up to 60	Alternative Top Tray:	Up to 10	Up to 3	Up to 4	Manual Feed:	Single sheet only			Output Tray:	Up to 50 sheets		
	Sheets	Envelopes	Cards																		
Main Paper Tray:	Up to 150	Up to 15	Up to 60																		
Alternative Top Tray:	Up to 10	Up to 3	Up to 4																		
Manual Feed:	Single sheet only																				
Output Tray:	Up to 50 sheets																				

Table 1.1 Printer Description and Features

Recommended Media Weight	<p>Paper: 60 to 135 g/m² (16 to 36 lb. Bond) using main tray and alternative tray; 60 to 250 g/m² (16 to 67 lb. Bond) using rear media feed (up to 0.02" or 0.52 mm thickness using rear media feed)</p> <p>Envelopes: 75 to 90 g/m² (20 to 24 lb. Bond)</p> <p>Cardstock: 110 to 200 g/m² (110 lb. Index)</p>
I/O Interface	IEEE 1284–Centronics parallel compatible; Universal Serial Bus (Windows 98® and USB-connect Macintosh™)
Printer Memory	8MB of built-in RAM
Dimensions	<p>With paper tray closed: 592.3 mm (23.3") W x 233 mm (9.2") H x 381 mm (15.0") D</p> <p>With paper tray fully extended: 592.3 mm (23.3") W x 233 mm (9.2") H x 672 mm (26.5") D</p>
Weight	10 kg (22 lb.)
Reliability & Estimated Usage	5,000 pages/month
Power Supply	Built-in Universal Power Supply
Power Requirements	Power Modules: input voltage 100 to 240 VAC (±10%), 50/60 Hz (±3 Hz)
Power Consumption	1 watt maximum when off; 11.3 watts maximum non-printing; 47.7 watts maximum when printing
Operating Environment	<p>Operating temperature: 5° to 40°C (41° to 104°F)</p> <p>Recommended operating conditions: 15° to 35°C (59° to 95°F)</p> <p>Storage temperature: -40° to 60° C (-40° to 140°F)</p> <p>Relative Humidity: 20 to 80% RH non-condensing</p> <p>Noise levels per ISO 9296: Sound power LwAd: 5.8 B(A); Sound Pressure LpAm: 47 dB(A) (By-stander position)</p>

Table 1.1 Printer Description and Features

<p>System Requirements</p>	<p>Minimum: Windows 3.1x: 486 66MHz, 8MB RAM; Windows 95/98: Pentium 60MHz processor, 16MB RAM; Windows NT 4.0: Pentium 60MHz processor, 24MB RAM; MAC: OS 8.1 or above, USB-connect Macintosh only; OS 7.6.1 or above: Network via HP JetDirect only; MS-DOS: DOS 3.3 or above, 486 66MHz, 4MB RAM</p>
	<p>Recommended: Windows 3.1x: 486 66MHz processor, 8MB RAM; Windows 95/98: Pentium 300MHz processor, 32MB RAM; Windows NT 4.0: Pentium 300MHz processor, 64MB RAM; Power MAC G3: OS 8.6, 350MHz, 64MB RAM; iMac: OS 8.6, 333MHz, 32MB RAM; 50MB Free Hard Disk space for 11" x 17" or A3 size printing. High-resolution images and graphics-intensive files may require more disk space.</p>
<p>Warranty</p>	<p>1 year limited warranty</p>
<p>Product Certifications</p>	<p>Safety Certifications: CCIB (China), CSA (Canada), PSB (Singapore), UL (USA), NOM1-1-NYCE (Mexico), TUV-GS (Germany), SABS (South Africa), JUN (Korea), LS (Lithuania), EEI (Estonia), CE (European Union), B mark (Poland). EMI Certifications: FCC Title 47 CFR Part 15 Class B (USA), ICES-003 (Canada), CTICK (Australia & New Zealand), VCCI (Japan), CE (European Union), BCIQ (Taiwan), JUN (Korea) LS (Lithuania).</p> 

External View

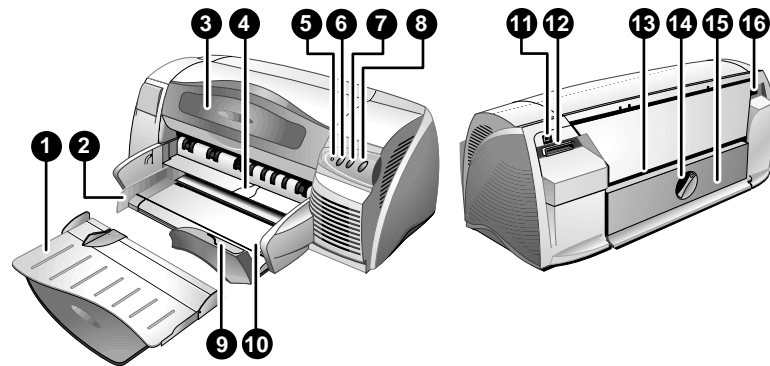

Figure 1.1 Printer External View

- 1** Output Tray—Collects the printed pages.
- 2** Paper Guides—Guides the paper into the printer.
- 3** Access Door—Gives access to the print cartridges and jammed paper.
- 4** Bypass Stopper—Lifts for inserting paper into the alternative top media feed.
- 5** Cartridge LED—Blinks when the Access Door is open or a cartridge error occurs.
- 6** Cancel Button—Cancels the current print job.
- 7** Resume Button—Blinks while waiting for a printed page to dry. Press it if you do not want to wait.
- 8** Power Button—Turns the power off and on.
- 9** Postcard Guide—Extends to guide short media into the printer.
- 10** Main paper tray—Holds the standard paper.
- 11** USB port—Jack for the Universal Serial Bus cable.
- 12** Parallel port—Jack for the parallel cable.
- 13** Rear media feed—Feeds thicker paper that requires a straight paper path.
- 14** Cleanout Trough knob—Turns counterclockwise for removing the Cleanout Trough, or clockwise to lock it.

15 Cleanout Trough–Alternate access to jammed paper.

16 Power input–Connector for the power cable.

Specifications

Hewlett-Packard Print Cartridge Specifications

The following specifications apply to Hewlett-Packard print cartridges used during plain paper drop-on-demand thermal inkjet printing.

Table 1.2 Hewlett-Packard Print Cartridge Specifications

Cartridge type	Black Large	Black	Color Large	Color
Part Number	51645A	51645G	C6578A	C6578D
Nozzles	300	300	408	408
Cartridge Life	18 months	18 months	18 months	18 months
Vertical Resolution	600 dpi	600 dpi	600 dpi	600 dpi
Ink Volume	42 ml	21 ml	42 ml	19 ml

Printable Area

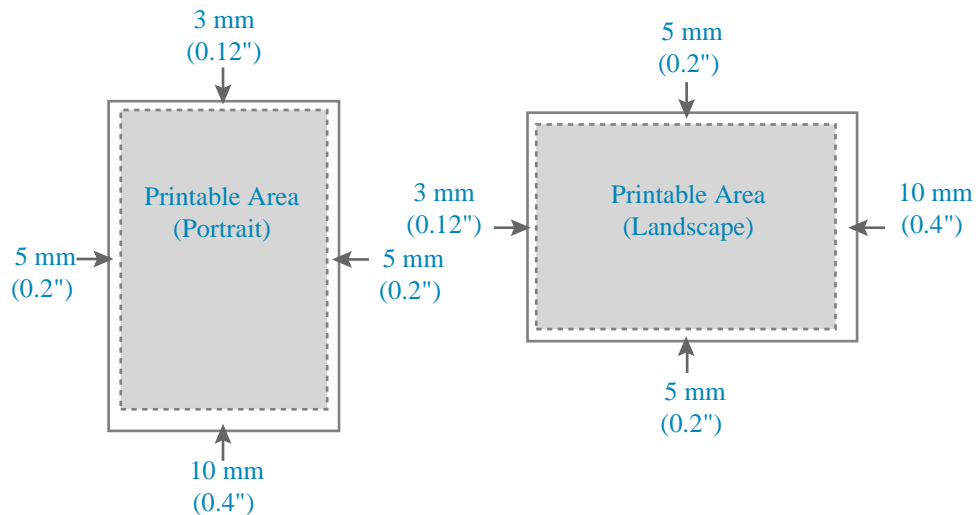

Figure 1.2 Printable Area

The printable areas apply to all media sizes.

Safety and Regulatory Notices

To reduce risk of injury from fire or electric shock, always follow basic safety precautions when using or servicing this printer.

- 1 Read and understand all instructions in the Service and Support Manual.
- 2 Observe all warnings and instructions marked on the printer.
- 3 Unplug the printer from wall outlet before cleaning.
- 4 Do not install, service, or use the printer near water, or when you are wet.
- 5 Install the printer securely on a stable surface.
- 6 Install the printer in a protected location where no one can step on or trip over the power cord, and the power cord cannot be damaged.
- 7 If the printer does not operate normally, see *Chapter 6: Troubleshooting*.
- 8 There are no user-serviceable parts inside the printer. Refer servicing to qualified service personnel.

Visit www.hp.com/abouthp/environment/contents/envfacts.htm for more information about safety and the environment.

Print Cartridge Safety

Ink used in the print cartridge does not pose a health hazard except as noted below. During the development of ink formulas, all ingredients are researched for known potential health related issues. Only chemicals that meet or exceed worldwide safety and regulatory requirements are used in HP inks.

WARNING!

The ink in the print cartridges contains diethylene glycol which may be harmful if swallowed. Keep new and used cartridges out of the reach of children. If ink is accidentally ingested, contact the 24 hour HP Health Line:

800-457-4209 (within U.S.)
503-494-7199 (outside U.S.)

Material Safety Data Sheet (MSDS)

Material Safety Data Sheets for the ink are available. Request an MSDS from:

Hewlett-Packard Customer Information Center
Department MSDS
19310 Pruneridge Avenue
Cupertino, CA 95014
Mailstop 49AS
Telephone: 1-800-752-0900

Material Safety Data Sheets are also available from Customer Support Centers. See *Service and Support Information* on page 1-17 for information on contacting these resources.

LED Safety

The printer LEDs (light emitting diode) on the keypanel of this printer are classified as Class 1 LED devices according to International Standard IEC 825-1 (EN 60825-1). These devices are not considered harmful, but the following precautions are recommended:

- Be aware that the beam is invisible light and cannot be seen.
- Avoid direct eye exposure to the infrared LED beam.
- Do not attempt to view the infrared LED beam with any type of optical device.

FCC Regulations

This equipment has been tested and found to comply with the specifications of Part 15 of the FCC rules. These limits are designed to provide reasonable protection against harmful interference in a residential installation. This equipment generates, uses, and can radiate radio frequency energy, and if not installed and used in accordance with the instructions, may cause harmful interference to radio communications. However, there is no guarantee that interference will not occur in a particular installation. If this equipment does cause harmful interference to radio or television reception, which can be determined by turning the equipment off and on, the user is encouraged to try to correct the interference by one or more of the following measures:

- Reorient or relocate receiving antenna.

- Increase separation between equipment and receiver.
- Connect equipment to an outlet on a circuit different from that to which the receiver is connected.
- Consult your dealer or an experienced radio/TV technician.

Power Cord Statement

The power cord cannot be repaired. If it is defective, it should be discarded or returned to the supplier.

Declaration of Conformity

According to ISO / IEC Guide 22 and EN 45104:

Manufacturer's name: Hewlett-Packard Singapore (Pte) Ltd.
Manufacturer's address: Asia Hardcopy Manufacturing Operation
20 Gul Way Singapore 629196

declares, that the product

Product Name: HP 1220C
Product Number: C2693A
Product Options: All

conforms to the following Product Specifications:

Safety: IEC 950: 1991 + A1 + A2 / EN 60950: 1992 + A1 + A2
IEC825-1: 1993 / EN 60825-1: 1994 class I for LEDS
EMC:CISPR 22: 1993 / EN 55022: 1994 Class B
EN 50082-1: 1992
IEC 801-2: 1991 / prEN 55024-2: 1992 - 4 kV CD, 8 kV CD
IEC 801-3: 1984 / prEN 55024-3: 1991 - 3 V/m
IEC 801-4: 1988 / prEN 55024-4: 1992 - 0.5 kV Signal Lines
1 kV Power Lines
IEC-1000-3-2: 1995 / EN 61000-3-2: 1995
IEC-1000-3-3: 1994 / EN 61000-3-3: 1995

Supplementary Information:

- 1 The products herewith comply with the requirements of the Low Voltage Directive 73 / 23 / EEC and the EMC Directive 89 / 336 / EEC.
- 2 The HP DeskJet 1220C printer was tested in a typical configuration with a Hewlett-Packard Personal Computer.

Singapore, December 1997 Chan Kum Yew, Quality Manager

European Contact: Your local Hewlett-Packard Sales and Service Office or:

Hewlett-Packard GmbH, Department TRE
Herrenberger Straße 130
D-71034 Boblingen
Germany
(Fax: +49-7031-143143)

Energy Consumption

Hewlett-Packard Company is committed to providing quality products in an environmentally sound manner. This product qualifies for ENERGY STAR. ENERGY STAR is a voluntary program established to encourage the development of energy-efficient office products.



ENERGY STAR is a US registered service mark of the US EPA.

この装置は、情報処理装置等電波障害自主規制協議会（VCCI）の基準に基づくクラスB情報技術装置です。この装置は、家庭環境で使用することを目的としていますが、この装置がラジオやテレビジョン受信機に近接して使用されると受信障害を引き起こすことがあります。
取り扱い説明書に従って正しい取り扱いをして下さい。

Service and Support Information

Parts and Supplies

Printer part numbers are listed in *Chapter 8: Parts and Diagrams*.

Table 1.3 Printer Parts

Description	Part Number
HP DeskJet 1220C Printer	C2693A
HP DeskJet 1220Cxi Printer	C2694A
HP DeskJet 1220Cse Printer	C2695A
Black Inkjet Cartridge (21 ml)	51645G
Black Inkjet Cartridge (42 ml)	51645A
Color Inkjet Cartridge (19 ml)	C6578D
Color Inkjet Cartridge (42 ml)	C6578A
HP IEEE-1284 A-B Parallel Cable (2 m)	C2950A
HP IEEE-1284 A-B Parallel Cable (3 m)	C2951A
HP USB A-B (2 m)	C6518A
HP JetDirect 170X external print server	J3258A
HP JetDirect 300X external print server	J3263A
AC Power Cord – European	8121-0023
AC Power Cord – US	8121-8900
AC Power Cord – UK	8121-0022
AC Power Cord – South Africa	8121-0020
AC Power Cord – Australia/New Zealand	8121-0018
AC Power Cord – South Pacific/Malaysia/Hong Kong	8121-0026
AC Power Cord – India	8121-0025
AC Power Cord – Korea	8121-0017

Table 1.3 Printer Parts

AC Power Cord – Chile	8121-8452
AC Power Cord – Japan	8121-0021
AC Power Cord – Argentina	8121-0019
AC Power Cord – Philippines	8121-0024

Media Products

Table 1.4 Media Products

Description	Size	Part Number
HP Bright White Inkjet Paper		
US B-size, 200 sheets	11" x 17"	C1857A
A3, 200 sheets	297 x 420 mm	C1858A
US Letter, 500 sheets	8.5" x 11"	C1824A
A4, 500 sheets	210 x 297 mm	C1825A
HP Premium Inkjet Paper		
US B-size, 100 sheets	11" x 17"	C1855A
A3, 100 sheets	297 x 420 mm	C1856A
US Letter, 200 sheets	8.5" x 11"	51634Y
A4, 200 sheets	210 x 297 mm	51634Z
HP Premium Heavyweight Inkjet Paper		
US Letter, 100 sheets	8.5" x 11"	C1852A
A4, 100 sheets	210 x 297 mm	C1853A
HP Premium Photo Paper		
US B-size, 15 sheets	11" x 17"	C6058A
A3, 15 sheets	297 x 420 mm	C6059A
US Letter, 15 sheets	8.5" x 11"	C6039A
A4 (European), 15 sheets	210 x 297 mm	C6040A
A4 (Asian), 15 sheets	210 x 297 mm	C6043A
HP Premium Plus Photo Paper		
US Letter, Glossy, 20 sheets	8.5" x 11"	C6831A
A4, Glossy, 20 sheets	210 x 297 mm	C6832A
Snapshot, Glossy, 20 sheets	4" x 6"	C6944A
US Letter, Matte, 20 sheets	8.5" x 11"	C6950A
A4, Matte, 20 sheets	210 x 297 mm	C6951A
HP Professional Brochure and Flyer Paper		
US Letter, Glossy, 50 sheets	8.5" x 11"	C6817A
A4, Glossy, 50 sheets	210 x 297 mm	C6818A
US Letter, Matte, 50 sheets	8.5" x 11"	C6955A
Tabloid, Glossy, 50 sheets (US only)	11" x 17"	C6820A
A3, Glossy, 50 sheets (Europe only)	297 x 420 mm	C6821A
HP Premium Transparency Film		
US Letter, 50 sheets	8.5" x 11"	C3834A
US Letter, 20 sheets	8.5" x 11"	C3828A
A4, 50 sheets	210 x 297 mm	C3835A
A4, 20 sheets	210 x 297 mm	C3832A

Table 1.4 Media Products

HP Banner Paper		
US Letter, 100 sheets	8.5" x 11"	C1820A
A4, 100 sheets	210 x 297 mm	C1821A
HP Iron-on T-shirt Transfers		
US Letter, 10 sheets	8.5" x 11"	C6049A
A4, 10 sheets	210 x 297 mm	C6050A
HP Greeting Card Paper		
US Letter, 20 sheets, 20 envelopes		C1812A
A4, 20 sheets, 20 envelopes		C6042A
HP Felt-Textured Greeting Cards, Ivory/Half-fold		
US Letter, 20 sheets, 20 envelopes		C6828A
HP Glossy Greeting Card Paper		
US Letter, 10 sheets, 10 envelopes		C6044A
A4, 10 sheets, 10 envelopes		C6045A
HP Restickables		
US Letter, Large round, 9/sheet, 10 sheets		C6822A
US Letter, Large square, 9/sheet, 10 sheets		C6823A

Ordering Parts

Table 1.5 Ordering Parts

Parts Direct Ordering	Parts Center Europe
Hewlett-Packard Company Support Materials Organization 8050 Foothills Blvd. Roseville, CA 95678 1-800-227-8164 (U.S. only)	Hewlett-Packard Company Parts Center Europe Wolf-Hirth Strasse 33 D-7030 Boeblingen, Germany (49 7031) 14-2253

Ordering Supplies

You can order HP supplies and accessories from HP on the World Wide Web. Visit the HP Outlet Center (<http://www.hpshopping.com>) for more information.

Telephone numbers for ordering supplies are as follows:

Table 1.6 Ordering Supplies

U.S.	1-800-538-8787
Canada	1-800-387-3154
Toronto	1-416-671-8383
United Kingdom	0734-441212
Germany	0130-3322

HP Web Support

Visit the World Wide Web for the latest printer software, product, operating system, and support information:

- <http://www.hp.com/go/dj1220C>
- <http://www.hp.com/cposupport>

HP Telephone Support

You may obtain assistance from the HP Customer Care Center. Before calling, please fill in the following information to be ready to help your Customer Care Center representative:

Table 1.7 HP Telephone Support

What is the serial number of your printer (check the back of your printer)?	
What model printer do you have?	
What is the brand and model of your computer?	
What version of the printer software are you using? (Open the printer driver Properties , click Preference , and then click About .)	
What driver did you select?	

Table 1.7 HP Telephone Support

Run the Toolbox software utility and select the Information tab .	
--	--

Have this information ready when you call the following support lines:

Customer Support in the US

Table 1.8 Customer Support in the US

During Warranty:	208-323-2551 Monday through Friday 6 AM to 6 PM (MST)
Post Warranty:	900-555-1500 (In Canada: 877-621-4722) Monday through Friday 7 AM to 6 PM (MST) \$2.50 per minute, maximum \$25.00; or 800-999-1148 charged to Visa or Master Card, \$25.00 per call

Customer Support outside the US

Table 1.9 Customer Support outside the US

Africa/Middle East +41- 22/780-71-11	Argentina 541-781-4061/69
Australia 613-8877-8000	Austria 0660-6386
Belgium (Dutch) 02-6268806	Belgium (French) 02-6268807
Brazil 55-11-709-1444	Canada 905-206-4663
China 86-10-6505-3888	Czech Republic 42-(2)-471-7327
Denmark 3929-4099	Finland 0203-47-288
France 01-43-62-34-34	Germany 0180-52-58-143
Greece 01-68-96-4-11	Hong Kong 800-96-7729
Hungary 36-(1)-252-4505	India 9111-682-6035
Indonesia 21-350-3408	Ireland 01-662-5525
Italy 02-264-10350	Korea 822-3270-0700
Malaysia 03-295-2566	Mexico D.F. 01-800-2214700, 01-800-9052900
New Zealand 09-356-6640	Norway 22-11-6299
Philippines 2-867-3551	Poland 022-37-5065, 48-22-37-5065
Portugal 01-441-7-199	Russia 7095-923-50-01
Singapore 272-5300	Spain 902-321-123
Sweden 08-619-2170	Switzerland 0848-80-11-11
Taiwan 886-2-27170055	Thailand 02-661-4011
The Netherlands 020-606-8751	Turkey 90-1-224-59-25

Table 1.9 Customer Support outside the US

United Kingdom 0171-512-5202	Vietnam 8-823-4530
Venezuela 582-239-5664	

HP ASAP

HP ASAP (Automated Support Access Program) provides free technical support information 24 hours a day, 7 days a week. HP ASAP includes HP AUDIO-TIPS.

Note

HP ASAP requires a touch tone telephone.

HP AUDIO-TIPS

HP AUDIO-TIPS, available within HP ASAP, is an interactive voice response system providing pre-recorded answers to the questions most frequently asked by HP DeskJet printer users. Helpful “System Maps” to the HP AUDIO-TIPS recordings are available by fax through HP FIRST.

To use HP AUDIO-TIPS in the U.S. call HP ASAP and follow the instructions. The telephone number for HP ASAP in the U.S. is 1-800-333-1917. For all other areas, contact the local service provider.

To use HP AUDIO-TIPS in Europe, call HP ASAP and follow the instructions. The telephone numbers for HP ASAP in Europe are as follows:

Table 1.10 HP AUDIO-TIPS in Europe

United Kingdom	0800-96-02-71
Belgium (Dutch)	078-111906
Switzerland (German)	155-1527
Netherlands	06-0222420
Germany	0130-810061
Austria	0660-8128
For English service outside the above countries, (31) 20-681-5792HP ASAP.	

HP Express Exchange

Through Customer Care Centers in the United States and Canada, customers

have the option to initiate Express Exchange. Under this option, customers may have a factory refurbished printer sent to them within 24 hours.

- 1** The customer contacts the local HP Customer Care Center. A technician troubleshoots the situation and determines whether the printer has failed. If so, the technician refers the customer to the HP Service Center.
- 2** A representative from the service center requests product and customer information. In some regions, collateral may also be requested.
- 3** HP ships a refurbished replacement unit to arrive the next day; geographic distance might prevent next-day shipping.
- 4** The customer sends the defective printer to Hewlett-Packard at HP's expense. Customers with on-site support service provided by HP should work directly with the local Customer Care Center instead of following the steps outlined here. Exchanged units carry the remainder of the original unit's warranty or 90 days, whichever is greater. The faster turnaround from HP Express Exchange minimizes downtime over traditional service programs that require the user to ship the failed unit to the manufacturer, and then wait for it to be repaired and returned. Because HP pays the shipping charges, the user incurs no hidden costs for the service.

Warranty

Hewlett-Packard Limited Warranty

Table 1.11 Hewlett-Packard Limited Warranty

HP Product	Duration of Limited Warranty
Software	90 days
Print Cartridges	90 days
Printer Peripheral Hardware – see below for details	1 Year

Extent of Limited Warranty

- 1 Hewlett-Packard warrants to the end-user customer that the HP products specified above will be free from defects in materials and workmanship for the duration specified above, which duration begins on the date of purchase by the customer.
- 2 For software products, HP's limited warranty applies only to a failure to execute programming instructions. HP does not warrant that the operation of any product will be uninterrupted or error free.
- 3 HP's limited warranty covers only those defects that arise as a result of normal use of the product, and does not cover any other problems, including those that arise as a result of:
 - Improper maintenance or modification;
 - Software, media, parts, or supplies not provided or supported by HP; or
 - Operation outside the product's specifications.
- 4 For HP printer products, the use of a non-HP ink cartridge or a refilled ink cartridge does not affect either the warranty to the customer or any HP support contract with the customer. However, if printer failure or damage is attributable to the use of a non-HP or refilled ink cartridge, HP will charge its standard time and materials charges to service the printer for the particular failure or damage.

- 5 If HP receives, during the applicable warranty period, notice of a defect in any product which is covered by HP's warranty, HP shall either repair or replace the product, at HP's option.
- 6 If HP is unable to repair or replace, as applicable, a defective product which is covered by HP's warranty, HP shall, within a reasonable time after being notified of the defect, refund the purchase price for the product.
- 7 HP shall have no obligation to repair, replace, or refund until the customer returns the defective product to HP.
- 8 Any replacement product may be either new or like new, provided that it has functionality at least equal to that of the product being replaced.
- 9 HP products may contain remanufactured parts, components, or materials equivalent to new in performance.
- 10 HP's Limited Warranty Statement is valid in any country where the covered HP product is distributed by HP. Contracts for additional warranty services, such as on-site service, are available from any authorized HP service facility in countries where the product is distributed by HP or by an authorized importer.

Limitations of Warranty

TO THE EXTENT ALLOWED BY LOCAL LAW, NEITHER HP NOR ITS THIRD PARTY SUPPLIERS MAKES ANY OTHER WARRANTY OR CONDITION OF ANY KIND, WHETHER EXPRESS OR IMPLIED WARRANTIES OR CONDITIONS OF MERCHANTABILITY, SATISFACTORY QUALITY, AND FITNESS FOR A PARTICULAR PURPOSE.

Limitations of Liability

- 1 To the extent allowed by local law, the remedies provided in this Warranty Statement are the customer's sole and exclusive remedies.
- 2 TO THE EXTENT ALLOWED BY LOCAL LAW, EXCEPT FOR THE OBLIGATIONS SPECIFICALLY SET FORTH IN THIS WARRANTY STATEMENT, IN NO EVENT SHALL HP OR ITS THIRD PARTY SUPPLIERS BE LIABLE FOR DIRECT, INDIRECT, SPECIAL, INCIDENTAL, OR CONSEQUENTIAL DAMAGES, WHETHER BASED ON CONTRACT, TORT, OR ANY OTHER LEGAL THEORY AND WHETHER ADVISED OF THE POSSIBILITY OF SUCH DAMAGES.

Local Law

- 1 This Warranty Statement gives the customer specific legal rights. The customer may also have other rights which vary from state to state in the United States, from province to province in Canada, and from country to country elsewhere in the world.
- 2 To the extent that this Warranty Statement is inconsistent with local law, this Warranty Statement shall be deemed modified to be consistent with such local law. Under such local law, certain disclaimers and limitations of this Warranty Statement may not apply to the customer. For example, some states in the United States, as well as some governments outside the United States (including provinces in Canada), may:
 - Preclude the disclaimers and limitations in this Warranty Statement from limiting the statutory rights of a customer (e.g. the United Kingdom);
 - Otherwise restrict the ability of a manufacturer to enforce such disclaimers or limitations; or
 - Grant the customer additional warranty rights, specify the duration of implied warranties which the manufacturer cannot disclaim, or allow limitations on the duration of implied warranties.
- 3 FOR CONSUMER TRANSACTIONS IN AUSTRALIA AND NEW ZEALAND, THE TERMS IN THIS WARRANTY STATEMENT, EXCEPT TO THE EXTENT LAWFULLY PERMITTED, DO NOT EXCLUDE, RESTRICT, OR MODIFY, AND ARE IN ADDITION TO, THE MANDATORY STATUTORY RIGHTS APPLICABLE TO THE SALE OF THE HP PRODUCTS TO SUCH CUSTOMERS.

Installing and Configuring the Printer

Connecting Power to the Printer	2-2
Printing a Sample Page	2-2
Connecting the Interface Cable.....	2-3
Connecting via a USB Cable.....	2-3
Connecting via a Parallel Interface Cable.....	2-5
Installing Printer Software.....	2-6
Installing from the Starter CD (Recommended)	2-6
Verifying Communication in Windows	2-8
Printing a Self-Test Page.....	2-8
Checking the Interface Cable Connection	2-9
Using the Printer on a Network.....	2-10
Connecting to an External Print Server.....	2-10
Printer Sharing in Windows	2-11
Uninstalling Printer Software	2-13
For Windows 95/98/NT 4.0 Users	2-13
For Macintosh Users	2-13

Connecting Power to the Printer

Connect power to your printer by connecting the power cord to a standard wall outlet and to the power input socket on the printer. To check that power is connected, press the Power Button.

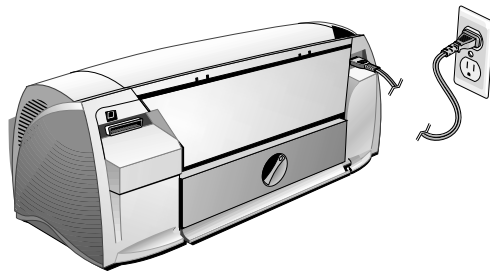

Figure 2.1 Connecting Power to the Printer

Printing a Sample Page

After you install the print cartridges and load paper into the printer, print a Sample page without being connected to a computer. This allows you to see that your printer is set up correctly.

- 1 Turn off the printer, and then turn it on again by pressing the Power Button.
- 2 Press the Resume Button and release it when the Resume Light turns off. Your printer prints a Sample page.

Connecting the Interface Cable

A good interface cable connection is important. The printer software uses a two-way communication connection to allow the computer to monitor the printer's status and to provide quick recovery from printing problems.

You must connect the printer to your computer using either a USB cable or a parallel cable prior to installing the Printer Software.

Connecting via a USB Cable

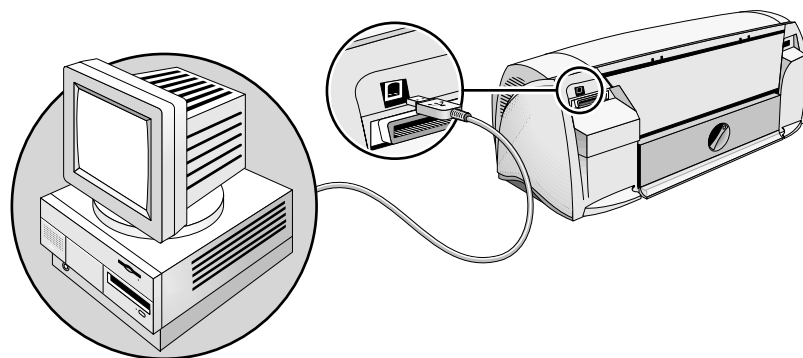

Figure 2.2 Connecting via a USB Cable for Windows Users

Note

USB cables, such as an HP USB-Compliant Interface Cable (part number C6518A), must be purchased separately.

For Windows 98 Users

The latest IBM or IBM-compatible computers have USB ports that can be directly connected to the printer's USB port. After connecting the USB cable, the New Hardware Found Wizard should appear. If it does not, your computer is probably not configured to use USB. Use a parallel cable instead to connect the printer to your computer.

- 1 Insert the HP Printer Starter CD into your CD-ROM drive. Do *not* click the printer installation icon. Proceed to step two.
- 2 Turn off the printer and connect the USB cable.
- 3 Turn on the printer. If the computer is properly configured to use USB, Windows will detect the printer.

- 4 The Add New Hardware Wizard dialog box appears.
 - a Click **Next** until you are asked to specify a location for the software.
 - b Click **Browse**, double-click on the CD icon (typically the D: drive), click on the **Windows\Win98usb** directory, and then click **OK**.
 - c Click **Next** to see the subsequent dialog boxes, and click **Finish**.
 - d Click **Back** if Windows was unable to locate a driver and repeat steps 4a to 4c. If the Add New Hardware Wizard screen disappears before completing the installation, detach and reattach the USB cable, and repeat step 4.
- 5 Install the printer software. Click **Next** and follow the instructions that appear on the screen to complete the installation.

Note

Do not connect a USB and a parallel cable to the printer at the same time.

For Macintosh Users

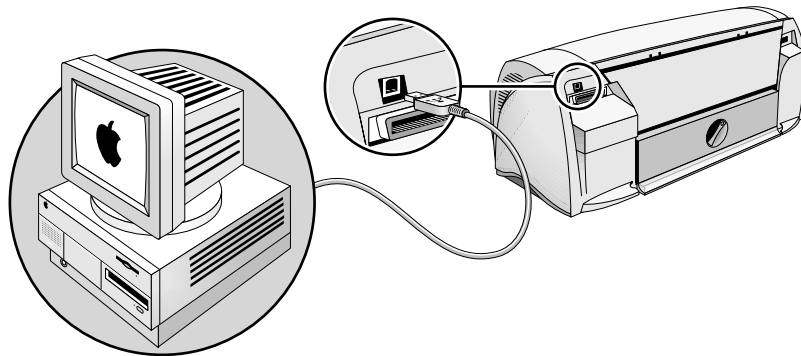

Figure 2.3 Connecting via a USB Cable for Macintosh Users

You can connect the printer to the latest models of Macintosh computers (Mac OS 8.1 or later) through the USB port. To connect older models without a USB port, you can either connect the Macintosh to a HP JetDirect print server (Jet-Direct 300x), or contact Apple for USB solutions.

Note

Not all USB cards are supported by Apple. Contact Apple for information on supported USB Cards.

Before connecting your printer to the computer, ensure that your configuration meets the requirements below. If your configuration meets these requirements, connect the USB cable to the printer and the computer and proceed to install the printer software.

- Your computer must support USB.
- You need a USB-compliant interface cable.
- Your computer must be running MacOS 8.1 or later.

Connecting via a Parallel Interface Cable

For Windows Users

- 1 Power off the printer.
- 2 Connect the cable to the parallel interface port on the computer. Tighten the screws on the connector to secure the cable to the computer.
- 3 Connect the cable to the printer's parallel port.
- 4 Press the Power Button to power on the printer.

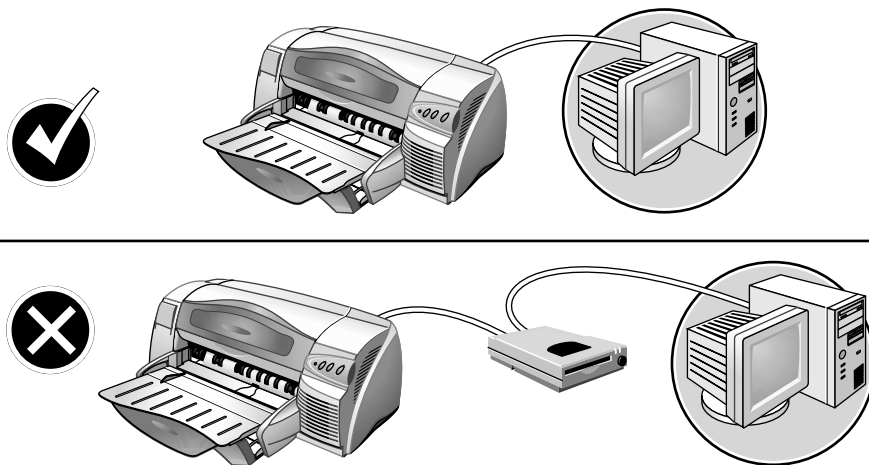

Figure 2.4 Connecting via a Parallel Interface Cable

Note

Make sure the parallel cable is connected directly to the printer parallel port. Do not share the port with other devices such as a Zip drive.

Installing Printer Software

After installation, you can access the printer driver through Windows, Macintosh, or from your software application. Although access to the printer driver from your software applications may vary, the printer driver is usually accessed from the File menu.

Installing from the Starter CD (Recommended)

The Starter CD includes printer software, a quick tour of your printer, an electronic copy of the User's Guide, and ordering information.

Note

The Starter CD also includes a utility that copies the software to 3.5" high-density diskettes or to a server for later installation.

For Windows 95/98/NT 4.0 Users

After you install the printer software, the HP 1220C ToolBox icon will appear on the desktop or in the HP Printer program group. See *Using the HP 1220C ToolBox* on page 3-7.

For Windows NT 4.0 users, you must have administrator privileges to install a printer.

For Windows 95 and Windows 98 users:

- If you see the message **New Hardware Found** at any time while installing the printer software, select **Do not install a driver (Windows will not prompt you again)** and click **OK**. Follow the instructions below to install the printer software.
- If you see the **Update Device Driver Wizard** dialog box, click **Next** until you have a **Finish** option and then click **Finish**. Follow the instructions below to install the printer software.

To install the printer software:

- 1 Start Microsoft Windows.
- 2 Insert the Starter CD into the CD-ROM drive. The installation program runs automatically.

If the installation program does not run automatically, click **Start**, select **Run**, and in the command line box, type the letter of your computer's CD-ROM drive followed by: \SETUP (for example, type D:\SETUP).

- 3 Click **Install Network Printer or Printer driver**. Follow the instructions that appear on the screen to complete the printer driver installation.

For Windows 3.1 Users

- 1 Start Microsoft Windows.
- 2 Insert the CD into the CD-ROM drive.
- 3 In the Program Manager window, click **File** and then select **Run**.
- 4 At the command line box, type the letter of your CD-ROM drive followed by `\WIN31\PCL3\<language>\SETUP.EXE`, where `<language>` is a 3-character code. For example, type `D:\WIN31\PCL3\ENU\SETUP.EXE`, where `ENU` is the code for English.

Note

See appendix for a list of 3-character language codes.

- 5 Follow the instructions that appear on the screen to complete the driver installation.

For Macintosh Users

- 1 Insert the Starter CD into the CD-ROM drive and double-click the Installer icon.
- 2 Follow the instructions on the screen to complete the installation.
- 3 Select **Chooser** from the **Apple** menu.
- 4 Click the printer's icon on the left side of the Chooser window. Then, click **HP 1220C** on the right side of the Chooser window, and close the Chooser window.

Verifying Communication in Windows

Printing a Self-Test Page

Print a Self-Test Page to determine if the printer software is properly installed.

- 1 Open the **Printers** folder.
- 2 Right click your printer, and then select **Properties** from the pop-up menu.
- 3 Select **Print Test Page**. The printer will print the following page.

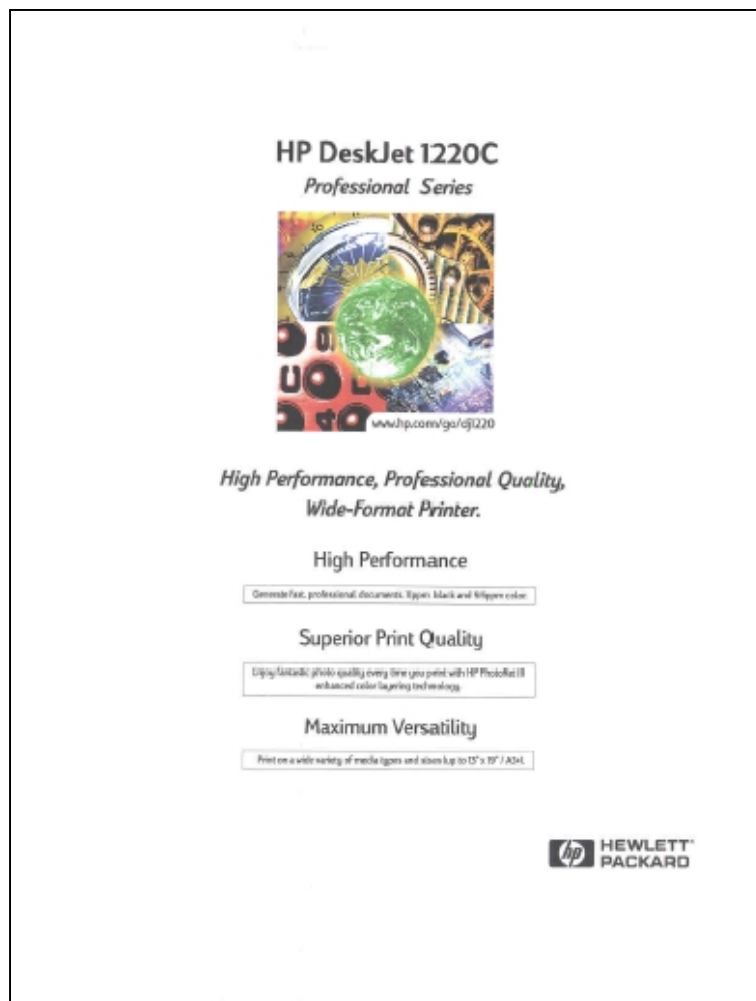

Figure 2.5 Self-Test Page

Checking the Interface Cable Connection

To check the two-way connection, follow these steps:

- 1 Make sure the printer cable is firmly connected to the printer and computer.
- 2 Double-click the Toolbox icon on the desktop or from the HP DeskJet 1220C Printer program menu.
- 3 Click **Printer Services** and then click **Test Printer Communication**.
- 4 Follow the on-screen instructions to complete the test.

Using the Printer on a Network

The printer can be shared in a network environment by connecting it directly to a network via an optional HP JetDirect external print server or by using printer sharing methods available in Windows. For information about installation and setup of HP JetDirect print servers, refer to your HP JetDirect Hardware and Software Installation Guides.

Note

The HP JetDirect external print server connects via the parallel port to the printer. The USB port will not work if a printer is connected to the network. Some print driver features do not work on a network printer. For example, the printer is unable to retrieve printer status messages over the network, such as checking ink levels, or reporting paper jams.

Connecting to an External Print Server

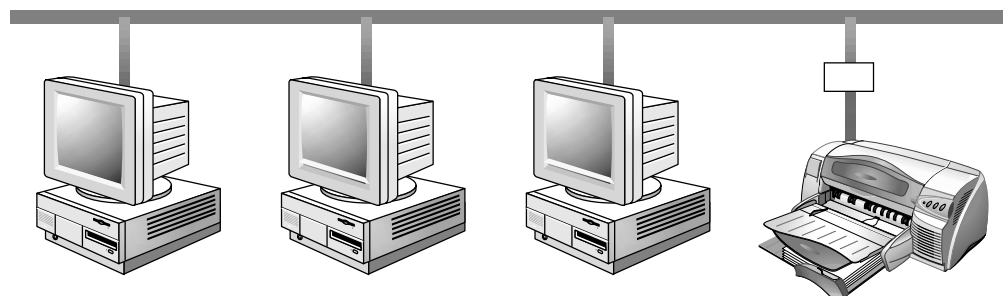

Figure 2.6 Connecting to an External Print Server

For Windows Users

If you have already installed the printer software and you want to connect to a JetDirect port:

- 1 Insert the HP JetDirect CD-ROM into your CD-ROM drive.
- 2 Select the option to install JetAdmin and follow the instructions on the screen.
- 3 Select **HP 1220C Printer** in the Printers folder.
- 4 Click the right mouse button and select **Properties**.
- 5 Click **Details** and then click **Add Port**.

6 Select a new JetDirect port and assign it to the printer.

7 Click **OK**.

For Macintosh Users

Note

Use an HP JetDirect 300X or 500X external print server on a Macintosh (ethernet) network or a mixed Macintosh and PC network environment.

If you have already installed the printer software and you want to connect to a JetDirect port:

- 1 Insert the HP JetDirect CD-ROM into your CD-ROM drive.
- 2 Select the option to install JetAdmin and follow the instructions on the screen.

Visit the world wide web at hp.com/go/mac-connect for more information about Macintosh solutions.

Printer Sharing in Windows

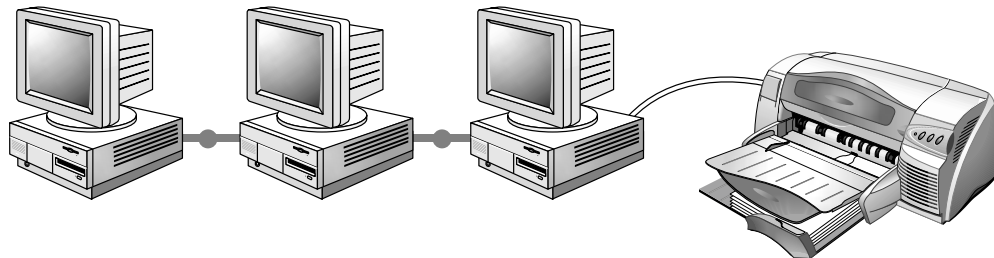

Figure 2.7 Printer Sharing in Windows

Note

Although alternate installation methods are described below, the Starter CD is all you need to guide you through a shared printer installation.

To install a network printer with the **Add Printer** command:

- 1 Click **Start**, select **Settings**, and then select **Printers**.
- 2 Double-click **Add Printer**.
- 3 In Windows 95/98, select **Network Printer**. In Windows NT 4.0, select **Network Printer Server** when prompted.

- 4 Type in the network path or queue name of the shared printer. Click the **Have Disk...** option when prompted to select the printer model.
- 5 Click **Browse...** and locate the HP1220C.INF file. This file contains the printer name for you to select. The file is located on the Starter CD in Windows\PCI3\winnt\enu or Windows\PCI3\win9x\enu. If you need help, contact your System Administrator.
- 6 The Installation Option screen appears. Follow the instructions on the screen to complete the PC configuration process.

Uninstalling Printer Software

For Windows 95/98/NT 4.0 Users

For parallel port or network connections in Windows 95, 98, and NT 4.0:

- 1 From the HP 1220C Printer folder and double-click the HP1220C Uninstaller icon.
- 2 Follow the instructions that appear on the screen to complete uninstallation of the printer software.
- 3 After uninstallation, restart Windows.

Note

You must have administrator privileges to uninstall the printer software in the Windows NT 4.0.

For USB connections, follow the steps above, and restart Windows. If the software was not successfully installed, or the Uninstaller could not be found:

- 1 Install the printer software for a *parallel* port connection (LPT1) using the Starter CD.
- 2 After installation is complete, uninstall the software as described above. This will also remove previously failed USB installations.
- 3 Restart Windows to complete the removal of the printer software.

For Macintosh Users

- 1 From the **Apple** menu, click **Control Panels**.
- 2 From Control Panels, click **Extensions Manager**.
- 3 Under Extensions, click to deselect **HP 1220C**, and then close **Extensions Manager**.
- 4 Restart your Macintosh to complete the uninstall.

Printer Operation

Using the Keypanel	3-2
Printer Buttons and LEDs	3-2
Using the Control Panel	3-4
Changing Default Print Settings	3-4
Restoring Factory Defaults	3-4
Using the HP DeskJet Control Panel for DOS.....	3-6
Installing the HP DeskJet Control Panel for DOS	3-6
Changing Print Settings in the HP DeskJet Control Panel	3-6
Using the HP 1220C ToolBox.....	3-7

Using the Keypanel

Printer Buttons and LEDs

The HP 1220C Keypanel has three buttons and three lights.

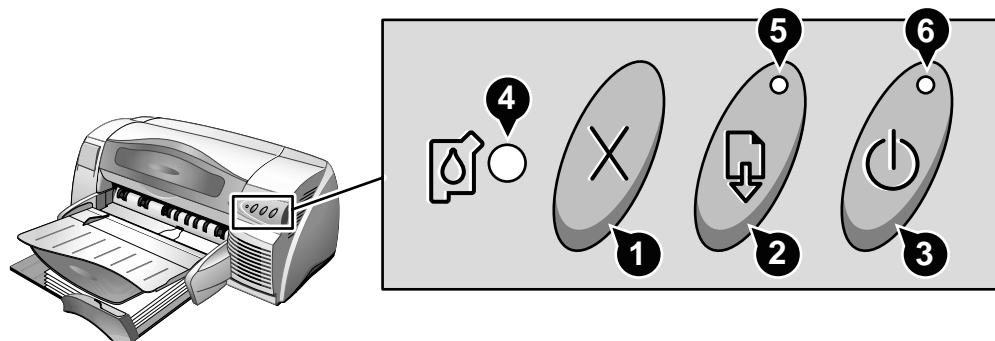

Figure 3.1 Printer Buttons and LEDs

- 1** Cancel Button—Cancels the current print job.
- 2** Resume Button—Blinks while waiting for a printed page to dry. Press it if you do not want to wait.
- 3** Power Button—Turns the power on and off.
- 4** Print Cartridge Light—Blinks when there is a problem with the print cartridges.
- 5** Resume Light—Blinks when there is a problem with the printer.
- 6** Power Light—Indicates whether the printer is on or off.

Printer Lights During Normal Printing

The following table describes how the printer lights appear during normal printing. For troubleshooting, see *Printer Lights Blink* on page 6-9.

Table 3.1 Printer Lights During Normal Printing

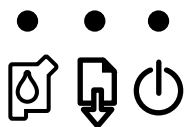
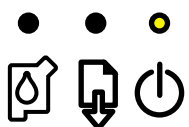
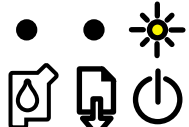
If...	Then...
 <p>All lights are off</p>	<p>The printer is off.</p>
 <p>The Power Light is on</p>	<p>The printer is ready to print. You can send a document to the printer.</p>
 <p>The Power Light is blinking</p>	<p>The printer is receiving data from the computer or is printing. Wait for the document to print.</p>

Using the Control Panel

Changing Default Print Settings

For Windows 95/98/NT 4.0 Users

To change default print settings for all documents, change the print settings in the Control Panel.

- 1 Click **Start**, select **Settings**, and then select **Printers**.
- 2 Right click the **HP DeskJet 1220C** icon and select **Properties**.
- 3 From the **Setup** tab, change desired settings.

For Windows 3.1 Users

- 1 Click the **Control Panel** icon in the Main window.
- 2 In the Control Panel window, double-click **Printers**.
- 3 Select the **HP DeskJet 1220C** and click **Setup**.
- 4 From the **Setup** tab, change desired settings.

For Macintosh Users

- 1 Choose **Print** from any application.
- 2 Choose **Printer Specific Options** from the pull down menu.
- 3 Make changes.
- 4 Click **Save Settings**, and then click **OK** to confirm.

Note

The print settings in a software program may override changes you make to print settings in the Control Panel.

Restoring Factory Defaults

For Windows 95/98/NT 4.0 Users

- 1 Click **Start**, select **Settings**, and then select **Printers**.

- 2 Right click the **HP DeskJet 1220C** icon and select **Properties**.
- 3 From the **Quick Sets** box, select **Factory Defaults**. The printer driver will restore default settings.

Using the HP DeskJet Control Panel for DOS

You have access to many printer features through application specific DOS printer drivers. However, some software manufacturers do not develop printer drivers for their DOS applications. Use the HP DeskJet Control Panel to change printer settings for printing from DOS applications.

Printer drivers are supplied by the manufacturers of DOS applications. The HP DeskJet 850 is the recommended printer driver. If it is not available, use the HP DeskJet 600 or 500 series.

Note

HP DeskJet Control Panel does not support many of the HP 1220C's special printing features. For more information, see the online help.

Installing the HP DeskJet Control Panel for DOS

Before you install the HP DeskJet Control Panel, make sure your printer is set up and turned on.

- 1 Insert the Starter CD into the CD-ROM drive.
- 2 At the DOS prompt `C:\>`, type the CD-ROM drive letter and change the directory to `\driver\win\disk4`. For example, type `D:` press ENTER, then type `cd\driver\win\disk4`, and press ENTER.
- 3 Type `INSTALL`, and press ENTER.
- 4 Follow the instructions on the screen to complete the installation.

Changing Print Settings in the HP DeskJet Control Panel

- 1 Open the DeskJet Control Panel by changing your directory to `C:\HP1220C`.
- 2 Type `DJCP`, and press ENTER.
- 3 Select printer settings that are not available from your DOS applications. Printer settings that are selected from a DOS application may override printer settings selected from the Control Panel.

Using the HP 1220C ToolBox

Access the HP 1220C ToolBox by double-clicking the Toolbox icon on the desktop or in the program group. The ToolBox contains “how-to” and troubleshooting instructions, and allows access to printer services and HP information. Some of these features are highlighted below.

Note

Toolbox is available only if you installed the printer driver through SETUP.EXE.

Table 3.2 HP 1220C ToolBox Features

Printer Services	How-to	Troubleshooting
Align print cartridges	Load print cartridges	Printer is not responding
Clean print cartridges	Clean print cartridges	Paper feed problem
Print a Self-Test page	Clear paper jam	Paper skew problem
Test printer communication	Change print settings	Blank page printed
	Cancel a print job	Poor print quality
	Print on various paper types and sizes	Unexpected results
	Use the printer on a network	Slow printing
		Printer lights blink
		Problems with network printing

Paper Selection and Paper Loading

Selecting Paper	4-2
Standard Paper	4-2
Custom Paper	4-2
Envelopes	4-2
Cards	4-3
Thick Cards	4-3
Labels	4-3
Transparencies and Slides	4-3
HP Special Paper	4-3
Loading Paper in Main (Bottom) Media Tray	4-4
Loading Paper in Alternative (Top) Media Feed	4-5
Loading Paper Through Rear Media Feed.....	4-6
Clearing Paper Jams.....	4-7
Tips for Avoiding Paper Jams	4-7

Selecting Paper

The HP 1220C printer prints on plain paper and many other types of media. Most plain paper used for photocopying yields good results. For more information see *Printer Description and Features* on page 1-4.

- Do not use media that is damaged, curled, or wrinkled. Do not use media with cutouts or perforations or paper that is heavily textured or embossed.
- Do not use multiple-part forms.
- Load only one media type at a time into any of the trays.
- Always load media print side down with the right edge aligned against the right edge of the tray.
- Do not load more than 150 sheets or 15 envelopes into the main (bottom) tray at one time. For the alternative (top) media feed, do not load more than 10 sheets of media or 3 envelopes. Load only one sheet of paper into the rear media feed tray.

Note

You do not need to remove media from the main tray when you use the alternative media feed. The printer checks for media loaded in the alternative media feed. If media is present, the printer picks the media from there without checking the main tray.

Standard Paper

You can load any standard paper size up to 13" x 50" (330 x 1016 mm) in the printer's main tray. Load the paper you normally use into the main tray. Load special paper into the alternative media feed.

Custom Paper

You can use custom or odd-sized paper with the HP 1220C printer, as long as the media dimensions are between the minimum (3.94" x 5.83", 100 x 148 mm) and maximum (13" x 50", 330 x 1016 mm) sizes.

Envelopes

You can print on envelopes using the main tray, the alternative media feed, or

the rear media feed.

Note

When you select a media type in Print Settings, the HP DeskJet 1220C automatically adjusts the cartridge-to-paper spacing. This reduces smears on thick media such as envelopes, cards, and postcards.

Cards

You can print on cards using the main tray, the alternative media feed, or the rear media feed.

Thick Cards

To print thick cards (0.5 mm, 0.02") or cards requiring a straight paper path, use the rear media feed slot at the back of the printer. Feed the cards into the printer one at a time.

Labels

Use Inkjet labels of sizes up to 330 mm x 1016 mm (13" x 50"), and ensure that they are in good condition.

Transparencies and Slides

Use transparency films that are designed to work with HP Inkjet printers, such as HP Premium Transparency Films.

HP Special Paper

To print high-quality images, use HP Premium Photo Papers and HP Premium Inkjet Papers, which are specifically designed to work with this printer, or use premium papers that are designed to work with Inkjet printers.

- HP Premium Photo Paper is designed to produce photographic-quality printouts.
- HP Premium Inkjet Paper is designed to enhance black or color printouts.

Note

If printing more than one page on transparency film or photo paper, the Resume Light blinks while the printer allows extra time for the ink to dry. Press the Resume Button if you do not want to wait for the ink to dry before printing the next page.

Loading Paper in Main (Bottom) Media Tray

The main media tray is designed to hold the media type you use most often. It can hold up to 150 sheets of plain paper or 30 transparencies.

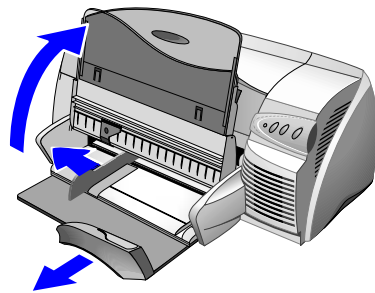

1 Lift the Output Tray and extend the paper width and length adjusters to their outermost positions.

2 Insert up to a 3/4" (19 mm) stack or 150 sheets of paper, along the right side of the main tray, **print side down**, until it stops.

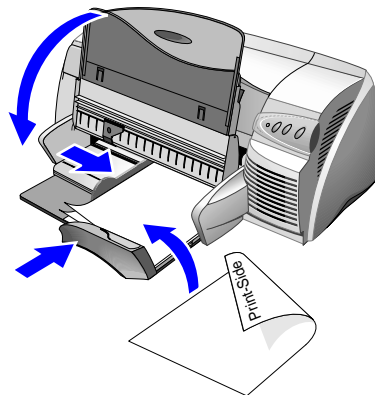

3 Slide the width and length adjusters in to meet the edges of the paper.

4 Select **Print Settings** and click **Setup**. Change the print settings to match the media size, type, source, and orientation and click **OK**.

Figure 4.1 Loading Paper in Main (Bottom) Media Tray

Loading Paper in Alternative (Top) Media Feed

The alternative media feed is designed to hold the various media types and sizes used for occasional printing. It can hold up to 10 sheets of plain paper or 3 transparencies.

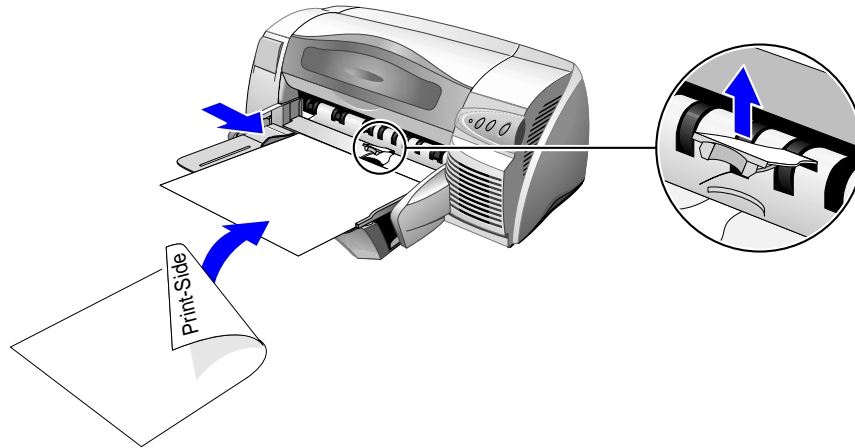

Figure 4.2 Loading Paper in Alternative (Top) Media Feed

Note

You do not need to remove paper from the main tray when you use the alternative media feed. The printer will check for paper in the alternative media feed. If paper is detected, the printer will pick paper from there and not from the main tray.

- 1 Extend the Output Tray and slide the paper width adjuster to the outermost position.
- 2 Lift the small flap on the Output Tray and insert a maximum of 10 sheets of media along the right side of the alternative media feed, **print side down**, until stopped.
- 3 Slide the paper width adjuster in until it stops at the edges of the media.
- 4 Select **Print Settings** and then click **Setup**. Change the print settings to match the paper size, type, source, and orientation, and then click **OK**.

Loading Paper Through Rear Media Feed

The rear media feed is designed for printing on thicker paper like card stock and photo paper without bending or warping. This media feed is specially designed to give you a straight paper path.

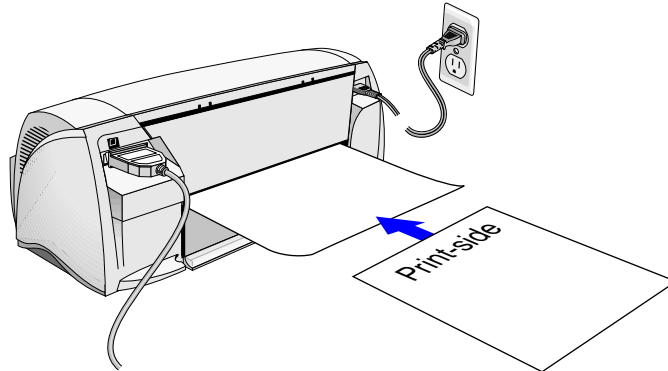

Figure 4.3 Loading Paper Through Rear Media Feed

Note

To print thick cards or cards requiring a straight paper path, use only the rear media feed. Feed the cards into the printer one at a time.

- 1 In HP's print settings dialog box, click **Setup** and select **Manual Feed** in the Paper Source box. Change other print settings, if necessary, and click **OK**.
- 2 When the Resume Light blinks, insert media, **print side up**, into the rear media feed, making sure that the edge of the sheet is aligned with the alignment mark at the side of the slot. Press the Resume Button to continue printing.

Clearing Paper Jams

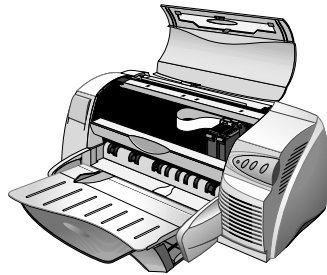

- 1 To clear the printer of any jammed paper, open the Access Door and pull the paper towards you.

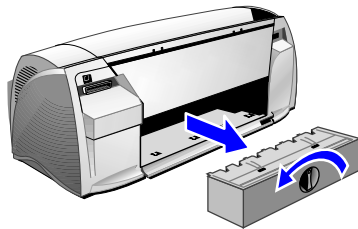

- 2 If you cannot reach the jammed paper, turn the knob at the back of the printer, remove the Cleanout Trough, pull out the jammed paper, and replace the Cleanout Trough.

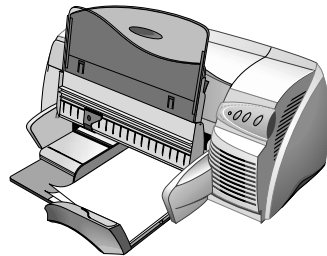

- 3 If you still cannot reach the paper, lift up the Output Tray, and remove the jammed paper from the main paper tray.

Figure 4.4 Clearing Paper Jams

Tips for Avoiding Paper Jams

- Make sure nothing is blocking the paper path.
- Do not overload the alternative media feed. The alternative media feed holds up to 10 sheets of plain paper or other media measuring the same thickness. The main media tray holds up to 150 sheets of plain paper.
- Load media properly.
- Do not use media that is curled or crumpled.
- Always use paper that conforms to the media specifications.

Printer Maintenance

Cleaning the Printer.....	5-2
Using and Caring for Print Cartridges.....	5-3
Print Cartridge Icons.....	5-3
Cleaning the Print Cartridges	5-4
Pen Recovery Diagnostic Test	5-4
Cleaning the Electrical Contacts.....	5-6
Tips for Maintaining the Print Cartridges	5-6
Print Cartridge Life.....	5-7
Changing the Print Cartridges.....	5-7
Aligning the Print Cartridges.....	5-9
Calibration Diagnostic Test	5-9

Cleaning the Printer

The printer does not require scheduled maintenance. Periodic cleaning, however, enhances the look of the printer and keeps it in peak condition. Cleaning may also make it easier to diagnose problems.

Clean the exterior with a soft cloth moistened with mild detergent and water.

WARNING!

Turn the printer off and unplug the power cable before cleaning the printer.

Caution





Use only water and mild detergent to clean the printer, other cleaners or alcohol may damage the printer.

Using and Caring for Print Cartridges

Print Cartridge Icons

When you open the Access Door, the yellow arrow on the print cartridge cradle aligns to one of the icons near the back of the printer. If the Print Cartridge Light flashes, open the Access Door and follow the instructions below.

Table 5.1 Print Cartridge Icons

If the arrow points to...	It means...	To solve the problem...
	The color print cartridge is either: <ul style="list-style-type: none">• missing• improperly installed• the wrong print cartridge for the printer• defective	<ol style="list-style-type: none">1 Insert print cartridge if there is none or reinsert print cartridge if there is one.2 Verify the color cartridge is an HP C6578 Series cartridge.3 If the problem persists, replace the cartridge.
	The black print cartridge is either: <ul style="list-style-type: none">• missing• improperly installed• the wrong print cartridge for the printer• defective	<ol style="list-style-type: none">1 Insert print cartridge if there is none or reinsert print cartridge if there is one.2 Verify the black cartridge is an HP 51645 Series cartridge.3 If the problem persists, replace the cartridge.
	Color print cartridge is running low on ink.	Consider replacing the color cartridge with an HP C6578 Series cartridge.
	Black print cartridge is running low on ink.	Consider replacing the black cartridge with an HP 51645 Series cartridge.
	Print cartridges are OK!	No problems.

Cleaning the Print Cartridges

Clean the ink nozzles of the print cartridge if the characters printed are incomplete, or if dots or lines are missing from the printouts. This is a symptom of clogged ink nozzles resulting from prolonged exposure to air.

Note

Do not clean the print cartridges unnecessarily because this wastes ink and shortens the life of the print cartridges.

- 1 Open the ToolBox by double-clicking the HP 1220C icon on your desktop or click **Start**, select **Programs**, followed by “**HP 1220C Series**”, followed by HP 1220C ToolBox.
- 2 Choose **Printer Services** and select **Clean Print Cartridges**.
- 3 Follow the instructions on the screen to clean the cartridges.

Pen Recovery Diagnostic Test

If printouts have incomplete text or graphics that are not corrected by cleaning the print cartridges, use the Pen Recovery Diagnostic Test. The Pen Recovery Diagnostic Test is a three level cleaning procedure that attempts to clean blocked print cartridge nozzles.

Level One

Level One performs a light print cartridge cleaning.

- 1 Hold down the Power Button while pressing the Cancel Button twice.
- 2 Release the Power Button.
- 3 Run the Nozzle Pattern Diagnostic Test (see page 6-62). Look for gaps in the Nozzle Pattern test. If no gaps are present, the print cartridge has recovered. If gaps appear, run Level Two of the Pen Recovery test.

Level Two

Level Two performs an intermediate cleaning routine.

Note

Do not use this Pen Recovery test unnecessarily. This test shortens the life of the print cartridges.

- 1 Hold down the Power Button while pressing the Cancel Button twice and the Resume Button once.

- 2 Release the Power Button.
- 3 Run the Print Cartridge Nozzle Test. Look for gaps in the Nozzle Pattern test. If no gaps are present, the print cartridge is recovered. If gaps appear, run Level Three of the Pen Recovery test.

Level Three

Level Three performs an intensive cleaning routine that takes about 2 minutes to complete.

- 1 Hold down the Power Button while pressing the Cancel Button twice and the Resume Button twice.
- 2 Release the Power Button.
- 3 Run the Print Cartridge Nozzle Test. Look for gaps in the Nozzle Pattern test. If no gaps are present, the print cartridge is recovered. If gaps appear, replace the print cartridge.

Note

Use this test as the last resort for recovering clogged print cartridge; it consumes a considerable amount of ink.

Cleaning the Electrical Contacts

Poor contact between the print cartridges and cartridge cradles may also affect the quality of the printout. When this occurs, try cleaning the print cartridges and cartridge cradles.

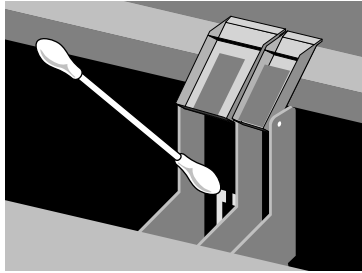

- 1 Remove the print cartridge from the printer.
- 2 Clean the electrical contacts on the print cartridge cradle with a dry cotton swab.
- 3 Clean the electrical contacts on the print cartridge with a dry lint free cloth. To prevent the electrical contacts from damage, you should wipe the contacts only once. Do not wipe the ink nozzles on the print cartridge.
- 4 Re-install the print cartridge.

Figure 5.1 Cleaning the Electrical Contacts

Tips for Maintaining the Print Cartridges

- Keep the print cartridges sealed in the original packaging until you are ready to use them.
- Keep opened print cartridges in the printer or sealed in a plastic bag.
- Store print cartridges at room temperature.
- Use a “first-in first-out” inventory process to avoid having expired print cartridges in stock.
- Power off the printer by pressing the Power Button instead of by unplugging the power cord. Powering off with the Power Button returns the Carriage to the Service Station. The Service Station caps the print cartridge nozzles to prevent them from drying.

Print Cartridge Life

Print cartridge life for both black and color print cartridges is 18 months.

Note

The color print cartridge life specification is based on an 8" x 10" (203.2 mm x 254 mm) printable area with a 15% printing density.

Identifying Print Cartridge Expiration Dates

Using expired print cartridges may cause print quality problems. Several important dates concerning print cartridge life are listed below.

- **Install Before Date**—Located on the print cartridge carton. This date is printed on the side of the box for color print cartridges and on the bottom of the box for black print cartridges. The cartridge has a 24 month shelf-life.
- **Manufacture Date**—Since the cartridge has a 24 month shelf-life, the manufacture date is exactly two years before the Install Before Date.
- **End of Warranty Date**—A cartridge is under warranty for 90 days of use if it is installed prior to the Install Before date. The End of Warranty date (YYYY/MM/DD) is marked on the cartridge itself and is the last day that the cartridge is under warranty. The End of Warranty Date = Manufacture Date + Shelf-life + 90 days.

The printer will allow a print cartridge to be used in the printer for two and a half years (130 weeks) after the date the cartridge was installed. This is the expiration date recorded in the ToolBox (Expiration Date = Date Cartridge Installed + 130 weeks). In the event that a cartridge is installed (and accepted) in the printer after the Install Before date has expired, the expiration date recorded in the ToolBox will be the following: Expiration Date = Install Before date + 130 weeks.

Changing the Print Cartridges

Both print cartridges are installed in the same manner.

Note

When you install a new cartridge, the printer automatically aligns the cartridges by printing a page. Make sure your printer has a sheet of standard paper available to perform the alignment. If you replace a cartridge during a print job, alignment occurs after the print job is finished.

- 1 Power on the printer and open the Access Door. The Carriage will move to the center of the printer.

- 2 Flip up the print cartridge latch, grasp the top of the old print cartridge, and pull it up and out of its cradle.

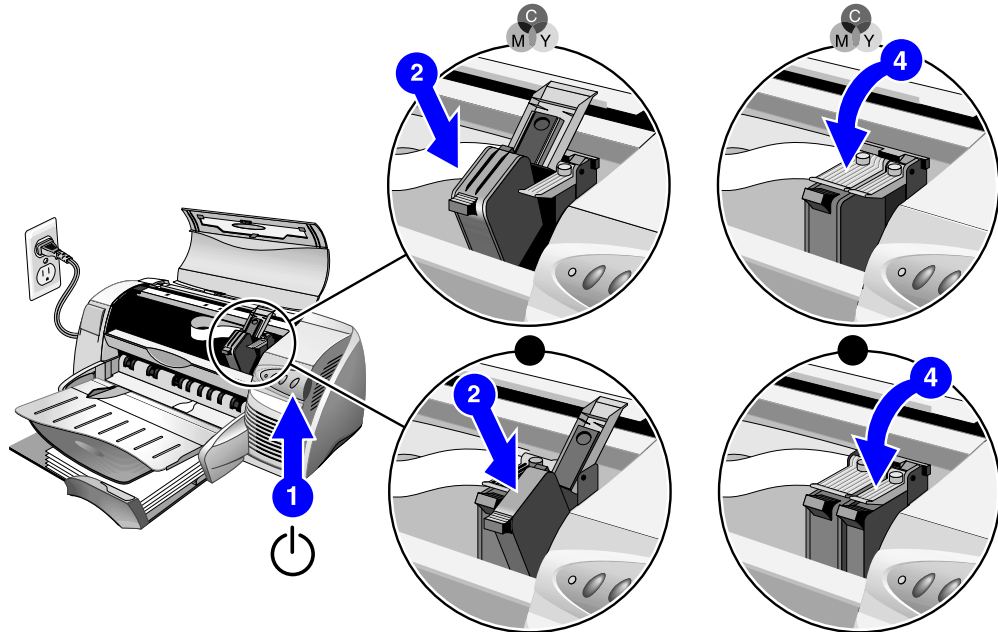

Figure 5.2 Changing the Print Cartridges

- 3 Remove the new print cartridge from its package, and without touching the ink nozzles or the contacts, gently remove the tape covering the ink nozzles.

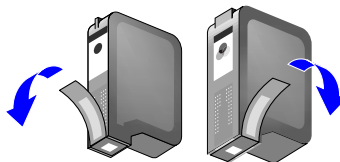

Figure 5.3 Removing Tape from Ink Nozzles

- 4 Push the new cartridge down firmly into its cradle slot, and close the print cartridge latch.
- 5 Close the Access Door.

Note

If you did not install a recommended print cartridge, or the print cartridge is not properly installed, the Carriage will return to the loading position, and the Print Cartridge Light will continue to blink.

Aligning the Print Cartridges

The printer automatically aligns the print cartridges whenever you replace one. If the printout looks like the cartridges are misaligned, you can align them manually.

- 1 Open the ToolBox by double-clicking the HP 1220C icon on your desktop or click **Start**, select **Programs**, followed by “**HP 1220C Series**“, followed by HP 1220C ToolBox.
- 2 Select **Printer Services** and choose **Align Print Cartridges**.
- 3 Follow the instructions on the screen to align the cartridges.

If the cartridges are still not aligned, conduct the Calibration Diagnostic Test.

Calibration Diagnostic Test

This test calibrates the print cartridges by aligning the cartridges, as well as optimizing the turn-on energy for the color print cartridge.

- 1 Hold down the Power Button while pressing the Resume Button three times.
- 2 Release the Power Button. The printer prints a Calibration Diagnostic test page. A green check mark to the left of each test, indicates that calibration was successful.

See *Calibration Diagnostic Test* on page 6-64 for more information.

Troubleshooting

Troubleshooting Strategy	6-2
Software Troubleshooting	6-3
Problems with a Network Printer	6-4
Printer is not Responding	6-6
Printer Lights Blink	6-9
Paper Feed Problems	6-10
Paper Skew	6-13
A Blank Page is Printed	6-14
Poor Print Quality	6-16
Unexpected Results	6-21
Hardware Troubleshooting	6-27
Troubleshooting Tools	6-27
Diagnostic Tools	6-27
The HP DeskJet 1220C Quick Checkup	6-28
Troubleshooting Hardware Problems	6-29
Troubleshooting Power On Problems	6-30
Troubleshooting Printer Initialization Problems	6-33
Troubleshooting Using LEDs	6-36
Troubleshooting Paper Feed Problems	6-47
Troubleshooting the Self-Test	6-49
Troubleshooting Paper Eject Problems	6-55
Troubleshooting Unusual Noises	6-57
Diagnostic Tools	6-59
Self-Test	6-59
Sample Page	6-60
Single Diagnostic Test	6-61
Nozzle Pattern Diagnostic Test	6-62
Pen Recovery Diagnostic Test	6-63
Calibration Diagnostic Test	6-64
Extended Diagnostic Test	6-66
Dot Count Diagnostic Test	6-67
Pen ID Diagnostic Test	6-68
Infinite Hs Diagnostic Test	6-69
Page Alignment Diagnostic Test	6-70
DeskJet 1220C Software Diagnostic Test Program	6-72

Troubleshooting Strategy

This chapter is divided into two sections: *Software Troubleshooting* and *Hardware Troubleshooting*.

Often, customers have printer problems that are the result of improper configuration, operation, or maintenance of the printer. Many of these problems can be diagnosed and remedied over the phone. *Software Troubleshooting* helps you ask customers the proper questions over the telephone and helps determine when a customer needs to return a printer for repair. To begin troubleshooting over the phone, see *Software Troubleshooting* on page 6-3.

Hardware Troubleshooting requires the printer to be present to confirm or further diagnose the problem before repair. Follow the steps outlined in *Hardware Troubleshooting* on page 6-27 to efficiently and effectively diagnose hardware problems.

Note

Both sections contain decision trees to help you troubleshoot printer problems. Grayed boxes in the decision trees indicate that further information is provided on the pages following the decision tree.

Software Troubleshooting

Typically, customers will call and tell you that their printer exhibits one of the following symptoms. Use this table to begin troubleshooting over the phone with a customer.

Table 6.1 Software Troubleshooting

Symptom	Go to
Problems with a network printer?	page 6-4
Printer is not responding?	page 6-6
Printer lights blink?	page 6-9
Paper feed problem?	page 6-10
Paper skew problem?	page 6-13
A blank page is printed?	page 6-14
Poor print quality?	page 6-16
Unexpected printout results?	page 6-21
Slow printing?	page 6-25

Problems with a Network Printer

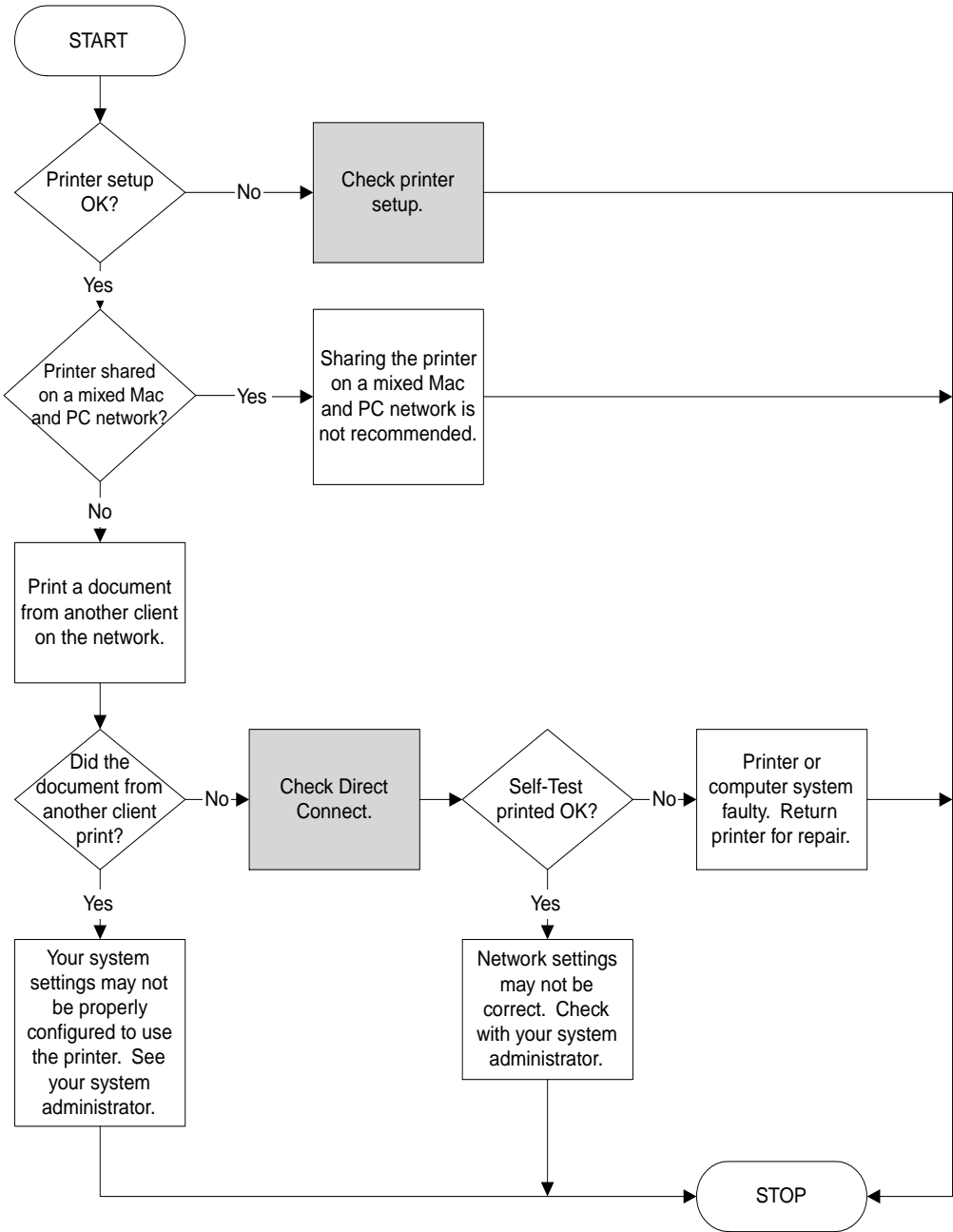

Tree 6.1 Problems with a Network Printer

Printer Setup

- 1 Make sure the printer is on and the Access Door is closed.
- 2 Make sure the Cleanout Trough is in the lock position.
- 3 Check that the cartridges are installed properly and paper is properly loaded in the printer.
- 4 Make sure the network and printer cable connections are firmly in place.
- 5 If the Resume Light is blinking, press it and wait a few seconds for printing to start.
- 6 If printing does not resume, open the Access Door and check for a paper jam.

Direct Connect

- 1 Connect the printer to a PC that is running Windows.
- 2 Install the printer software if it is not previously installed on this PC.
- 3 Double-click the Toolbox icon on the Desktop or in the Printer Group.
- 4 Select **Printer Services** and click **Print a Self-Test Page**.

Printer is not Responding

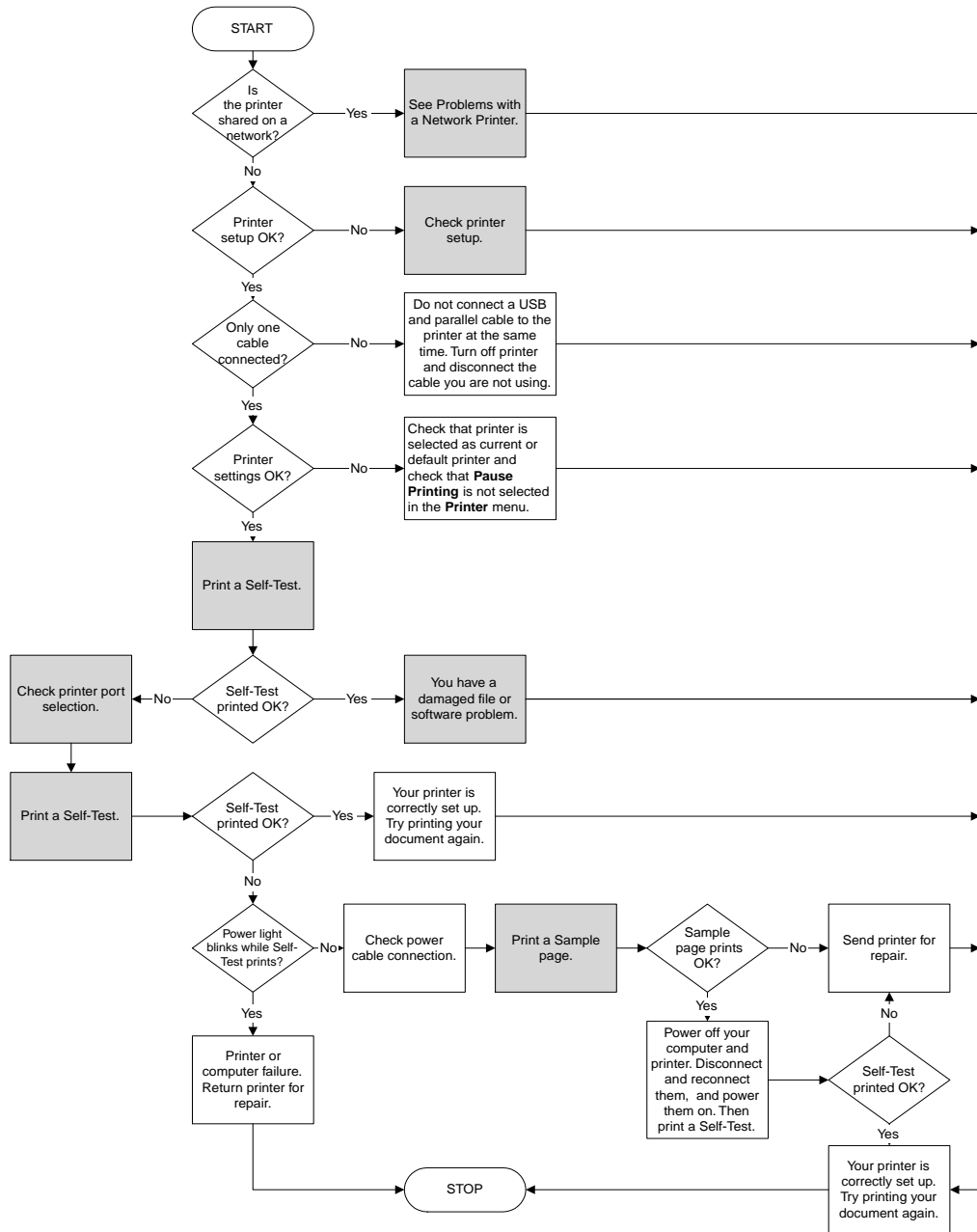

Tree 6.2 Printer is not Responding

Problems with a Network Printer

See *Problems with a Network Printer* on page 6-4.

Printer Setup

- 1 Make sure the printer is on and the Access Door is closed.
- 2 Make sure the Cleanout Trough is in the lock position.
- 3 Check that the cartridges are installed properly and paper is properly loaded in the printer.
- 4 Make sure the network and printer cable connections are firmly in place.
- 5 If the Resume Light is blinking, press it and wait a few seconds for printing to start.
- 6 If printing does not resume, open the Access Door and check for a paper jam.

Print a Self-Test

- 1 Open the ToolBox by double-clicking the HP 1220C icon on your desktop or click **Start**, select **Programs**, followed by “**HP 1220C Series**“, followed by HP 1220C ToolBox.
- 2 Select **Printer Services** and click **Print a Self-Test Page**.

See page 6-59 for an example of a Self-Test page.

Printer Port Selection

Ensure that the right port (USB, LPTx) is selected and that the printer is connected directly to your computer. If your printer is connected to a switch box, make sure that you have selected the correct switch.

Print a Sample Page

- 1 Turn off the printer, and then turn it on again by pressing the Power Button.
- 2 Press the Resume Button and release it when the Resume Light turns off. Your printer prints a Sample page.

See page 6-59 for an example of a Sample page.

Damaged File or Software Problem

See below for possible causes.

- If the printer previously worked with the same software program, try printing another file using the software. If you managed to print this file, the file you were previously trying to print might be damaged. If you have a backup copy of the file, try printing it.
- Try printing from another software program. If you can print from another program, your printer setup is correct.
- If none of the above solutions worked, this problem is likely caused by your software program's inability to properly interpret print settings. Check the Release Notes for known software conflicts. Otherwise, check your software program manual, or call the software manufacturer to get more specific help for this problem.

Printer Lights Blink

Table 6.2 Printer Lights Blink

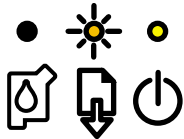
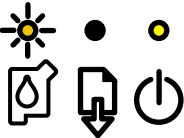
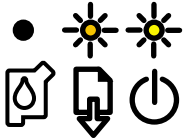
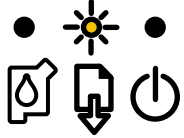
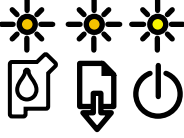
Printer Lights	Possible Causes
 <p>Power Light On and Resume Light blinks</p>	<p>There is an I/O (Input/Output) Stall.</p> <ul style="list-style-type: none"> • The printer is out of paper. • Paper needs to be ejected. • There is a media size or type mismatch. • The printer is no longer receiving data. • The printer is waiting for the page to dry before printing the next page. • Manual Duplex is waiting for user's action.
 <p>Power Light On and Print Cartridge Light blinks</p>	<ul style="list-style-type: none"> • Incorrect installation. • Print cartridge is damaged or not usable. • Low or out of ink. • Wrong type of print cartridge.
 <p>Power and Resume Lights blink (synchronous)</p>	<p>There is a Carriage Stall. Power off the printer and open the Access Door. Remove any packing materials or excess paper from the printer. When there are no obstructions, power the printer off and then on again.</p>
 <p>Resume Light blinks</p>	<p>There is a paper jam or paper motor stall. Clear paper jam.</p>
 <p>All Lights blink</p>	<p>This is an error trap code. Turn the printer off, then on again. If all the lights still blink, the problem is likely caused by a failure in the printer. Send printer for repair.</p>

The Power Light blinks when printing. This is normal.
 The Power Light blinks 2-on, 1-off when a print job is being cancelled.

Paper Feed Problems

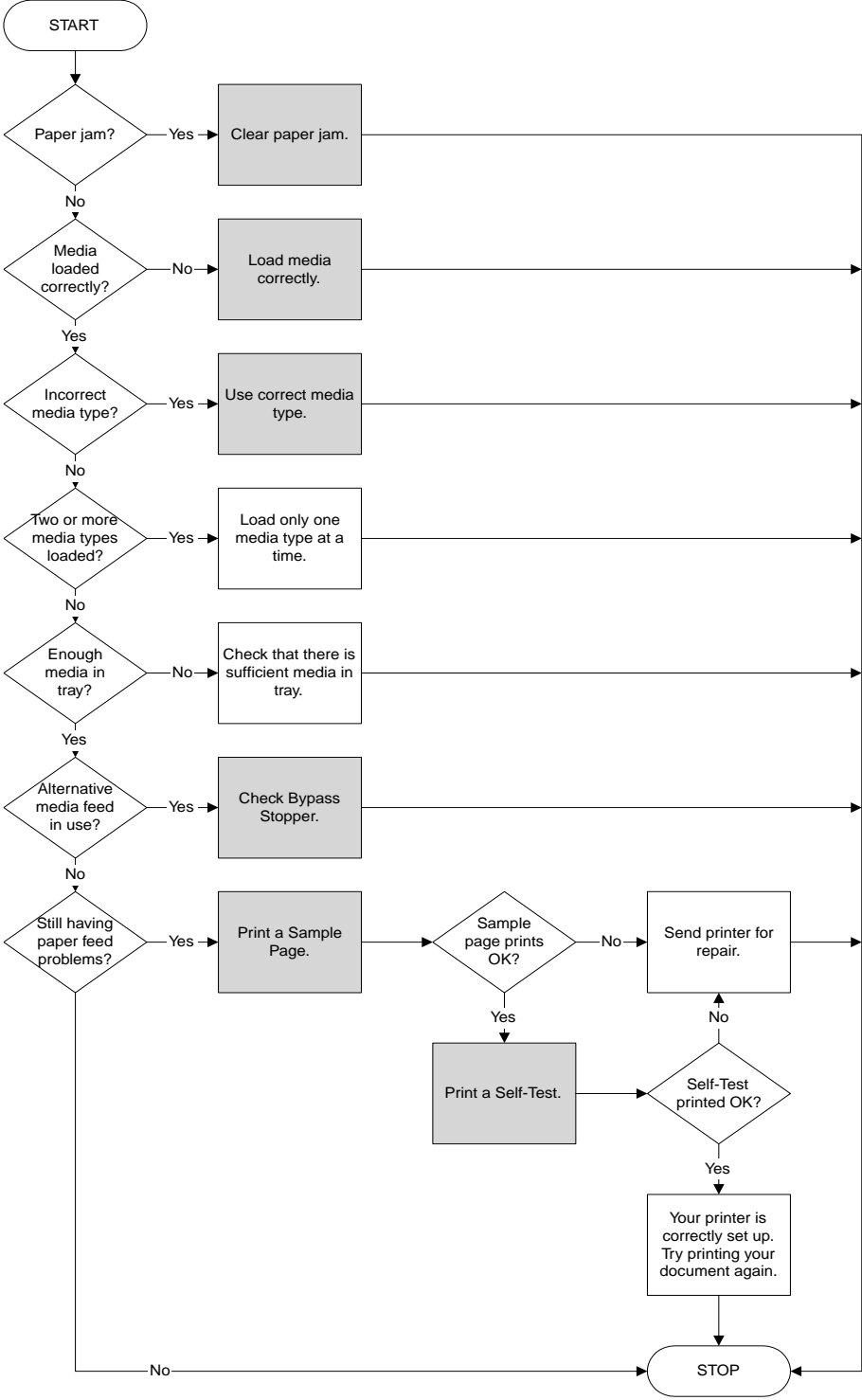

Tree 6.3 Paper Feed Problems

Clear Paper Jam

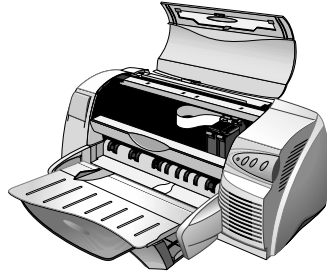

- 1 To clear the printer of any jammed paper, open the Access Door and pull the paper towards you.

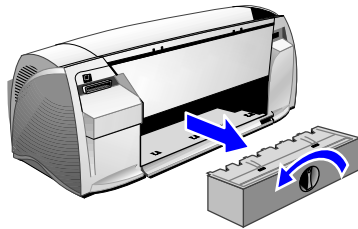

- 2 If you cannot reach the jammed paper, turn the knob at the back of the printer, remove the Cleanout Trough, pull out the jammed paper, and replace the Cleanout Trough.

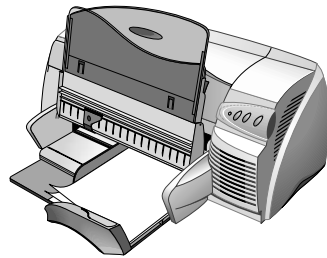

- 3 If you still cannot reach the paper, lift up the Output Tray, and remove the jammed paper from the main paper tray.

Figure 6.1 Clear Paper Jam

Load Media Correctly

Make sure the paper width and length adjusters fit snugly against the left and bottom edges of the paper stack.

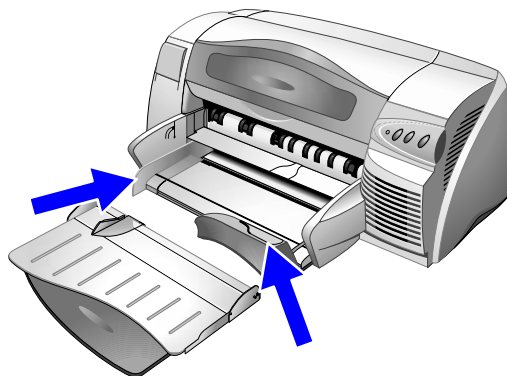

Figure 6.2 Load Media Correctly

Use Correct Media Type

Some paper types are not suitable for use with your HP DeskJet printer, see *Selecting Paper* on page 4-2.

Bypass Stopper

If you are using the alternative top media feed, check that the Bypass Stopper is lifted and that the paper slides in underneath the latch.

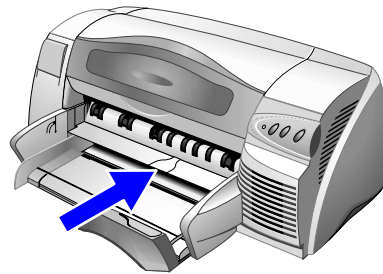

Figure 6.3 Bypass Stopper

Print a Sample Page

- 1 Turn off the printer, and then turn it on again by pressing the Power Button.
- 2 Press the Resume Button and release it when the Resume Light turns off.
- 3 The printer prints a Sample page.

See page 6-59 for an example of a Sample page.

Print a Self-Test

- 1 Open the ToolBox by double-clicking the HP 1220C icon on your desktop or click **Start**, select **Programs**, followed by “**HP 1220C Series**”, followed by HP 1220C ToolBox.
- 2 Select **Printer Services** and click **Print a Self-Test Page**.

See page 6-59 for an example of a Self-Test page.

Paper Skew

If paper is twisting as it feeds or margins appear crooked check the following:

Media Loaded Correctly?

Make sure the paper width and length adjusters fit snugly against the left and bottom edges of the paper stack.

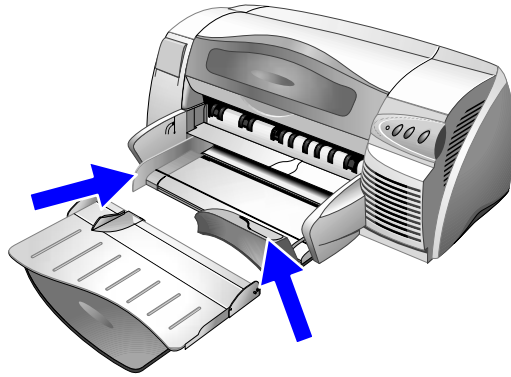

Figure 6.4 Load Media Correctly

Printing from Alternative Top Media Feed?

If you are trying to print from the alternative media feed, try printing from the main media tray. Use the paper guides to help eliminate the skew problem.

Nothing Works?

If none of these solutions work, this problem is likely caused by a failure in the printer or computer system. Send printer for repair.

A Blank Page is Printed

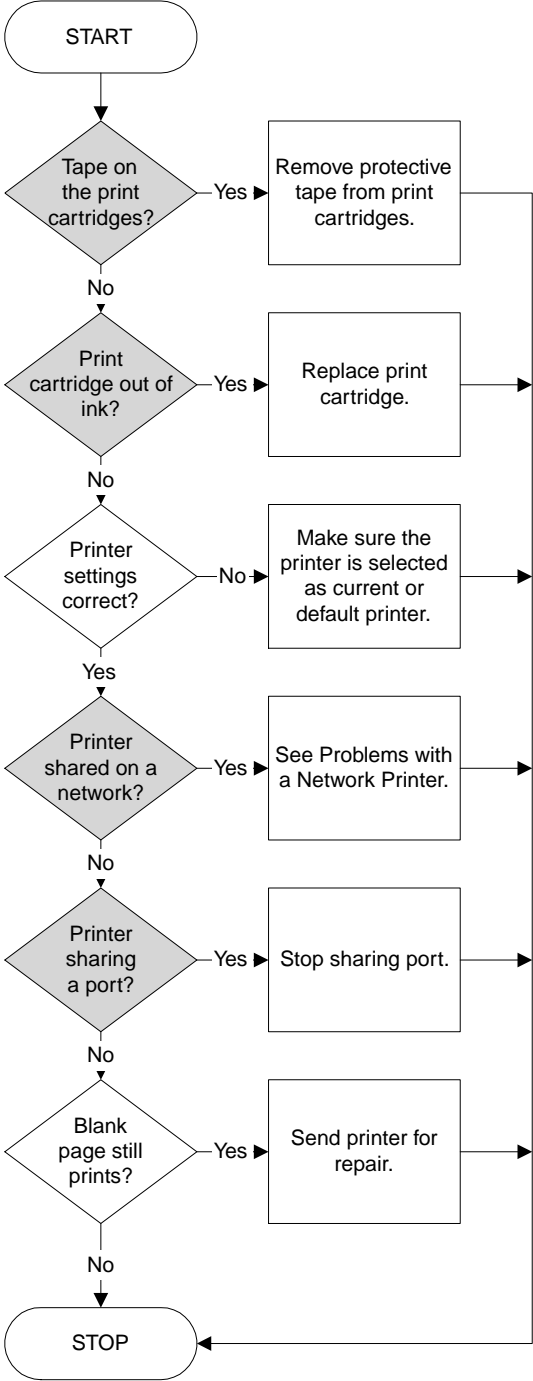

Tree 6.4 A Blank Page is Printed

Protective Tape on the Print Cartridge?

Each new print cartridge is packaged with protective plastic tape covering the ink nozzles. Check each print cartridge and remove tape if necessary.

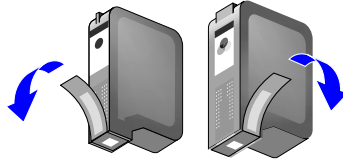

Figure 6.5 Removing Protective Tape from Ink Nozzles

Out of Ink?

If you are printing black text and a blank page prints, your black print cartridge may be empty. Replace the black print cartridge. To change the black cartridge, see *Changing the Print Cartridges* on page 5-7.

Note

Open the Access Door when you suspect a print cartridge problem. Inside, you will see icons showing cartridge problems. If there is a problem, the yellow arrow on the cartridge cradle points to the icon that indicates the problem.

Printer Shared on a Network?

See *Problems with a Network Printer* on page 6-4.

Conflicts with Port Sharing Devices?

A probable cause for this problem is a conflict between the printer and other port sharing devices such as zip drives and other printers. Do not share the port with another device. Disable bi-directional communication and try to print again:





- 1 Open the Toolbox. Select **Printer Status** and click **Preferences**.
- 2 Uncheck **Enable Bi-directional Communication**.

Poor Print Quality

Note

Open the top cover when you suspect a print cartridge problem. The inside top case has icons on it showing cartridge problems. If there is a problem, the yellow arrow on the cartridge cradle points to the icon that indicates the problem.

Table 6.3 Poor Print Quality

Symptom	Go to
 Printout is faded or colors are dull?	page 6-17
 Colors are bleeding into each other?	page 6-18
 Ink is smearing onto white (blank) areas?	page 6-18
 Ink is not filling the text or graphics completely?	page 6-19
 Text is jagged (not smooth) at the edges?	page 6-20



Faded or Dull Colors

Possible causes:

EconoFast Print Mode Selected?

The EconoFast option uses less ink and prints at a faster rate; use it for printing drafts. To achieve better colored printouts, select Normal or Best Quality in the printer driver.

Paper Type Print Settings Wrong?

When printing on transparencies or other special media, select the corresponding media type in HP's print settings dialog box.

Incorrect Media Type?

Some paper types are not suitable for use with your HP DeskJet printer, see *Selecting Paper* on page 4-2.

Print Cartridge Low on Ink or Clogged?

Whenever print quality deteriorates, it is a good idea to perform the cleaning procedure and then a Self-Test.

To clean the print cartridges:

- 1 Open the ToolBox by double-clicking the HP 1220C icon on your desktop or click **Start**, select **Programs**, followed by "**HP 1220C Series**", followed by HP 1220C ToolBox.
- 2 Choose **Printer Services** and select **Clean Print Cartridges**.
- 3 Follow the instructions on the screen to clean the cartridges.

To print a Self-Test:

- 1 Open the ToolBox by double-clicking the HP 1220C icon on your desktop or click **Start**, select **Programs**, followed by "**HP 1220C Series**", followed by HP 1220C ToolBox.
- 2 Select **Printer Services** and click **Print a Self-Test Page**.

Check that all the lines are connected and printed properly on the Self-Test page. If the lines are broken, your print cartridge is probably out of ink. Replace your print cartridge with a new one. However, if you have recently replaced your cartridge, your cartridge is probably bad.

Nothing Works?

If none of these solutions work, this problem is likely caused by a failure in the printer or computer system. Send printer for repair.



Bleeding Colors

Possible causes:

Print Setting Uses Too Much Ink?

Some Paper Type settings (such as Transparency) and Print Quality settings (such as Best) require more ink than others. Choose different print settings in HP's print settings dialog box. Also, make sure that you have selected the correct media type in HP's print settings dialog box.

Incorrect Media Type?

Some media types are not suitable for use with your HP DeskJet printer, see *Selecting Paper* on page 4-2.

Refilled Print Cartridges?

Refilling print cartridges is not recommended.

Caution

The ink in the print cartridges has been carefully formulated by Hewlett-Packard to ensure superior print quality and compatibility with your printer. Damage to the printer or the print cartridge resulting from modifying or refilling the print cartridge is not the responsibility of HP.

Nothing Works?

If none of these solutions work, this problem is likely caused by a failure in the printer or computer system. Send printer for repair.



Ink Smear

Possible causes:

Insufficient Drying Time?

When printing documents that use a lot of ink, you must allow the document more time to dry before handling it. This is especially true for transparencies. Check immediately after printing whether smearing occurs in the printout. You can set dry time using the Printer control panel.

Paper Type Causing Smearing?

Some types of paper don't accept ink well, which causes the ink to dry more slowly and results in smearing.

Page is Wrinkling with Too Much Ink?

Color documents with rich, blended colors can use excess ink, which wrinkles the page during printing and causes smearing. Try using the Normal or Fast Print Quality setting to reduce ink, or use HP Premium Paper designed for ink-jet printing of vivid color documents.

Excess Ink Crusted on Print Cartridge?

An ink buildup problem can be solved by performing the cleaning procedure:

- 1 Open the ToolBox by double-clicking the HP 1220C icon on your desktop or click **Start**, select **Programs**, followed by “**HP 1220C Series**“, followed by HP 1220C ToolBox.
- 2 Choose **Printer Services** and select **Clean Print Cartridges**.
- 3 Follow the instructions on the screen to clean the cartridges.

Nothing Works?

If none of these solutions work, this problem is likely caused by a failure in the printer or computer system. Send printer for repair.



Incomplete Text

Possible causes:

Print Cartridges Need Cleaning?

Whenever print quality noticeably decreases it is a good idea to perform the cleaning procedure:

- 1 Open the ToolBox by double-clicking the HP 1220C icon on your desktop or click **Start**, select **Programs**, followed by “**HP 1220C Series**“, followed by HP 1220C ToolBox.
- 2 Choose **Printer Services** and select **Clean Print Cartridges**.
- 3 Follow the instructions on the screen to clean the cartridges.

Print Cartridges have Poor Contact?

Try removing and then reinstalling the print cartridges, making sure to snap them firmly into place.

Print Cartridge Out of Ink?

If cleaning the print cartridges doesn't help, your print cartridge may be out of ink. Replace the empty print cartridge. See *Changing the Print Cartridges* on page 5-7.

Incorrect Media Type?

Some media types are not suitable for use with your HP DeskJet printer, see *Selecting Paper* on page 4-2.

Print Quality Settings Wrong?

Try printing using Best mode.

Nothing Works?

If none of these solutions work, this problem is likely caused by a failure in the printer or computer system. Send printer for repair.



Jagged Text

Possible causes:

Wrong Type of Font Chosen?

Some software programs offer custom fonts that have jagged edges when enlarged or printed. By using TrueType fonts you can ensure that the printer is able to print smooth fonts. When selecting a font, look for the TrueType icon.

Printing Bitmap Text?

If you are trying to print a bitmap image of text, it may have jagged edges when skewed, enlarged or printed. By using TrueType fonts you can ensure that the printer is able to print smooth fonts. When selecting a font, look for the TrueType icon.

Incorrect Media Type?



Paper that is heavily textured or does not accept ink well can cause graphics and text to print poorly.

Nothing Works?

If none of these solutions work, this problem is likely caused by a failure in the printer or computer system. Send printer for repair.

Unexpected Results

Table 6.4 Unexpected Results

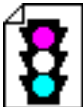
Symptom	Go to
 Text or graphics are cut off at the edges of the page?	page 6-22
 Meaningless characters printed?	page 6-22
 Wrong fonts printed?	page 6-24
 Colors are different than they should be?	page 6-24

If none of the above suggestions describe your problem, see the Readme file for a list of known problems.



Text or Graphics Cut Off

Possible causes:

Wrong Page Orientation Setting?

The page orientation selected might not be correct for the document you are printing.

Wrong Margin Settings?

Make sure margin settings for the document do not exceed the printable area of your printer.

Content Doesn't Fit on Page?

Content that is cut off might be outside the printable area. Or, the size of the document you are printing is larger than the paper size in the main tray.

Media Loaded Correctly?

Make sure the paper width and length adjusters fit snugly against the left and bottom edges of the paper stack.

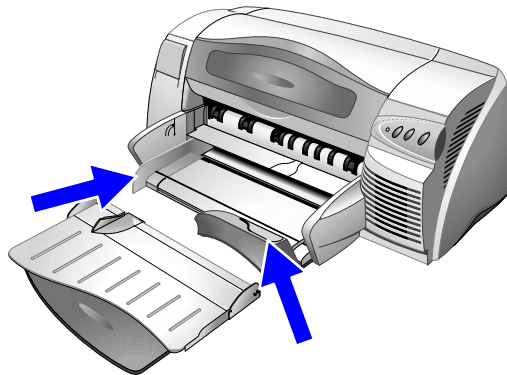
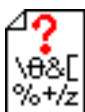

Figure 6.6 Load Media Correctly

Also, make sure that the correct paper orientation is selected. For instructions on how to load paper, see page 4-4.

Nothing works?

If none of these solutions work, this problem is likely caused by a failure in the printer or computer system. Send printer for repair.



Meaningless Characters Printed

Possible causes:

Cable Connection is Poor?

A common cause for nonsense characters is a poor cable connection between the printer and computer.

To check the printer cable:

- 1 Disconnect the cable from the printer and power on your printer.
- 2 If your printer powers on, try connecting your printer to your computer using a different cable.
- 3 If this does not work, reboot the system. Or, try connecting your printer to another system.

System Needs to be Restarted?

Turn off the printer and computer for a few seconds, turn them both back on, and then try printing again.

Wrong Printer Selected?

Check to make sure your HP DeskJet printer is selected as the current or default printer.

- 1 In the **Printers** folder, click **HP DeskJet icon**.
- 2 From the **File** menu, click **Set As Default**.

Document File is Damaged?

This happens occasionally. If you can print other documents from the same software package, try to print using a backup copy of your document.

Conflicts with Port Sharing Devices?

A probable cause for this problem is conflicts between the printer and other port sharing devices such as zip drives and other printers. Do not share the port with another device, or disable bi-directional communication and try again. To disable bi-directional communication:

- 1 Open the Toolbox. Select **Printer Status** and click **Preferences**.
- 2 Uncheck **Enable Bi-directional Communication**.

Nothing Works?

If none of these solutions work, this problem is likely caused by a failure in the printer or computer system. Send printer for repair.



Wrong Fonts

Possible causes:

Fonts Used Incorrectly in the Document?

Make sure you correctly apply the font you have chosen. For example, in a paint program place the words in the desired size; don't enlarge by dragging and sizing.

Font Available on Computer?

The fonts used in the document might not match the fonts currently available in your Windows system. Or the type of font used is not designed to be printed. See if the font that is printing incorrectly is available in your software program's font selection box, and if it is a TrueType font.

Wrong Printer Selected?

Check to make sure your HP DeskJet printer is selected as the current or default printer.

- 1 In the **Printers** folder, click **HP DeskJet icon**.
- 2 From the **File** menu, click **Set As Default**.

Nothing Works?

If none of these solutions work, this problem is likely caused by a failure in the printer or computer system. Send printer for repair.

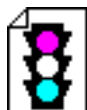

Wrong Colors

Possible causes:

Colors are Completely Different?

When colors are completely wrong (for example, when green prints as blue or yellow), the color cartridge might have run out of one or more colors of ink. The best way to check this is to perform a Self-Test to check the colors, followed by a cleaning procedure.

To print a Self-Test:

- 1 Double-click the Toolbox icon on the Desktop or in the Printer Group.
- 2 Select **Printer Services** and click **Print a Self-Test Page**.

To clean the print cartridges:

- 1 Open the ToolBox by double-clicking the HP 1220C icon on your desktop or click **Start**, select **Programs**, followed by “**HP 1220C Series**“, followed by HP 1220C ToolBox.
- 2 Choose **Printer Services** and select **Clean Print Cartridges**.
- 3 Follow the instructions on the screen to clean the cartridges.

Colors are Gray or the Wrong Shade?

- If colors are printing in shades of gray, **Print in Grayscale** is probably selected in HP's print settings dialog box. For color printing, select **Imaging** and uncheck **Print in Grayscale**.
- If hue or tone of color is shifted, the wrong setting might be selected in HP's print settings dialog box. Select **Imaging** and make sure the color sliders are centered.

For further instructions on changing print settings, see *Changing Default Print Settings* on page 3-4.

Incorrect Media Type?

Paper that is colored causes the mismatch in the printout. Try printing on plain white paper.

Nothing Works?

If none of these solutions work, this problem is likely caused by a failure in the printer or computer system. Send printer for repair.

Slow Printing

To enhance the performance of your printer, check the following:

System Configuration

- The minimum PC configuration for this printer is a Pentium-class computer with 16MB RAM (24MB RAM for Windows NT 4.0).
- For printing of an A3 or B-size file, it is recommended that you have about 50MB of free drive space in your system. Graphic intensive or photographic images may require more free space.

Port and Cable Settings (Windows 95 only)

- Set port selection to ECP. Refer to the manual that comes with your PC system for more information on how to change your port setting or contact your computer manufacturer.
- Use a IEEE-1284 parallel cable to enable bi-directional communication.

PhotoREt

You are printing on Photo Paper and have disabled PhotoREt. To lessen the time taken to print, turn the PhotoREt Option on (the default setting).

Hardware Troubleshooting

Take a few moments to complete the *The HP DeskJet 1220C Quick Checkup* on page 6-28 before you troubleshoot any hardware problems. Next, proceed to *Troubleshooting Hardware Problems* on page 6-29 and follow this decision tree each time you troubleshoot a hardware problem. A YES answer allows you to proceed to the next major step. A NO answer shows you where to turn to conduct further testing. After you complete any additional testing and/or correct that part of the problem, return to *Troubleshooting Hardware Problems* and continue to follow the decision tree.

Note

Replace one part or assembly at a time to isolate the printer problem.

Troubleshooting Tools

You will need the following tools:

- Digital Multimeter.
- Cotton swabs and a cotton cloth.
- TORX® screwdriver with T-08, T-10 and T-20 screw bits or T-08, T-10 and T-20 TORX screwdrivers. A magnetized screwdriver tip is helpful.
- Small flathead screwdriver.
- Electrostatic Discharge (ESD) workstation or ESD dissipative straps (either heel straps or wrist straps).

Diagnostic Tools

There are three sets of diagnostic tools that will help you to troubleshoot the printer.

- Self-Test and Sample page.
- Diagnostic tests.
- DeskJet 1220C Software Diagnostic Test.

Take some time to familiarize yourself with how these tools work and what problems they can help you diagnose. See *Diagnostic Tools* on page 6-59 for a complete explanation of these tools.

The HP DeskJet 1220C Quick Checkup

Check the Print Cartridges

- ✓ Lock the Cleanout Trough into position.
- ✓ Plug in the printer.
- ✓ Power on the printer.
- ✓ Open the Access Door. The Carriage will move to the center of the printer.
- ✓ Ensure all tape has been removed from the print cartridges.
- ✓ Verify that the print cartridges are properly installed and OK by confirming that the yellow arrow on the Carriage points to this icon: 

Check the Printer

- ✓ Pull out the Input Tray and remove any media.
- ✓ Examine the Encoder Strip carefully.
- ✓ Remove the Cleanout Trough and remove any jammed media.
- ✓ Reinstall the Cleanout Trough and lock it in position.

Check the Sample Page

- ✓ Set the width and length adjusters and properly load media.
- ✓ Close the Access Door.
- ✓ Ensure the Input Tray is properly secured in printer.
- ✓ Power on the printer.
- ✓ Print a Sample page—Press the Resume Button and release it when the Resume Light turns off.
- ✓ Watch the printer for smooth paper feed.
- ✓ Examine the Sample page for incomplete text or graphics.

If you successfully printed a Sample page with good print quality, then the printer is OK. If not, see *Troubleshooting Hardware Problems* on page 6-29.

Troubleshooting Hardware Problems

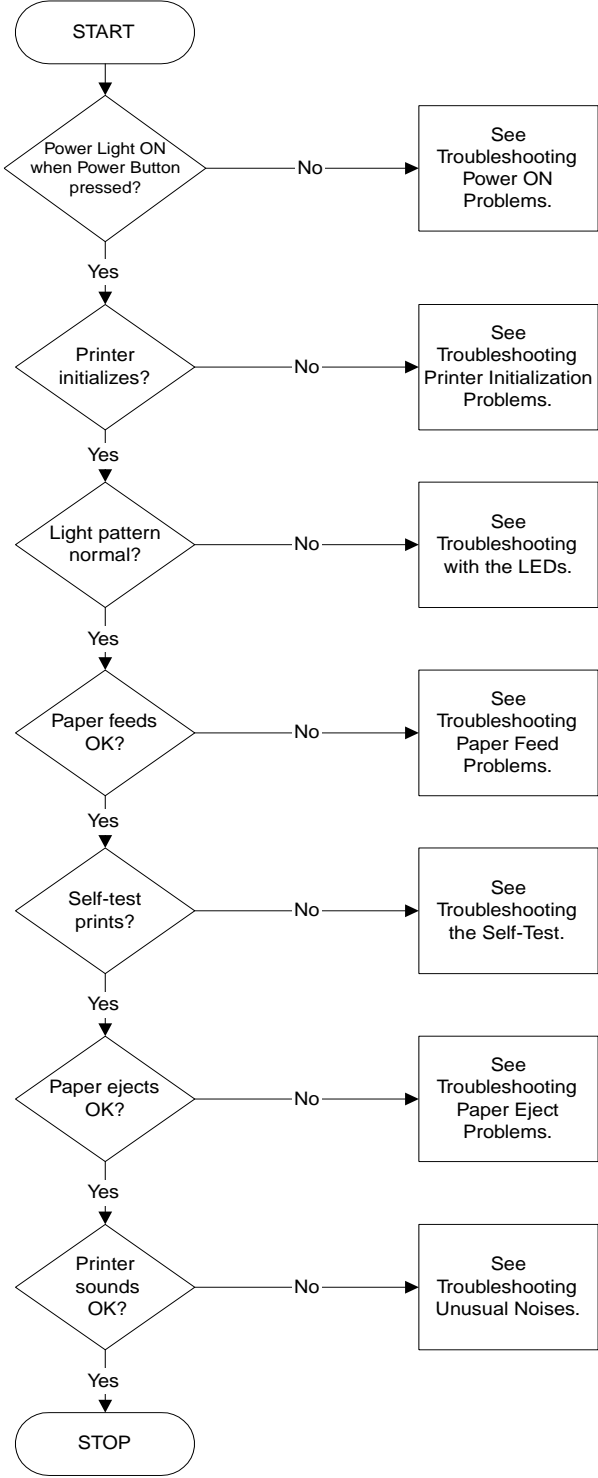

Tree 6.5 Troubleshooting Hardware Problems

Troubleshooting Power On Problems

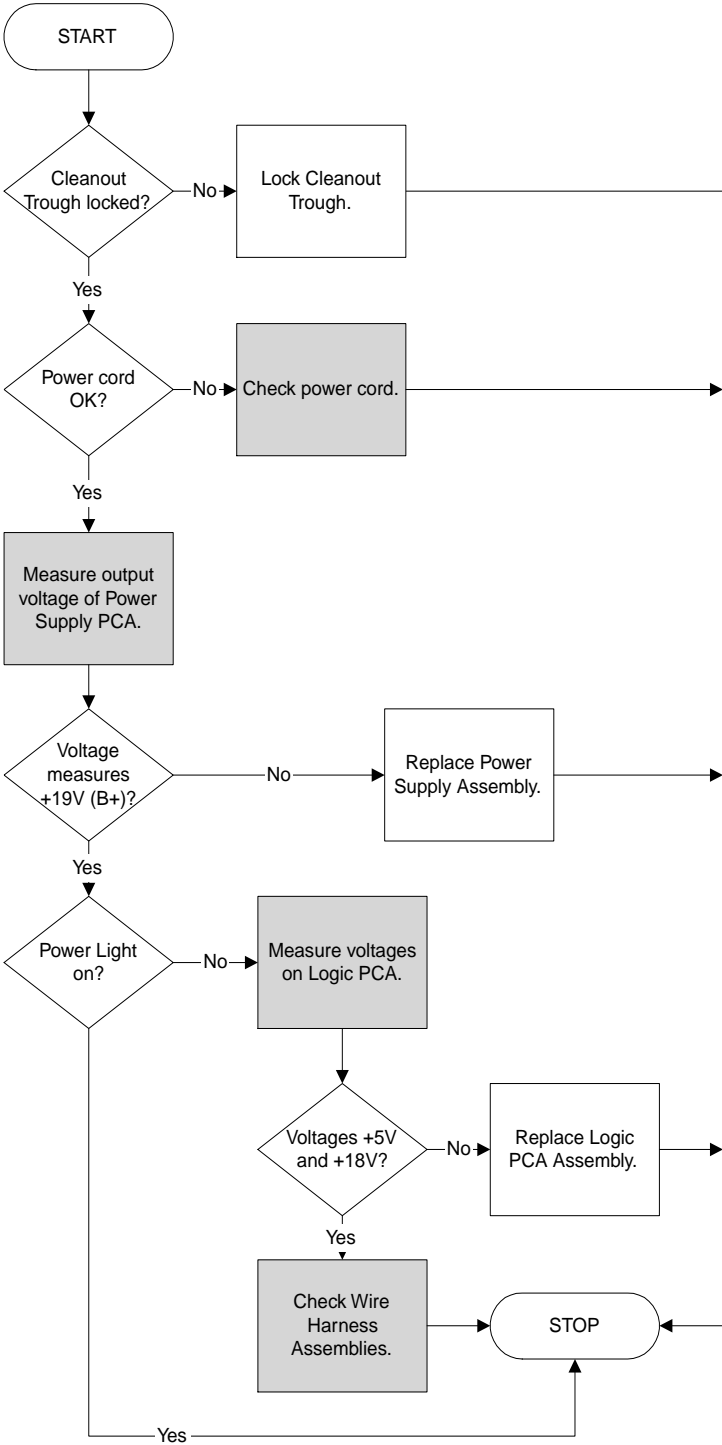

Tree 6.6 Troubleshooting Power On Problems

Power Cord

Make sure the printer is connected to the power cord, that the power cord is plugged in, and that the power cord can handle 230V.

To test the power cord:

- 1 Power off the printer.
- 2 Unplug the power cord and replace it with a power cord that works.
- 3 Power on the printer. If the printer now works, then your power cord is faulty.

Note

The power cord cannot be repaired. If it is defective, it should be discarded or returned to the supplier.

Measure Voltage of Power Supply Assembly

- 1 Disconnect the Power Supply Harness Assembly from the Power Supply PCA.
- 2 Use a multimeter to check the output voltage of the Power Supply Assembly. It should measure +19V (B+).
- 3 Reconnect the Power Supply Harness Assembly when you are finished.
- 4 Turn the printer off and the power the printer on again.

To replace the Power Supply Assembly, see page 7-12.

Measure Voltage of Logic PCA

- 1 Use a multimeter to check the output supply voltage of the Arabian Analog ASIC on the Logic PCA. It should measure +5V (B+).
- 2 Use a multimeter to check the input supply voltage of the Power Connector to the Output Ramp Motor Driver on the Logic PCA. It should measure +32V (B+).

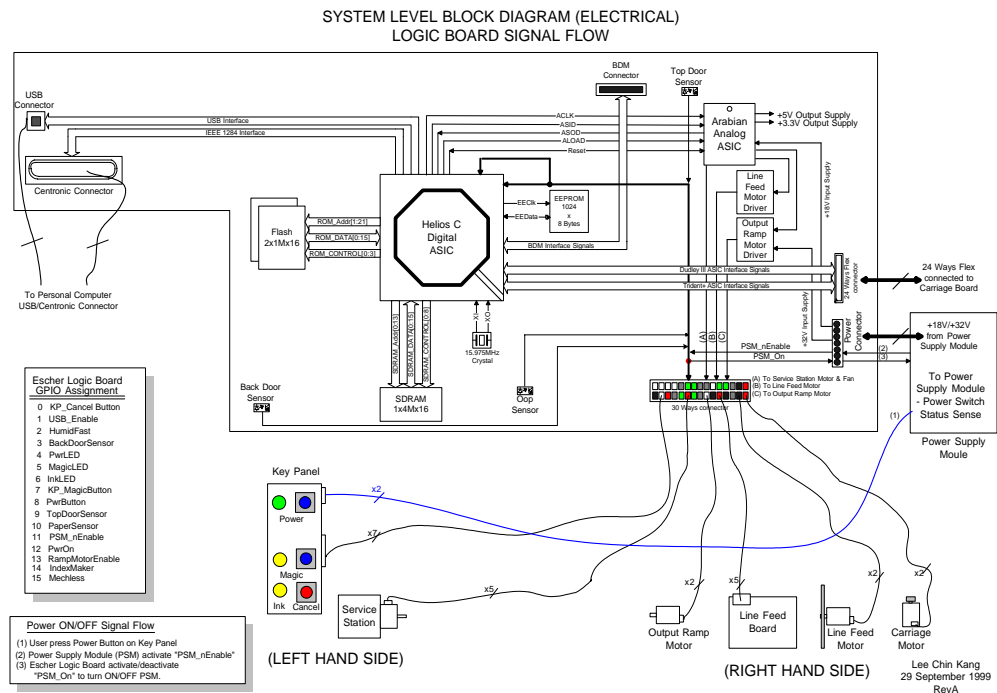

Figure 6.7 Block Diagram of Electrical System

To replace the Logic PCA, see page 7-10.

Wire Harness Assemblies

Check that all connections to the Main Logic Harness Assembly and Power Supply Harness Assembly are solid and that all connectors are attached firmly to the wires. Also ensure that none of the wire insulation is worn or missing.

To replace the Main Logic Harness Assembly, see page 7-14.

To replace the Power Supply Harness Assembly, see page 7-35.

Troubleshooting Printer Initialization Problems

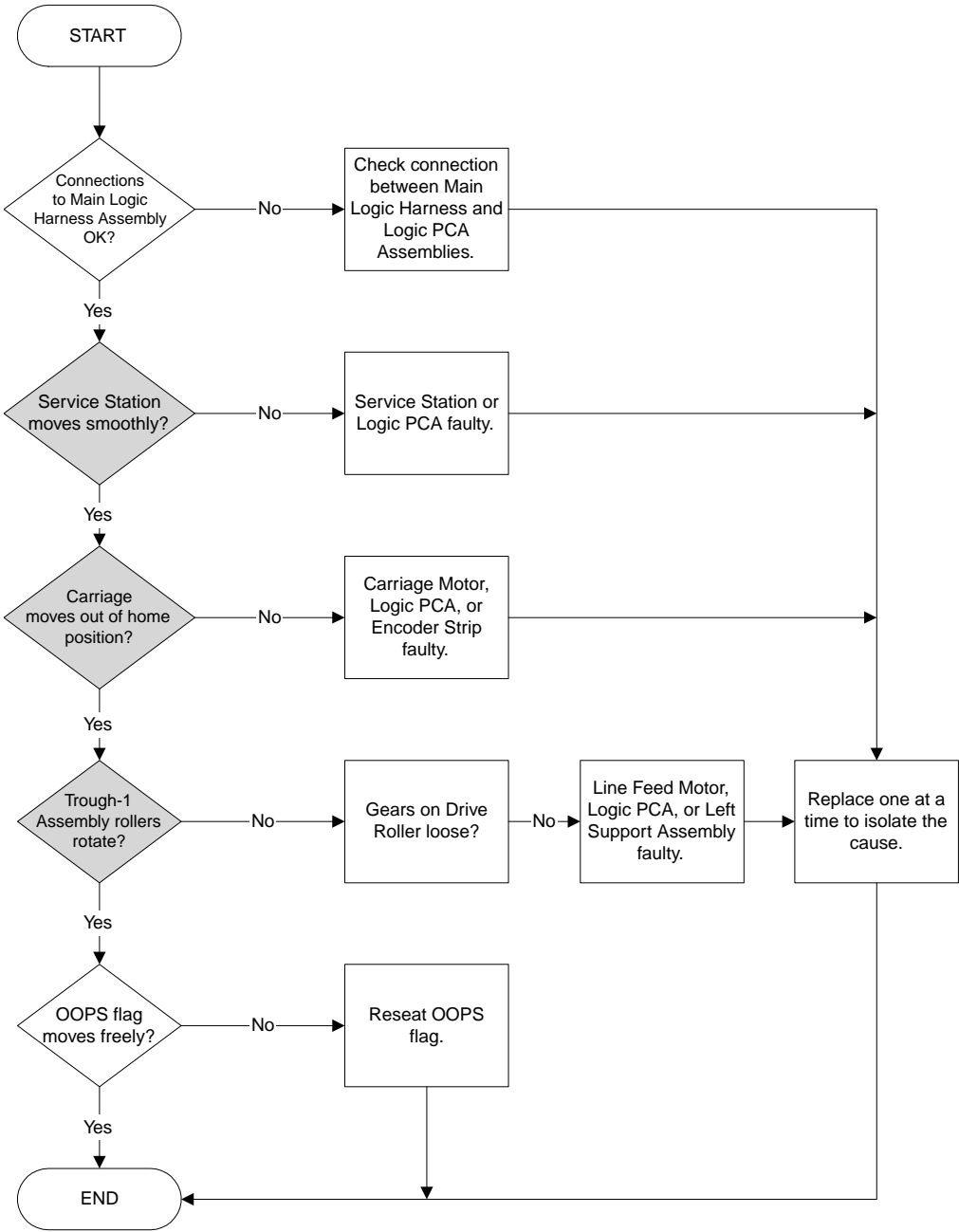

Tree 6.7 Troubleshooting Printer Initialization Problems

Service Station Mechanism Moves Smoothly?

Rotate the gears of the Service Station Motor Assembly to make sure the Wiper Assembly can move freely within the Service Station Mechanism Assembly.

To replace the Service Station, see page 7-19.

To replace the Logic PCA, see page 7-10.

Carriage Assembly Moves out of Home Position?

If the Carriage Assembly does not move out of the home position or return to the home position, clean the electrical contacts on the print cartridges and print cradle.

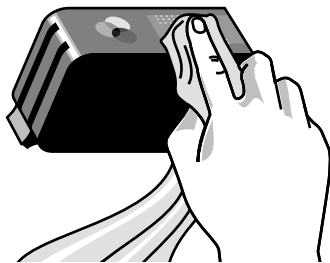
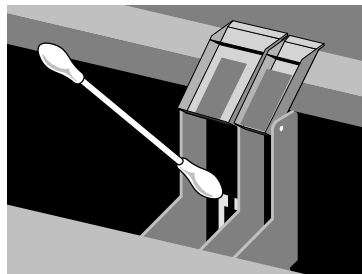

- 1 Remove the print cartridge from the printer.
- 2 Clean the electrical contacts on the print cartridge cradle with a dry cotton swab.
- 3 Clean the electrical contacts on the print cartridge with a dry, lint free cloth. To prevent the electrical contacts from damage, you should wipe the contacts only once. Do not wipe the ink nozzles on the print cartridge.
- 4 Re-install the print cartridge.

Figure 6.8 Cleaning Electrical Contacts

To replace the Logic PCA, see page 7-10.

To replace the Encoder Strip, see page 7-17.

To replace the Carriage Motor Assembly, see page 7-18.

Trough-1 Assembly Rollers Rotate?

To check the gears on the Drive Roller Assembly, see page 7-31.

To replace the Logic PCA, see page 7-10.

To replace the Left Support Assembly, see page 7-34.

Troubleshooting Using LEDs

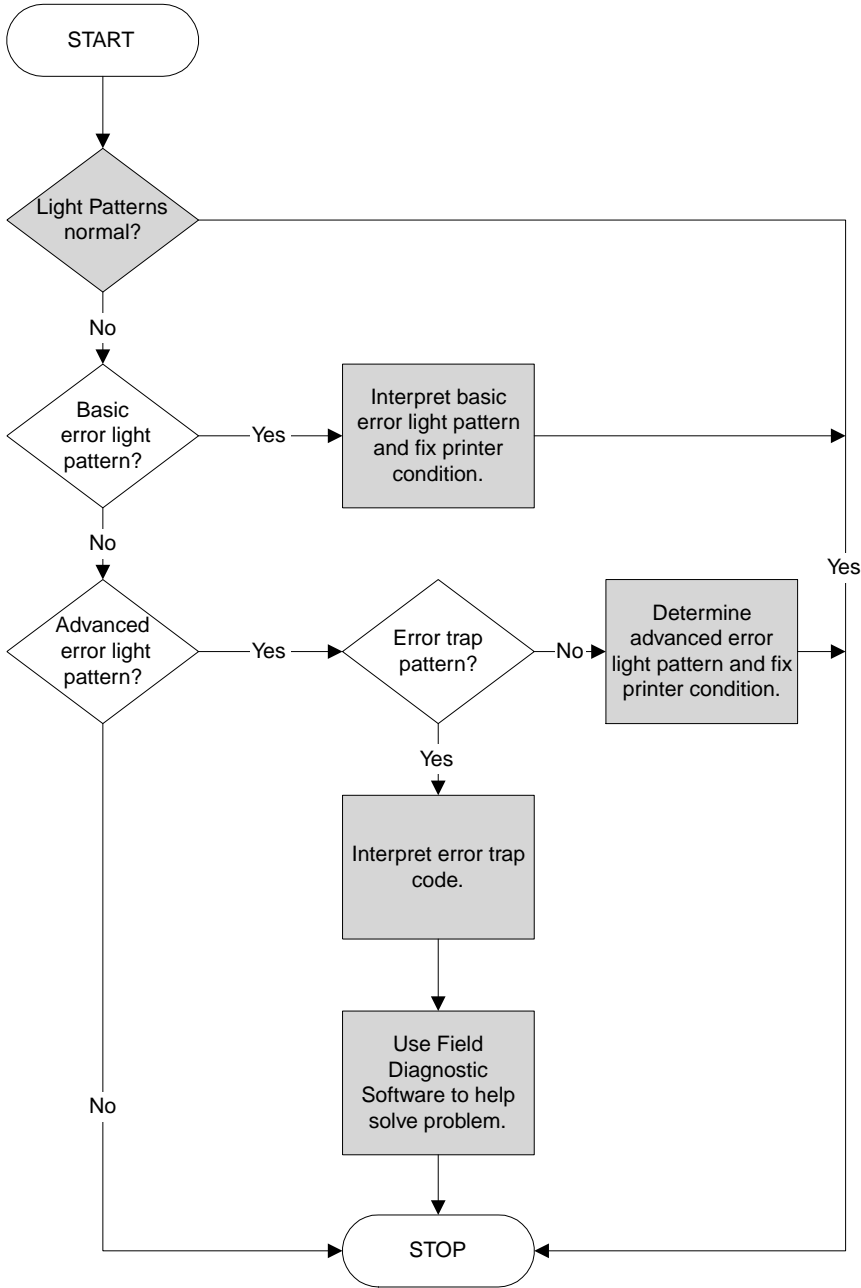







Tree 6.8 Troubleshooting Using LEDs

Printer Lights During Normal Printing

The following table describes how the LEDs appear during normal printing.

Table 6.5 Printer Lights During Normal Printing

If...	Then...
  All lights are OFF	The printer is OFF.
  The Power Light is ON	The printer is ready to print. You can send a document to the printer.
  The Power Light is blinking	The printer is receiving data from the computer or is printing. Wait for the document to print.

Basic Error Light Patterns

The pattern of the printer lights provides both printer status and printer error messages. Some printer conditions are also reported in the printer driver.

Table 6.6 Basic Error Light Patterns



Printer Lights	Possible Causes
  Power Light On and Resume Light blinks	There is an I/O (Input/Output) Stall. <ul style="list-style-type: none"> • The printer is out of paper. • Paper needs to be ejected. • There is a media size or type mismatch. • The printer is no longer receiving data. • The printer is waiting for the page to dry before printing the next page. • Manual Duplex is waiting for user's action.

Table 6.6 Basic Error Light Patterns

	<p>Power Light On and Print Cartridge Light blinks</p>	<ul style="list-style-type: none"> • Incorrect installation. • Print cartridge damaged or not usable. • Low or out of ink. • Wrong type of print cartridge.
	<p>Power and Resume Lights blink (synchronous)</p>	<p>There is a Carriage Stall. Power off the printer and open the Access Door. Remove any packing materials or excess paper from the printer. When there are no obstructions, power the printer off and then on again.</p>
	<p>Resume Light blinks</p>	<p>There is a paper jam or paper motor stall. Clear paper jam.</p>
	<p>All Lights blink</p>	<p>This is an error trap code. Turn the printer off, then on again. If all the lights still blink, the problem is likely caused by a failure in the printer. Send printer for repair.</p>

The Power Light blinks when printing. This is normal.
 The Power Light blinks 2-on, 1-off when a print job is being cancelled.

Advanced Error Light Patterns

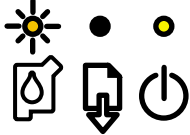
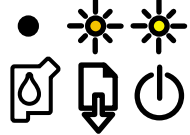
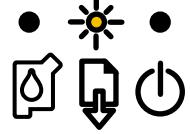
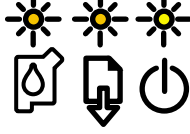
Table 6.7 Advanced Error Light Patterns

Printer Lights	Symptom	Condition	Solution	
	All lights off	Light pattern does not change if you press the Power Button.	Power Button faulty.	Check or change: Main Logic Harness Assembly, page 7-14; Power Supply PCA, page 7-12; Keypanel PCA, page 7-14; Logic PCA, page 7-10; Carriage PCA, page 7-36.
	Power Light blinks	Power Light continues to blink after all printer jobs are completed.	Power Button faulty.	Change Logic PCA, page 7-10. If still blinking, check the printer driver.
	Resume Light blinks	Light pattern does not change if you press and release the Resume Button.	Resume Button faulty.	Ensure Resume Button is not stuck. Check or change: Cable connection from Logic to Keypanel PCA; Keypanel PCA, page 7-14; Logic PCA, page 7-10.
	Print Cartridge Light blinks	Light pattern does not change if you open and close the Access Door.	Access Door sensor faulty.	Ensure Access Door flag is not stuck. Change Logic PCA, page 7-10.
	Power and Resume Lights on	Light pattern does not change if you install and lock the Cleanout Trough.	Rear Access Sensor on Logic PCA faulty.	Ensure wire harnesses are properly connected. Change Logic PCA, page 7-10.

Table 6.7 Advanced Error Light Patterns

	<p>Power Light On and Resume Light blinks</p>	<p>Light pattern does not change if you press the Power Button or Resume Button.</p>	<p>Input/Output Stall. Out of paper, paper jam or problem with the paper feed.</p>	<p>Check or change: Paper feed, page 6-47; OOPS flag; OOPS sensor and if faulty, change Logic PCA, page 7-10; Output Belt, page 7-16; Carriage PCA, page 7-36; Encoder Disk, page 7-16; Pick Separator, page 7-36; Logic PCA, page 7-10; Pick Roller Assembly, page 7-25; Line-feed Motor, page 7-34.</p>
	<p>Power Light On and Print Cartridge Light blinks</p>	<p>Carriage sits in middle of the printer.</p>	<p>Possible problem with print cartridge identification or Access Door sensor faulty.</p>	<p>Change BOTH print cartridges, page 5-7. Ensure Access Door flag is not stuck. Check or change: Logic PCA, page 7-10; Flex Cable, page 7-28; Access Door Assembly, page 7-9; Carriage Assembly, page 7-27; Carriage PCA, page 7-36; Service Station, page 7-19.</p>
	<p>Power and Resume Lights blink (asynchronous)</p>	<p>Paper is jammed.</p>	<p>Paper Stall Error.</p>	<p>Check for paper jam. Check 32V on Power Supply Assembly and replace PCA if necessary, page 7-12. Check or change: Wire harness connections; Encoder Disk, page 7-16; Linefeed motor, page 7-34; Logic PCA, page 7-10.</p>

Table 6.7 Advanced Error Light Patterns

	<p>Power and Resume Lights blink (synchronous)</p>	<p>Carriage Motor has no holding torque.</p>	<p>Carriage Stall or Logic PCA is not properly reading the Encoder Strip.</p>	<p>Ensure Carriage is not stuck on the Service Station. To change Service Station, see page 7-19. Ensure wire harnesses properly connected. Check or change: Encoder Strip, page 7-17; Carriage Belt, page 7-28; Logic PCA, page 7-10; Spot Sensor Assembly, page 7-19; Carriage Motor, page 7-18.</p>
	<p>All Lights blink</p>	<p>Light pattern does not change if you power the printer off and on.</p>	<p>Error trap.</p>	<p>See <i>Determining Error Trapped Codes</i> on page 6-41.</p>

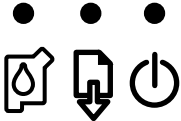
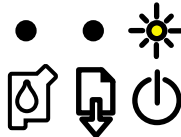
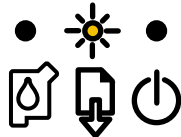
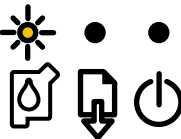
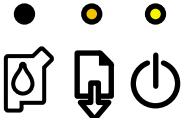
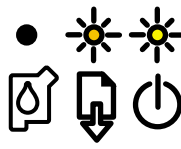
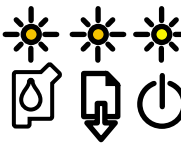
Determining Error Trapped Codes

Note

The error code associated with the Error Trap condition is stored in non-volatile memory.

If all three lights are blinking, press the Resume Button once. The LEDs will blink 32 times in a pattern of 0's and 1's. The first four blinks determine the first digit of the error code, the second four blinks determine the second digit. Follow this pattern to determine all eight digits. The digits are binary encoded; if the Power and Resume Buttons blink, then the digit is a 0, if all three lights blink, then the digit is a 1. The following table will help you interpret the blink code:

Table 6.8 Interpreting the Blink Code

Blink Sequence	Digit	Blink Sequence	Digit
0 0 0 0	=0	1 0 0 0	=8
0 0 0 1	=1	1 0 0 1	=9
0 0 1 0	=2	1 0 1 0	=A
0 0 1 1	=3	1 0 1 1	=B

Table 6.8 Interpreting the Blink Code

0	1	0	0	=4	1	1	0	0	=C
0	1	0	1	=5	1	1	0	1	=D
0	1	1	0	=6	1	1	1	0	=E
0	1	1	1	=7	1	1	1	1	=F

Double-check your outcome by running a Single Diagnostic Test:

- 1 Power on the printer.
- 2 Press and hold the Power Button and press the Resume Button four times.
- 3 Release the Power Button. The printer prints a Single Diagnostic Test page with the last error trapped code.

If the Single Diagnostic Test page will not print, repeat the steps above, pressing the Resume Button twelve times instead of four times.

Note

Always use the blink pattern to determine the error trap code before you perform a Single Diagnostic Test; sometimes the printer is too damaged to print a Single Diagnostic Test Page.

Error Trapped Codes

The first digit is the Assert Type.

Note

The Assert Type code number and associated code may only be useful to firmware technicians.

- If the Assert Type is a 0 or a 1, it is a Line Number Assert. Break the error code down in the following way:

Example Error Code: 012B0872 = 012B | 0872.

The first set of digits, 012B, is a line number. Convert the hexadecimal digit to decimal. It becomes line number 299. If you believe the printer problem is with the firmware, this information may be useful to a firmware technician.

The second set of digits, 0872, is the CRC encoded filename. Check the *File Name CRCs* section. The filename may help you make an educated guess where the printer problem is located or which firmware technician to con-

sult for help.

Note

Do not rely solely on the CRC encoded filename to determine which part of the printer is faulty; the CRC encoded filename may be misleading. Use it as one of the many tools you have to troubleshoot the printer. These tools include the troubleshooting trees, the diagnostic tools, your knowledge of the printer, and your troubleshooting experience.

- If the Assert Type is not a 0 or a 1, then break the error code down in the following way:

Example Error Code: C0020139 = C | 002 | 01 | 30.

The first digit is the Assert Type. In the example above, C (HW) indicates a hardware problem.

The second set of digits is the Assert Component ID. In the example, 002 (MECH) suggests a mechanism error.

The third set of digits is the Assert Product Type. In the example, 01 refers to a Venice product.

The final set of digits is the error code. In the example, 30 indicates ERROR_MECH_CARRIAGE_BOARD_OFF and suggests which area of the printer to focus on for troubleshooting.

Table 6.9 Error Trapped Codes

Error	Error Trap Code	Solution
Assert Types		
ASSERT_TYPE_LINE_NUM	0x00	
ASSERT_TYPE_LINE_NUM_BIG	0x01	
ASSERT_TYPE_MFG	0x08	
ASSERT_TYPE_LOG	0x09	
ASSERT_TYPE_MEM	0x0B	
ASSERT_TYPE_HW	0x0C	
ASSERT_TYPE_FW	0x0E	
ASSERT_TYPE_SYS	0x0F	
Assert Products		
PROD_ID_POLARIS	0x00	
PROD_ID_VENICE	0x01	
PROD_ID_WIZARD	0x02	

Table 6.9 Error Trapped Codes

PROD_ID_BROADWAY	0x03
PROD_ID_ESCHER	0x04
Assert Component ID	
ASSERT_ID_STACK_CHECK	0x01
ASSERT_ID_MECH	0x02
ASSERT_ID_PEN	0x03
ASSERT_ID_CARRIAGE	0x04
ASSERT_ID_PAPER	0x05
ASSERT_ID_SS	0x06
ASSERT_ID_UDW	0x07
ASSERT_ID_PROCESSOR	0x08
ASSERT_ID_SWEEP_MGR	0x09
ASSERT_ID_REPORTS	0x0A
ASSERT_ID_PCL	0x0B
ASSERT_ID_PORTSEL	0x0C
ASSERT_ID_P1284	0x0D
ASSERT_ID_CBIO	0x0E
Carriage errors	
ERROR_CARRIAGE__SHUTDOWN_WHILE_MOVING	0x01
Cbio errors	
ERROR_CBIO__A2D_READ_FAILED	0x01
ERROR_CBIO__CARRIAGE_BOARD_NOT_RESPONDING	0x02
ERROR_CBIO__DUDLEY_CALIBRATION_VALUE_INVALID	0x03
ERROR_CBIO__DUDLEY_CALIBRATION_PWM_OUT_OF_RANGE	0x04
Processor errors	
ERROR_PROCESSOR__ACCESS_ERROR	0x08
ERROR_PROCESSOR__ADDRESS_ERROR	0x09
ERROR_PROCESSOR__ILLEGAL_INSTRUCTION	0x0A
ERROR_PROCESSOR__PRIVELEGE_VIOLATION	0x0B
ERROR_PROCESSOR__UNIMPLEMENTED_A_OPCODE	0x0C
ERROR_PROCESSOR__UNIMPLEMENTED_F_OPCODE	0x0D
ERROR_PROCESSOR__FORMAT_ERROR	0x0E
ERROR_PROCESSOR__UNINITIALIZED_INTERRUPT	0x0F
Generic Firmware Errors	
ERROR__FIRM_TABLE_SIZE_MISMATCH	0x7F

Table 6.9 Error Trapped Codes

ERROR__FIRM_TABLE_NAME_TOO_LONG	0x80
ERROR__BAD_PROVIDED_IFC_INDEX	0x81
ERROR__BAD_REQUIRED_IFC_INDEX	0x82
ERROR__BAD_MESSAGE_SEND	0x83
ERROR__UNKNOWN_COMMAND	0x84
ERROR__UNEXPECTED_COMMAND	0x85
ERROR__UNIMPLEMENTED_COMMAND	0x86
ERROR__OUT_OF_ROOM	0x87
ERROR__PARAM_OUT_OF_RANGE	0x88
ERROR__PARAM_VALUE_TOO_SMALL	0x89
ERROR__PARAM_VALUE_TOO_LARGE	0x8A
ERROR__PARAM_MISMATCH	0x8B
ERROR__UNEXPECTED_VALUE	0x8C
ERROR__UNEXPECTED_NULL_PTR	0x8D
ERROR__EXPECTED_NULL_PTR	0x8E
ERROR__LESS_THAN_ZERO	0x8F
ERROR__DIVIDE_BY_ZERO	0x90
Mechanism Errors	
ERROR_MECH_MEDIA_JAM	0x01
ERROR_MECH_PAPER_STALL	0x02
ERROR_MECH_CARRIAGE_STALL	0x03
ERROR_MECH_LESS_THAN_ZERO_TIMER_UNIT	0x04
ERROR_MECH_UNEXPECTED_TIMER_UNIT	0x05
ERROR_MECH_UNEXPECTED_TIMER_STATE	0x06
ERROR_MECH_NOT_MODIFIER_TIMER	0x07
ERROR_MECH_UNKNOWN_TIMER_COMMAND	0x08
ERROR_MECH_TIMERS_NOT_ACTIVE	0x09
ERROR_MECH_BAD_STARTUP	0x0a
ERROR_MECH_UNKNOWN_TIMER_UNITS	0x0b
ERROR_MECH_IN_JOB_TOLD_TO_START_JOB	0x0c
ERROR_MECH_NOT_IN_JOB_TOLD_TO_END	0x0d
ERROR_MECH_NO_CARRIAGE_BOARD	0x2f
ERROR_MECH_CARRIAGE_BOARD_OFF	0x30
ERROR_MECH_CAL_NO_GAIN_FOUND	0x40
ERROR_MECH_CAL_BAD_A2D_MIN	0x41
ERROR_MECH_CAL_CANT_GENERATE_A_GAIN	0x42
ERROR_MECH_CAL_CANT_GENERATE_A_OFFSET	0x43

Table 6.9 Error Trapped Codes

ERROR_MECH_CAL_CANT_GENERATE_B_GAIN	0x44
ERROR_MECH_CAL_CANT_GENERATE_B_OFFSET	0x45
ERROR_MECH_CAL_BAD_CROSSPOINTS	0x46
Pen Errors	
ERROR_PEN__BAD_TRIDENT_PARITY	0x01
ERROR_PEN__TRIDENT_A2D_INCOMPLETE	0x02
ERROR_PEN__REGULATOR_FAILURE	0x03
ERROR_PEN__NOT_MANUAL_IO_MODE	0x04
ERROR_PEN__NOT_PRINTING_IO_MODE	0x05
ERROR_PEN__NOT_AUTOSTROBING_IO_MODE	0x06
ERROR_PEN__BAD_PEN_WORD_OUT_PARM	0x29
ERROR_PEN__CARRIAGE_BOARD_OFF	0x30
Portsel Errors	
ERROR_PORTSEL_RESERVED_CHARACTER	0x01
ERROR_REPORTS	0x00
Sweep Manager Errors	
SWEEP_MGR_INVALID_NOZZLE	0x00
SWEEP_MGR_NO_DATA_PRESENT	0x01
SWEEP_MGR_NOT_IN_DD	0x02
SWEEP_MGR_INVALID_CAR_SP	0x03
SWEEP_MGR_INVALID_DIR	0x04
SWEEP_MGR_DATA_BUF_FULL	0x05
SWEEP_MGR_NEG_MOVE	0x06
SWEEP_MGR_INVALID_RES	0x07
SWEEP_MGR_TOO_MANY_SWEEPS	0x08
SWEEP_MGR_NO_DATA_FOUND	0x09
SWEEP_MGR_INVALID_RSPEED	0x0a
SWEEP_MGR_INVALID_FIRE_RES	0x0b
SWEEP_MGR_MISMATCH_KCMY_POS	0x0c

Troubleshooting Paper Feed Problems

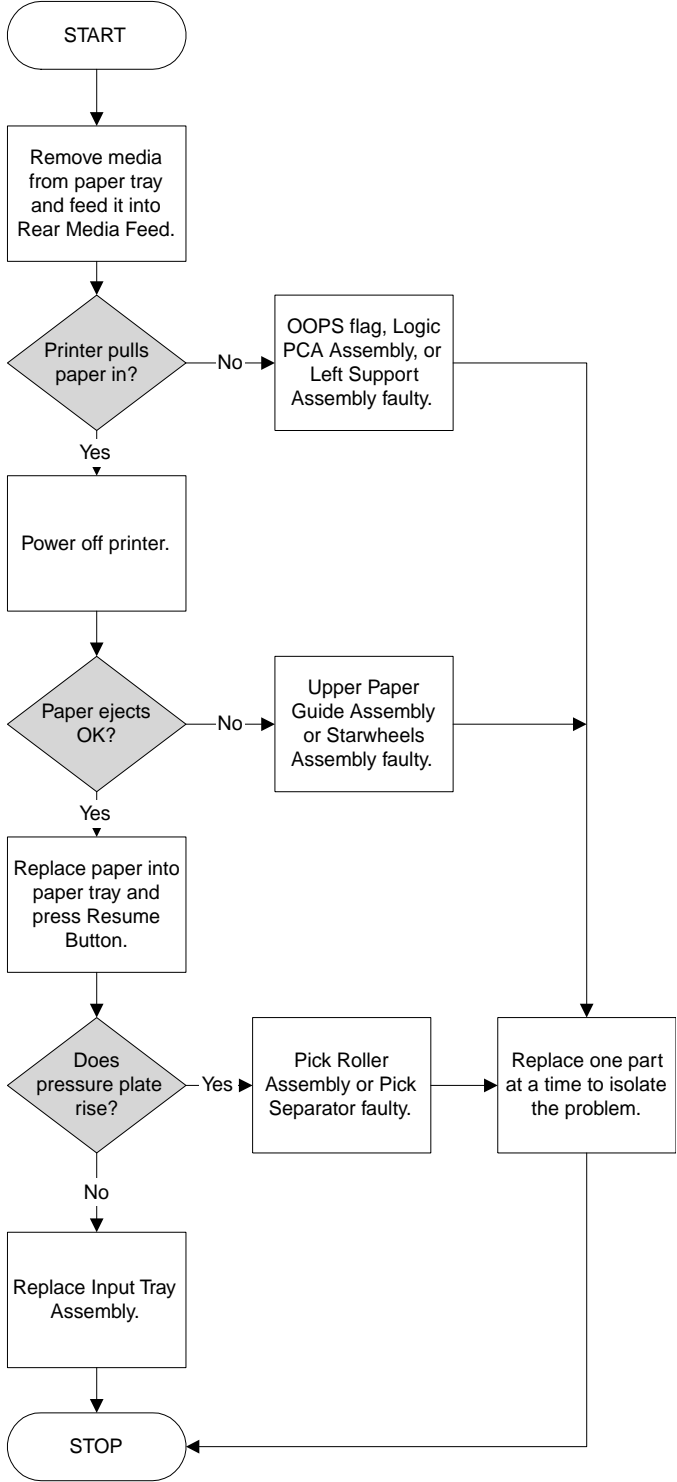

Tree 6.9 Troubleshooting Paper Feed Problems

Paper does not Pull In?

To replace the Logic PCA, see page 7-10.

To replace the Left Support Assembly, see page 7-34.

Paper does not Eject?

To replace the Starwheels Assembly, see page 7-21.

To replace the Upper Paper Guide Assembly, see page 7-29.

Pressure Plate does not Rise?

The pressure plate is part of the Input Tray Assembly.

To replace the Pick Roller Assembly, see page 7-25.

To replace the Pick Separator, see page 7-36.

To replace the Input Tray Assembly, see page 7-23.

Troubleshooting the Self-Test

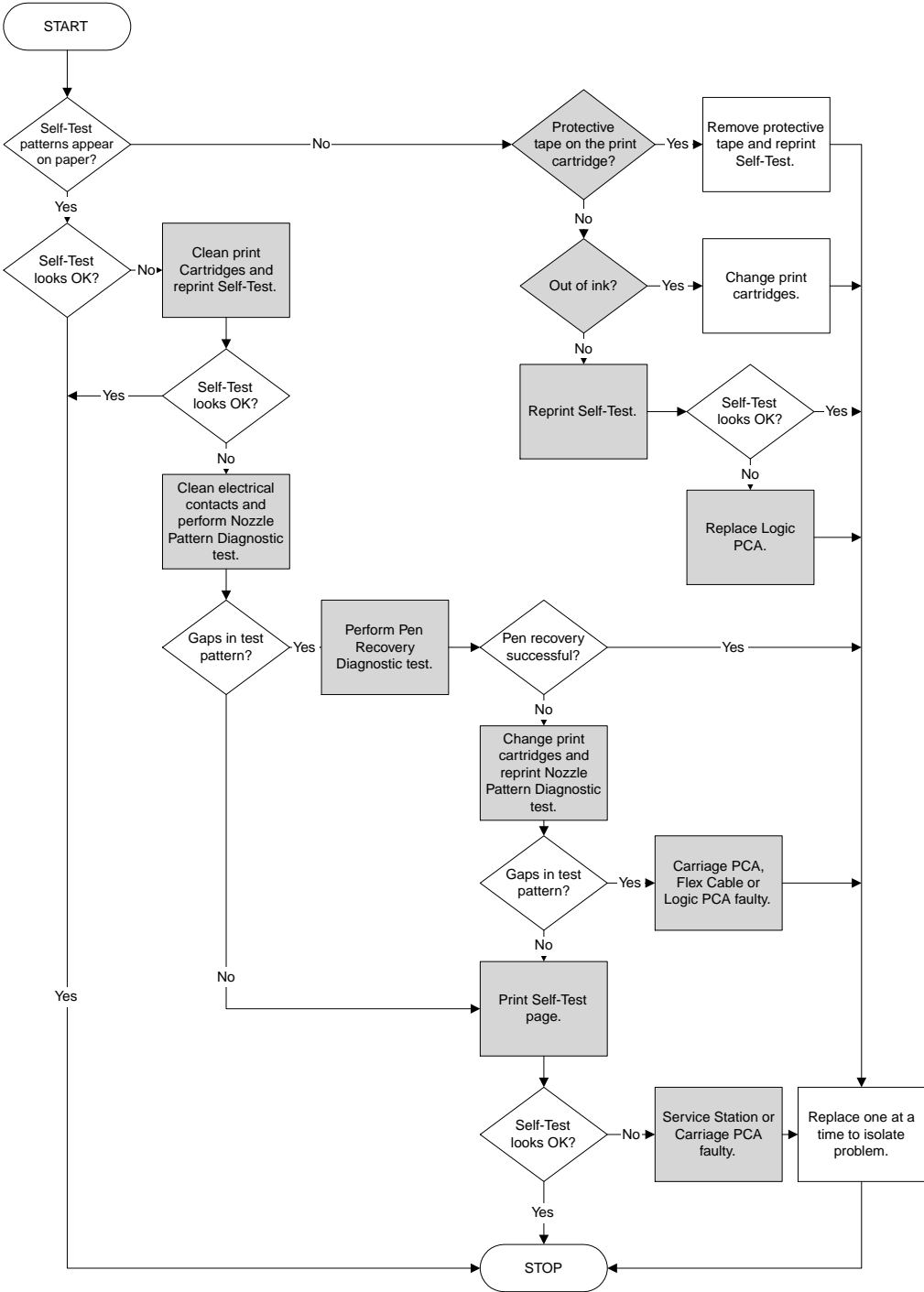

Tree 6.10 Troubleshooting the Self-Test

Protective Tape on the Print Cartridge?

Each new print cartridge is packaged with protective plastic tape covering the ink nozzles. Check each print cartridge and remove tape if necessary.

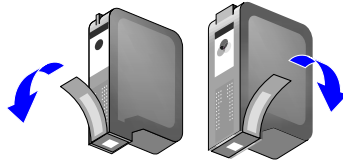

Figure 6.9 Removing Protective Tape from Ink Nozzles

Print a Self-Test

- 1 Open the ToolBox by double-clicking the HP 1220C icon on your desktop or click **Start**, select **Programs**, followed by “**HP 1220C Series**“, followed by HP 1220C ToolBox.
- 2 Select **Printer Services** and click **Print a Self-Test Page**.

See page 6-59 for an example of a Self-Test page.

Out of Ink?

If you are printing black text and a blank page prints, your black print cartridge may be empty. Replace the black print cartridge. See *Changing the Print Cartridges* on page 5-7.

Note

Open the Access Door when you suspect a print cartridge problem. Inside, you will see icons showing cartridge problems. If there is a problem, the yellow arrow on the cartridge cradle points to the icon that indicates the problem.

Logic PCA Assembly

To replace the Logic PCA, see page 7-10.

Clean Print Cartridges

Clean the print cartridges when lines or dots are missing from printed text or graphics.

Note

Do not clean the print cartridge unnecessarily because this wastes ink and shortens the life of the print cartridges.

- 1 Double-click the Toolbox icon on the Desktop or in the Printer Group.
- 2 Choose **Printer Services** and select **Clean Print Cartridges**.

- 3 Follow the instructions on the screen to clean the cartridges.

Caution

The ink in the print cartridges has been carefully formulated by Hewlett-Packard to ensure superior print quality and compatibility with your printer. Damage to the printer or the print cartridge resulting from modifying or refilling the print cartridge is not the responsibility of HP.

Clean the Electrical Contacts

If the carriage assembly does not move out of the home position or won't return to the home position, clean the electrical contacts on the print cartridge. Poor contact between the print cartridges and cartridge cradles may also affect the quality of the printout.

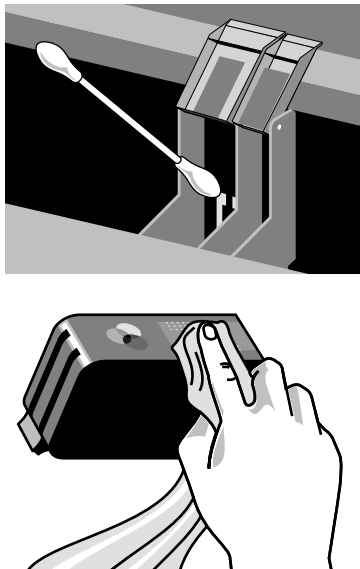

- 1 Remove the print cartridge from the printer.
- 2 Clean the electrical contacts on the print cartridge cradle with a dry cotton swab.
- 3 Clean the electrical contacts on the print cartridge with a dry lint free cloth. To prevent the electrical contacts from damage, you should wipe the contacts only once. Do not wipe the ink nozzles on the print cartridge.
- 4 Re-install the print cartridge.

Figure 6.10 Cleaning Electrical Contacts

Print a Nozzle Pattern Diagnostic Test

- 1 Hold down the Power Button while pressing the Cancel Button eight times and the Resume Button four times.
- 2 Release the Power Button. The printer prints a Nozzle Pattern test.

Pen Recovery Diagnostic Test

See *Pen Recovery Diagnostic Test* on page 6-63.

Change the Print Cartridges

Both print cartridges are installed in the same manner. If you believe your print cartridges are running out of ink prematurely, see *Short Print Cartridge Life* on page 6-53.

Note

When you install a new cartridge, the printer automatically aligns the cartridges by printing a page. Make sure your printer has a sheet of standard paper available to perform the alignment. If you replace a cartridge during a print job, alignment occurs after the print job is finished.

- 1 Power on the printer and open the Access Door. The Carriage will move to the center of the printer.
- 2 Flip up the print cartridge latch, grasp the top of the old print cartridge, and pull it up and out of its cradle.

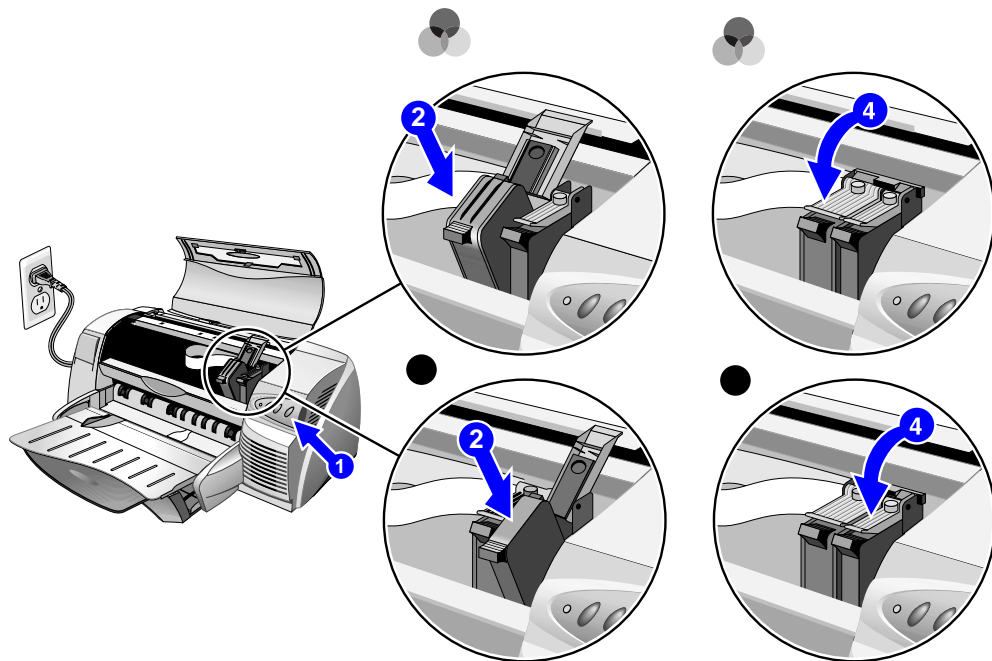

Figure 6.11 Changing Print Cartridges

- 3 Remove the new print cartridge from its package, and without touching the ink nozzles or the contacts, gently remove the tape covering the ink nozzles.

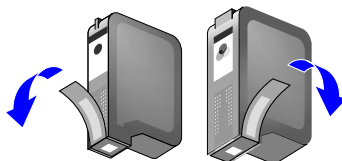

Figure 6.12 Removing Protective Tape from Ink Nozzles

- 4 Push the new cartridge down firmly into its cradle slot, and close the print cartridge latch.
- 5 Close the Access Door.

Note

If you did not install a recommended print cartridge, or the print cartridge is not properly installed, the Carriage will return to the loading position, and the Print Cartridge Light will continue to blink.

Replacement of Parts

To replace the Carriage PCA, see page 7-28.

To replace the Service Station, see page 7-19.

To replace the Logic PCA, see page 7-10.

To replace the Flex Cable, see page 7-28.

Short Print Cartridge Life

Table 6.10 Short Print Cartridge Life

Possible Causes	Explanation
Higher coverage rate than listed in the specifications	Heavy concentrations of ink significantly reduce the number of pages a print cartridge can handle.
Pages contain graphics	Printing graphics requires much more ink than printing text. Whenever possible, print draft copies without the graphics.
Selected print mode	Best and Normal print modes use more ink than EconoFast mode. To maximize print cartridge life, print drafts of documents in EconoFast mode.
Print cartridge has passed expiration date	The print cartridge has passed its 18-month shelf life. Replace the print cartridge. Use a FIFO (First In-First Out) inventory process to avoid having expired print cartridges in stock.
Printer is unplugged with the print cartridge out of its home position	If you unplug the power cord to turn off the printer, the Carriage does not return to the home position. Always power off the printer by pressing the Power Button. This returns the print cartridges to the home position where the Service Station caps the print cartridge nozzles to minimize ink drying.

Table 6.10 Short Print Cartridge Life

Print cartridge may need to be restored	Restore the print cartridge by running the cleaning routine. If print quality is not restored, replace the print cartridge.
Excessive use of the print cartridge cleaning routine	Restoring print cartridges by running the cleaning routine consumes ink. Avoid excessive use of the cleaning routine.
Print cartridge stored improperly.	Open print cartridges must be stored in the printer or in a print cartridge storage container.
Refilled print cartridge	Hewlett-Packard does not recommend or guarantee the print quality or print cartridge life of refilled print cartridges. Replace the print cartridge with a new HP print cartridge.
Incorrect estimate of pages printed with the print cartridge	It is very easy to underestimate the number of pages printed. When counting pages per cartridge, be sure to count drafts that are thrown away.
Faulty print cartridge	Replace the print cartridge. If a pattern of faulty cartridges develops, the printer may be causing the print cartridges to fail. In this case, replace the Logic PCA.
Printer hardware problem	The Service Station may be faulty, or the printer may be damaging the print cartridges. If the problem recurs, replace the Service Station components or the Logic PCA.

Troubleshooting Paper Eject Problems

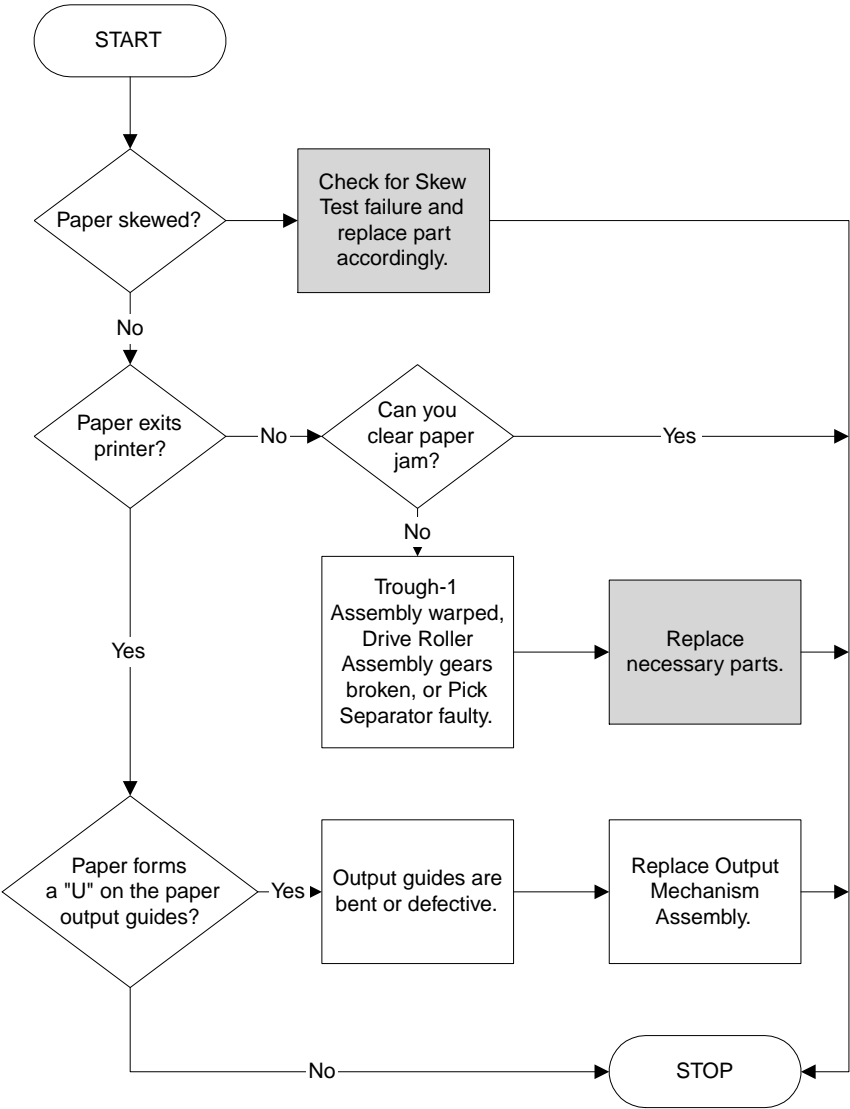

Tree 6.11 Troubleshooting Paper Eject Problems

Skew Test

The HP DeskJet 1220C Software Diagnostic Test Program includes a skew test. For information on installing and using the diagnostic test program, see page 6-72.

Replacement of Parts

Check to see if the plate on the Trough-1 Assembly is warped. To replace the Trough-1 Assembly, see page 7-32.

To replace the Drive Roller Assembly, see page 7-31.

To replace the Pick Separator Assembly, see page 7-36.

To replace the Output Mechanism Assembly, see page 7-22.

Troubleshooting Unusual Noises

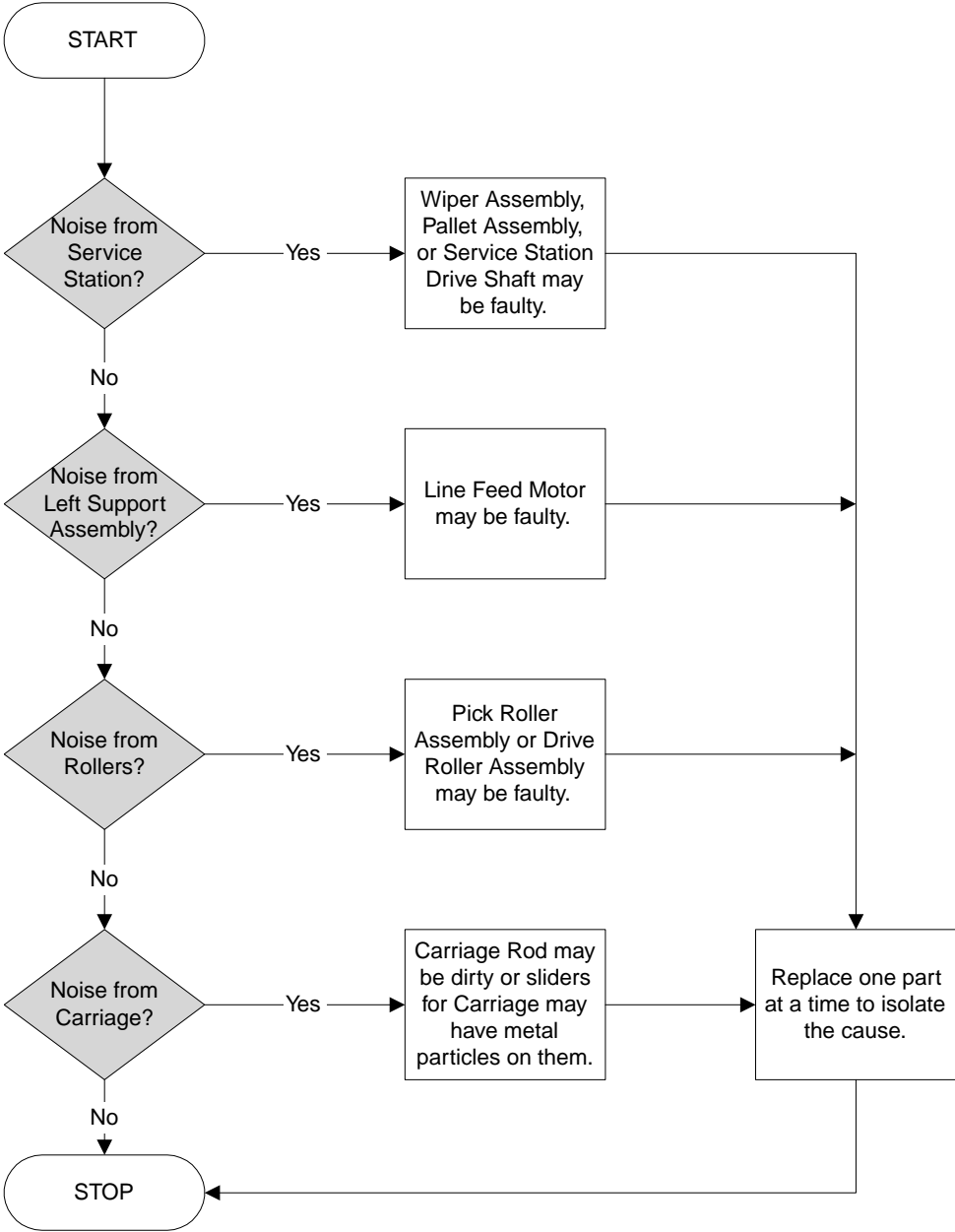

Tree 6.12 Troubleshooting Unusual Noises

Noise from the Service Station?

To replace the Wiper Assembly, see page 7-35.

If the Pallet Assembly or Service Station Drive Shaft are faulty, replace the Service Station. To replace the Service Station, see page 7-19.

Noise from the Left Support Assembly?

If the Line Feed Motor is faulty, replace the Left Support Assembly. For removal instructions, see page 7-34.

Noise from the Rollers?

Both the Pick Roller Assembly and Drive Roller Assembly have rollers responsible for feeding the paper in to the printer.

To replace the Pick Roller Assembly, see page 7-25.

To replace the Drive Roller Assembly, see page 7-31.

Noise from the Carriage?

Check the Carriage Rod for dirt particles.

To check the sliders on the Carriage, you must remove the Carriage. For instructions on removing the Carriage, see page 7-27.

Diagnostic Tools

Self-Test

This test verifies that the printer is connected to the computer properly and that the printer and printer software are working properly. If the Self-Test page does not print out, then there may be a problem with the printer configuration. The Self-Test also provides useful information for troubleshooting print quality and print cartridge problems.

- 1 Open the ToolBox by double-clicking the HP 1220C icon on your desktop or click **Start**, select **Programs**, followed by “**HP 1220C Series**”, followed by HP 1220C ToolBox.

- 2 Select **Printer Services** and click **Print a Self-Test Page**.

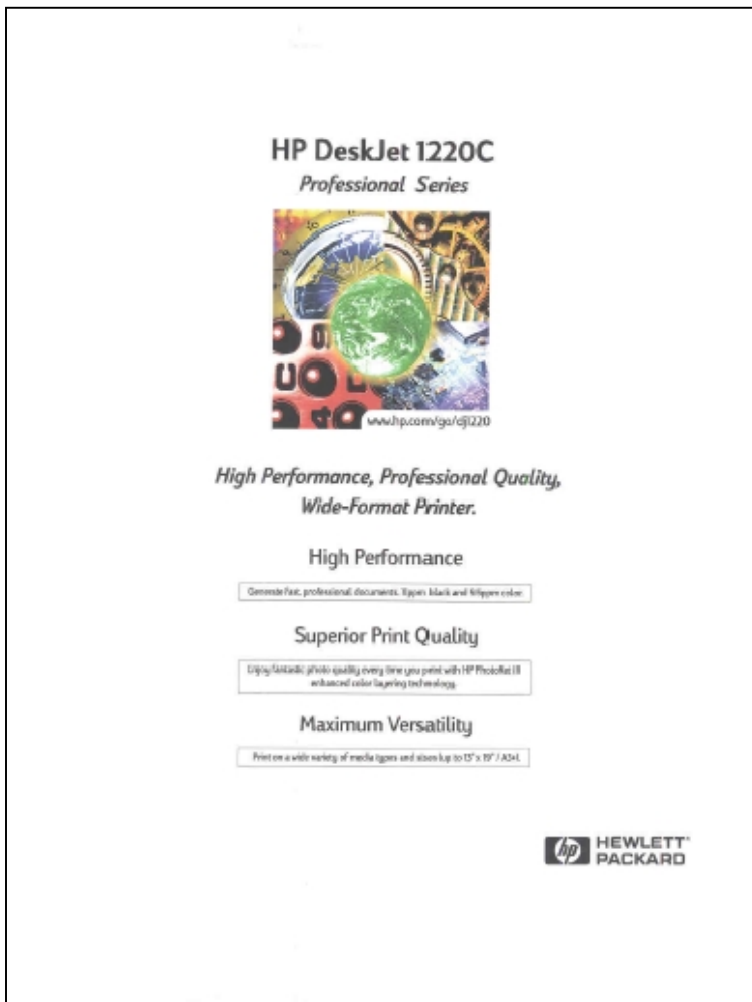

Figure 6.13 Self-Test Page

Sample Page

Print a Sample page without being connected to a computer. This allows you to see that your printer is set up correctly.

- 1 Turn off the printer, and then turn it on again by pressing the Power Button.
- 2 Press the Resume Button and release it when the Resume Light turns off. Your printer prints a Sample page.

Note

The printout for the Sample page and the Self-Test is the same. See *Self-Test* above for an example of the printout.

Single Diagnostic Test

- 1 Power on the printer.
- 2 Press and hold the Power Button and press the Resume Button four times.
- 3 Release the Power Button. The printer prints a Single Diagnostic Test.

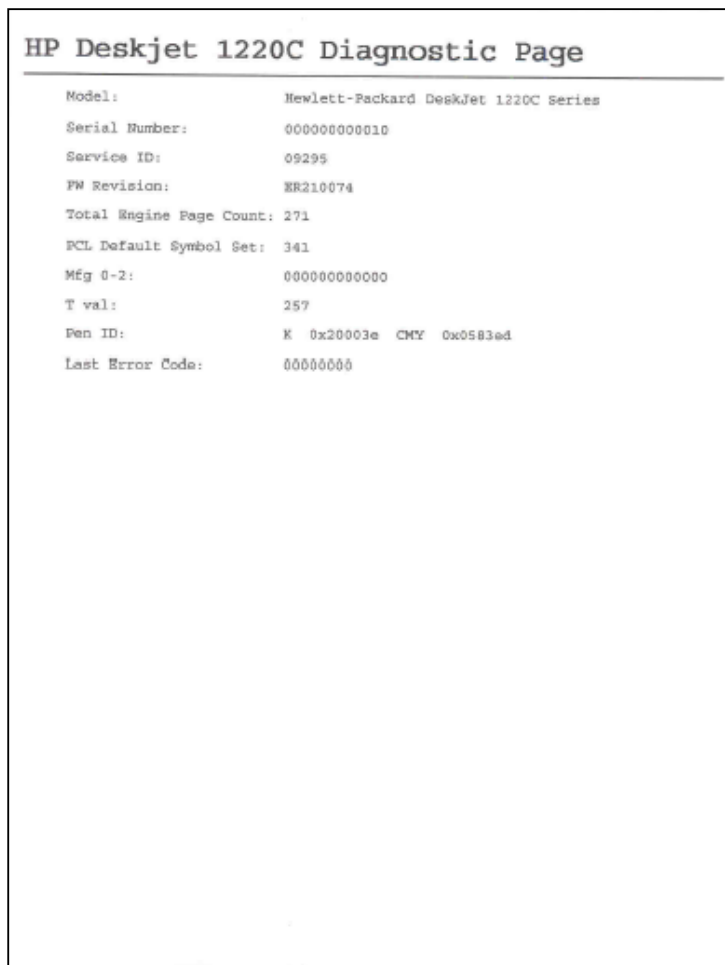

Figure 6.14 Single Diagnostic Test Page

The Diagnostic Test printout contains the following information:

- Printer Model
- Serial Number
- Born-On Date (Service ID)—See below for more information.

- Firmware Revision
- Print Total Engine Page Count
- PCL Default Symbol Set–(For example, the code for the US fonts set is 341.)
- Manufacturing Tracking Code–(This information has no value for field repair.)
- Error Code–If an error code (hex) number is displayed, it represents the last error that occurred regardless of whether the problem that caused the error has been fixed and the printer is presently operational.

Born-On Date

The Born-On Date (BOD), or Service ID, is automatically set when the first document is printed following the installation of the printer driver software. The BOD can be used to determine if the product is under warranty.

The BOD is saved as a five digit code, YYDDD, where YY equals the number of years after 1990 and DDD equal the day of the year. For example, 09245 is the 245th day of 1999 or, September 2, 1999. Therefore the warranty period began on September 2, 1999. Provide a six day grace period when determining if the printer is under warranty; this will allow for exceptions such as leap year calculations and manual calculation errors.

Note

The Born-On Date is also valuable for identifying the printer usage rate. The Diagnostic Test identifies the total pages printed by the printer (Print Engine Total Page Count). Therefore you can determine the usage rate by identifying the page count per length of time: [page count / (current date – Born-On Date)]. Remember, the Reliability and Estimated Usage specification for the printer is 5,000 pages per month.

Nozzle Pattern Diagnostic Test

This test prints a pattern to determine which nozzles, if any, are clogged or not firing. Look for gaps in the test pattern; these indicate faulty nozzles.

- 1 Hold down the Power Button while pressing the Cancel Button eight times and the Resume Button four times.

- 2 Release the Power Button. The printer prints a Nozzle Pattern test.



Figure 6.15 Nozzle Pattern Diagnostic Test Page

Pen Recovery Diagnostic Test

If printouts have incomplete text or graphics that are not corrected by cleaning the print cartridges, use the Pen Recovery Diagnostic Test. The Pen Recovery Diagnostic Test is a three level cleaning procedure that attempts to clean blocked print cartridge nozzles.

Level One

Level One performs a light print cartridge cleaning.

- 1 Hold down the Power Button while pressing the Cancel Button twice.
- 2 Release the Power Button.

- 3 Run the Nozzle Pattern Diagnostic Test (see page 6-62). Look for gaps in the Nozzle Pattern test. If no gaps are present, the print cartridge has recovered. If gaps appear, run Level Two of the Pen Recovery test.

Level Two

Level Two performs an intermediate cleaning routine.

Note

Do not use this Pen Recovery test unnecessarily. This test shortens the life of the print cartridges.

- 1 Hold down the Power Button while pressing the Cancel Button twice and the Resume Button once.
- 2 Release the Power Button.
- 3 Run the Print Cartridge Nozzle Test. Look for gaps in the Nozzle Pattern test. If no gaps are present, the print cartridge is recovered. If gaps appear, run Level Three of the Pen Recovery test.

Level Three

Level Three performs an intensive cleaning routine that takes about 2 minutes to complete.

- 1 Hold down the Power Button while pressing the Cancel Button twice and the Resume Button twice.
- 2 Release the Power Button.
- 3 Run the Print Cartridge Nozzle Test. Look for gaps in the Nozzle Pattern test. If no gaps are present, the print cartridge is recovered. If gaps appear, replace the print cartridge.

Note

Use this test as the last resort for recovering clogged print cartridge; it consumes a considerable amount of ink.

Calibration Diagnostic Test

This test calibrates the print cartridges by aligning the cartridges, as well as optimizing the turn-on energy for the color print cartridge.

- 1 Hold down the Power Button while pressing the Resume Button three times.

- 2 Release the Power Button. The printer prints a Calibration Diagnostic test page.

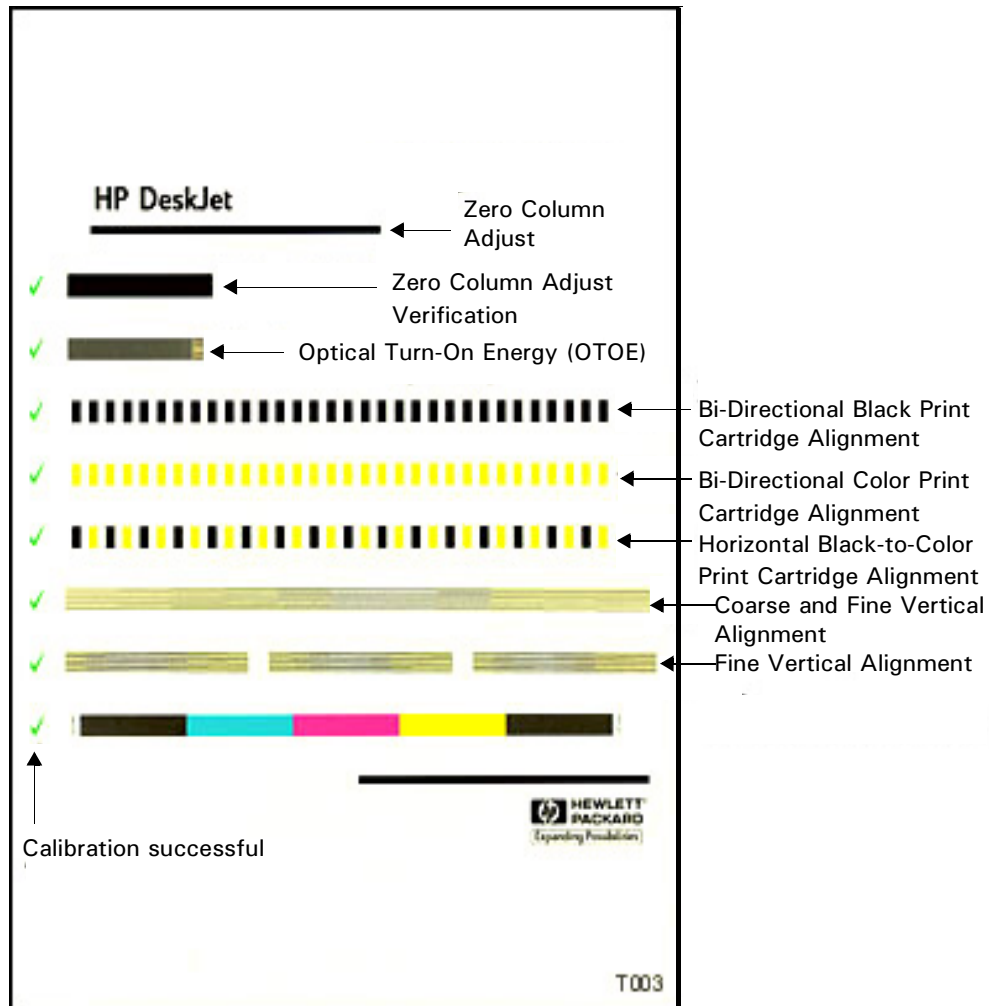

Figure 6.16 Calibration Diagnostic Test Page

A green check mark to the left of each test, indicates that calibration was successful. For the numeric values associated with each test, print the Extended Diagnostic Test (see page 6-66).

- **Zero Column Adjust**—The printer prints a black bar and scans across the bar to the edges of the paper to calibrate the print cartridge tolerance from the home position.
- **Optical Turn-On Energy (OTOE)**—For maximum print cartridge reliability the color print cartridge must operate at the minimum amount of energy needed to fire all the nozzles. The OTOE test prints a series of rectangles and then scans the rectangular pattern to determine the lowest energy level

at which all nozzles fire. To determine the OTOE numeric value, print the Extended Diagnostic Test (see page 6-66) or print the OTOE Decoder document on a transparency.

- Bi-Directional Print Cartridge Alignment—Calibrates the printing alignment of bi-directional carriage movement.
- Coarse and Fine Vertical Alignment—Calibrates the vertical alignment between the black and color print cartridges.

Extended Diagnostic Test

This test identifies printer values stored in the non-volatile random access memory (NVRAM). For example, numbers include the OTOE and print cartridge alignment values.

- 1 Press and hold the Power Button while pressing the Cancel Button once and the Resume Button twice.
- 2 Release the Power button. The printer prints an Extended Diagnostic Test page.

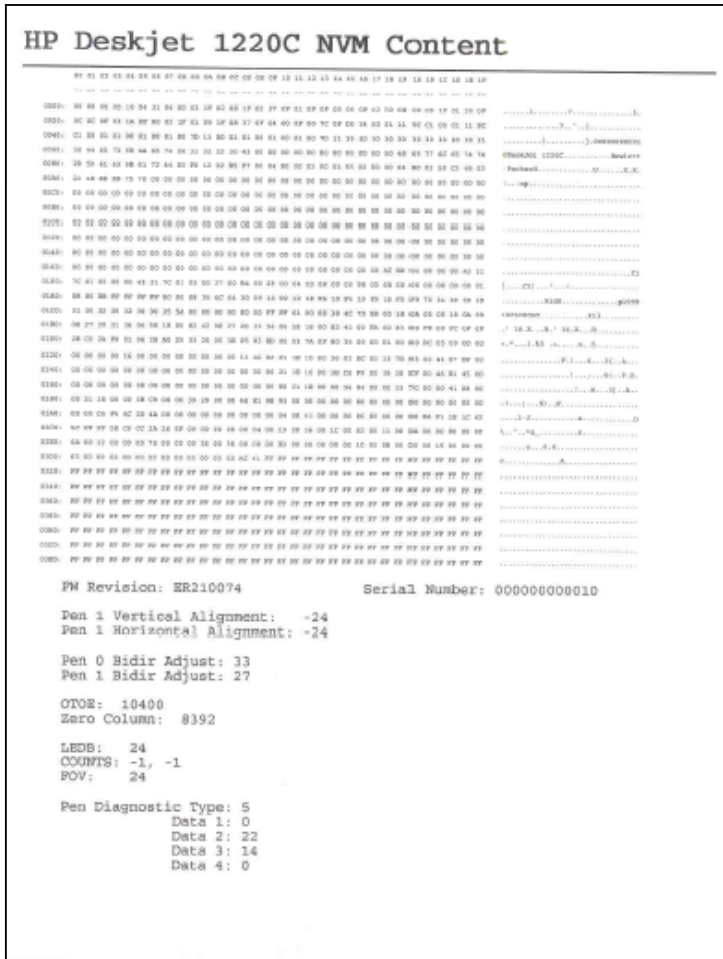

Figure 6.17 Extended Diagnostic Test Page

Dot Count Diagnostic Test

This test identifies the status of the current black and color print cartridges and the previous black and color cartridges.

- 1 Press and hold the Power Button while pressing the Cancel Button four times and the Resume Button once.
- 2 Release the Power Button. The printer prints a Dot Count Diagnostic Test page.

```

HP Deskjet 1220C Dot Count
-----
Raw IDs:
-----
Current:   I. 0x20003e   II. 0x0583ed
Previous:  I. 0x00037a   II. 0x0f8035

R10X Values for [I]:
-----
Current:           209           Previous:           220

Absolute Totals:
-----
Current:   I.   5408861           Previous:   I.           0
           IIA.  9511934           IIA.           0
           IIB.  9311891           IIB.           0
           IIC. 11411831           IIC.           0

Modulated Totals:
-----
Current:   I.   5408861           Previous:   I.           0
           IIA. 11218217           IIA.           0
           IIB. 11012139           IIB.           0
           IIC. 13130496           IIC.           0

Global Totals (multiply by 256):
-----
Absolute:  I.       21129           Modulated:  I.       21129
           IIA.    37156           IIA.    43821
           IIB.    36375           IIB.    43016
           IIC.    44577           IIC.    51322

Trigger Table Data      I           II
-----
Total Available:      898000000   1095850000
Trigger 1:            898000000   1095850000
Trigger 2:            1103000000   1489000000
Trigger 3:            1236000000   1742640000
Trigger Level:         0           0

Remaining Quantities:
-----
   I. 100 percent
   II. 99 percent

Total Engine Page Count: 276
FW Revision: ER210074           Serial Number: 000000000010

```

Figure 6.18 Dot Count Diagnostic Test Page

The Dot Count Diagnostic Test page includes:

- Raw IDs—The identification number for each print cartridge.
- Global Totals—The number of dots fired for each print cartridge.
- Remaining Quantities—Percentage of ink remaining in the current black and color print cartridges.

Pen ID Diagnostic Test

This test gives the identification number of the current print cartridges.

- 1 Press and hold the Power Button while pressing the Cancel Button four times and the Resume Button twice.
- 2 Release the Power Button. The printer prints a Pen ID Diagnostic Test page.



Figure 6.19 Pen ID Diagnostic Test Page

Infinite Hs Diagnostic Test

Use the Infinite HS Test when you need to test or repair a printer in a constant printing situation.

- 1 Press and hold the Power Button while pressing the Resume Button eight times.
- 2 Release the Power Button. The printer continuously prints Infinite Hs Diagnostic Test pages.

- 3 Power off the printer to end the Infinite Hs Diagnostic Test.

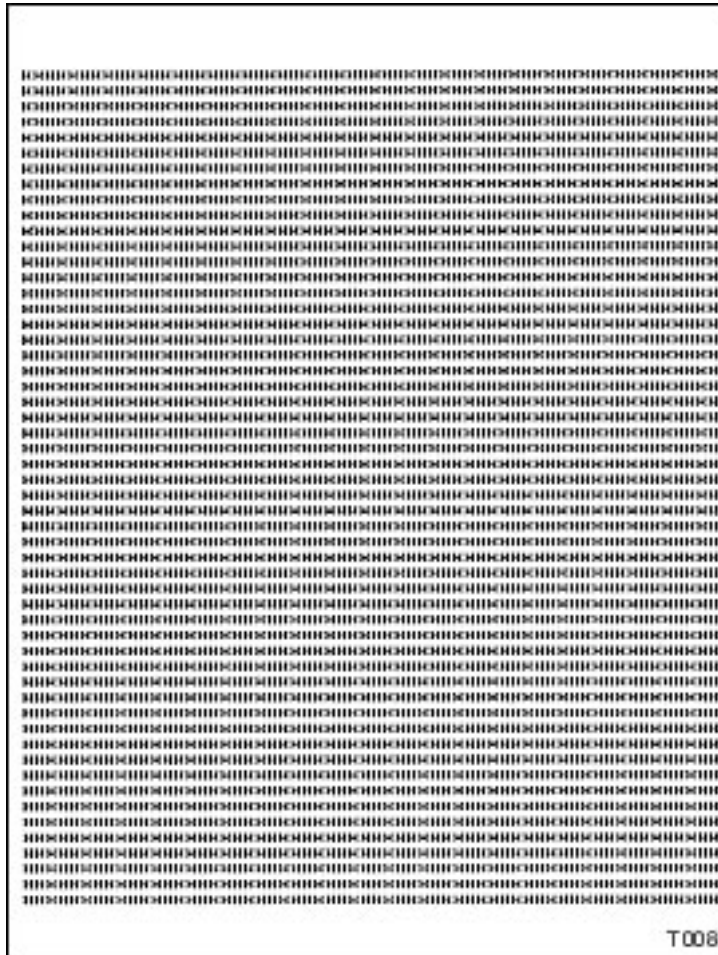

Figure 6.20 Infinite Hs Diagnostic Test Page

Page Alignment Diagnostic Test

This test aligns the print cartridges.

Note

The same alignment procedure is performed by the Calibration Diagnostic Test.

- 1 Press and hold the Power Button while pressing the Cancel Button three times.
- 2 Release the Power Button. The printer prints a Page Alignment Diagnostic Test.

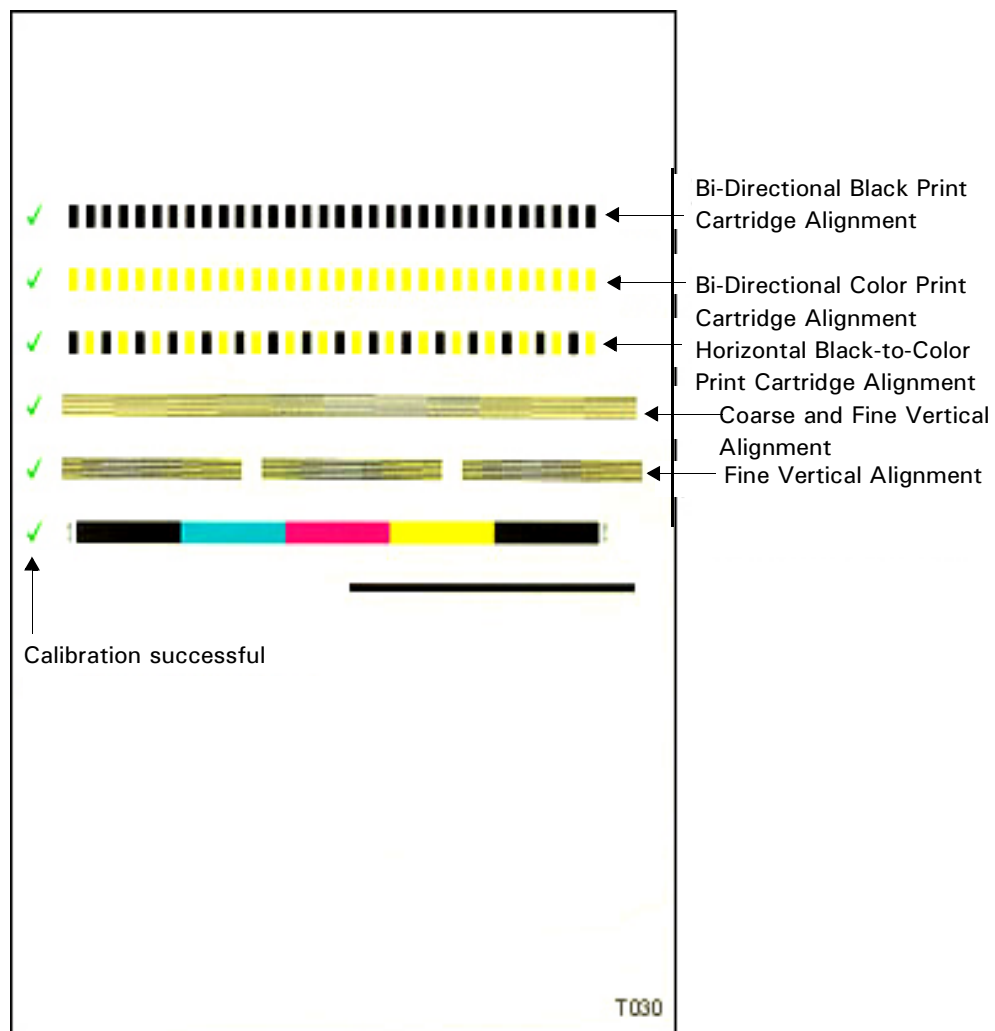

Figure 6.21 Page Alignment Diagnostic Test Page

A green check mark to the left of each test, indicates that calibration was successful. For the numeric values associated with each test, print the Extended Diagnostic Test (see page 6-66).

- Bi-Directional Print Cartridge Alignment—Calibrates the printing alignment of bi-directional carriage movement.
- Coarse and Fine Vertical Alignment—Calibrates the vertical alignment between the black and color print cartridges.

DeskJet 1220C Software Diagnostic Test Program

The DeskJet 1220C Software Diagnostic Test Program performs the following functions:

- **Print Final Test Page**—Prints two final test pages.
- **Reset NVRAM**—Resets the printer NVRAM. This will reset the page count to zero. If you changed the Logic PCA, you will be prompted to key in the printer's serial number. Note the last two digits of the serial number are keyed in but not displayed.
- **Firmware Version**—Identifies the printer firmware version.
- **Carriage Test**—Performs a functional test of the Carriage.
- **Service Station Test**—Performs a functional test of the Service Station.
- **Cancel Printer I/O**—Disables the printer I/O. This option is located in a separate window.

To install the DeskJet 1220C Software Diagnostic Test Program:

- 1 Create a folder, for example, c:\1220C.
- 2 Unzip escherNT.zip to this folder. It should contain seven files: escherNT.exe, hpfcom15.dll, mine2.pcl, spooler.bat, starts.bat, vcommapi.zip, and vs.dll.
- 3 Open the folder and unzip vcommapi.exe.
- 4 Install vcommapi.exe and restart your computer.
- 5 Copy the files Hpfcom15.dll and Vs.dll to c:\winNT\system32.
- 6 Double-click escherNT.exe to run the program. The HP 1220C Diagnostic Test and the Cancel Printer I/O windows will appear.

Removal, Replacement, and Calibration

Removal and Replacement Strategy	7-2
Removal and Replacement Tools.....	7-2
Before You Begin	7-2
Tips for Disassembling the Printer	7-3
Disassembly Sequence	7-4
Consumer Removable Parts.....	7-5
Output Tray	7-5
Stopper Assembly.....	7-5
Cleanout Trough Assembly	7-6
Parts Serviceable without Calibration	7-7
Stopper Guides.....	7-7
Rubber Feet	7-8
Access Door Assembly	7-8
Logic PCA Assembly	7-9
Left End Cap Assembly	7-10
Power Supply Assembly	7-11
Power Insulator	7-12
Right End Cap Assembly.....	7-12
Keypanel PCA	7-13
Main Logic Harness Assembly	7-13
Power Switch Harness	7-14
Hand Grabs.....	7-14
Linefeed/Encoder PCA	7-14
Encoder Disk Assembly	7-15
Output Belt	7-15
Encoder Strip	7-16
Carriage Motor Assembly.....	7-17
Service Station Mechanism Assembly	7-18
Spot Sensor Assembly	7-18
Pivot Spring and Rocker Plate Spring.....	7-19
Rail Cover	7-20
Starwheels Assembly	7-20
Output Mechanism Assembly	7-21
Output Motor Assembly	7-22
Input Tray Assembly	7-22
Pick Roller Assembly	7-24

Serviceable Parts that Require Calibration	7-26
Carriage Assembly/Carriage Rod	7-26
Flex Cable.....	7-27
Backbone Assembly	7-28
Upper Paper Guide Assembly	7-28
Drive Roller Assembly	7-30
Trough-1 Assembly	7-31
Right Support Assembly	7-32
Left Support Assembly	7-33
Base Plate Assembly	7-33
Removal of Subassembly Parts	7-34
Calibrating the Printer.....	7-36
Calibration Tool	7-36
How to Calibrate	7-36

Removal and Replacement Strategy

This chapter describes how to disassemble the HP DeskJet 1220C printer. To service certain parts of the printer, it may not be necessary to completely disassemble the printer. However, it is important to remove parts in the proper order; for details on the order of removal, see the *Disassembly Sequence*.

To reassemble the printer, repeat the steps in reverse order.

Note

Additional instructions for difficult or critical reassembly procedures are included.

Removal and Replacement Tools

You will need the following tools to disassemble the printer:

- TORX[®] screwdriver with T-08, T-10, and T-20 screw bits or T-08, T-10 and T-20 TORX[®] screwdrivers. A magnetized screwdriver is helpful.
- Needle nose pliers.
- Small flathead screwdriver.

Before You Begin

Before you begin to disassemble the printer:

- 1 Remove paper from the Input Tray.
- 2 Remove print cartridges from the Carriage. To prevent ink from becoming encrusted on the print nozzles, place each print cartridge in a paper envelope and then seal it in a plastic bag.
- 3 Power off the printer, remove the power cord, and wait at least five seconds.

WARNING!

To avoid electrical shock, completely discharge the capacitors before handling power supply components. To do this, power off the printer before you unplug the power cord. Wait five seconds before disassembling the printer.

Tips for Disassembling the Printer

- Many parts of the printer use plastic snap-fit technology. Use care when removing these parts; excessive force could break the snaps off of the parts.
- Use the correct screws when reassembling the printer.

Caution

Electrostatic discharge (ESD) from your body can damage the Printer Circuit Assemblies (PCAs). Before removing any PCA, ensure that your work area is static-free; wear ESD dissipative straps, use an ESD mat, or work at an ESD protected workstation.

Disassembly Sequence

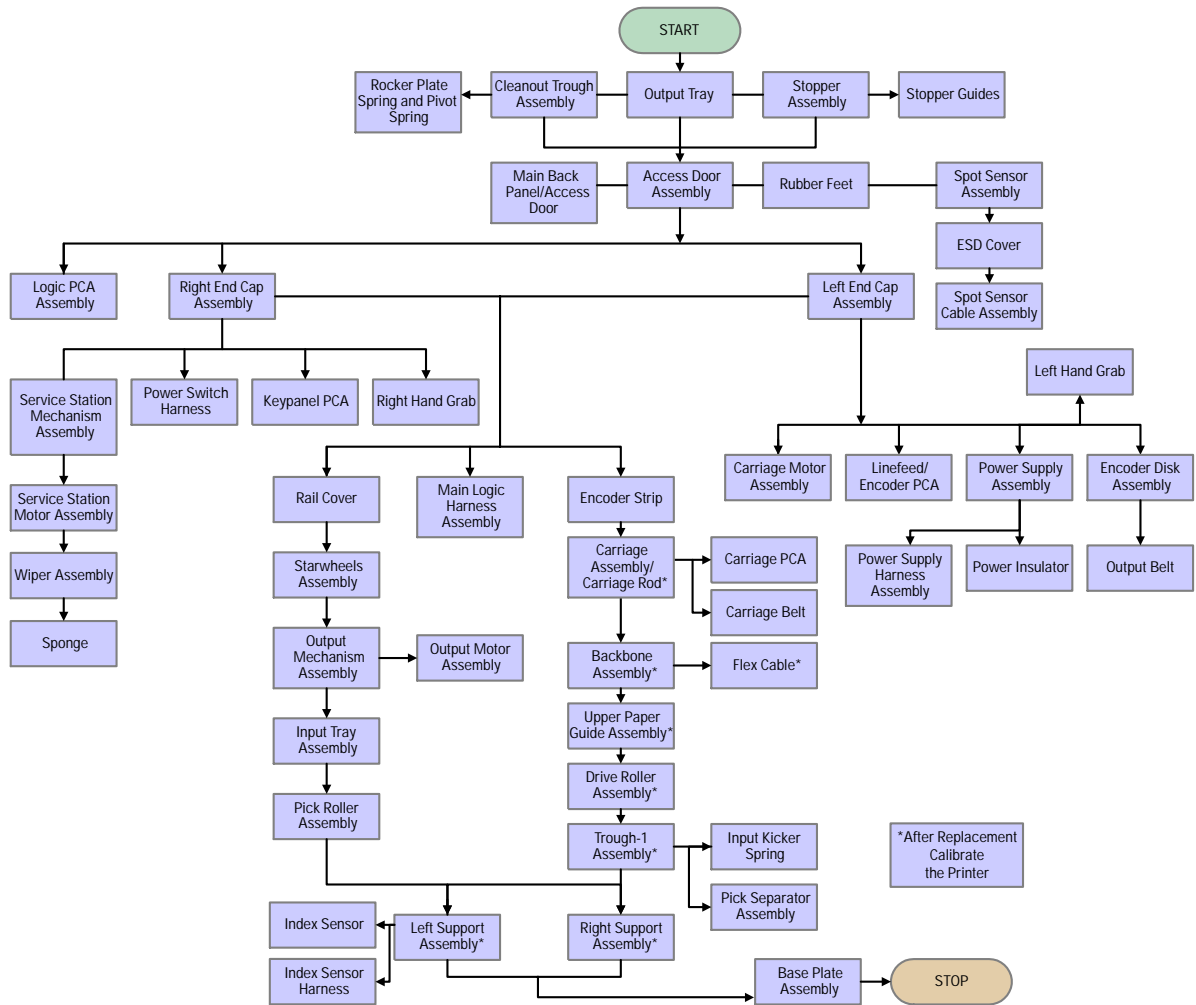

Tree 7.1 Disassembly Sequence

Consumer Removable Parts

The following parts are Service Level 1 parts; they can be removed and replaced by the user and no tools are required to service these parts.

Output Tray

- 1 Lift up tray (see number one in illustration below).
- 2 Pull straight up to remove.

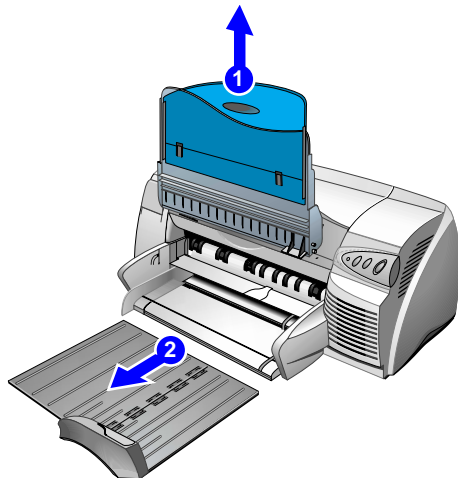
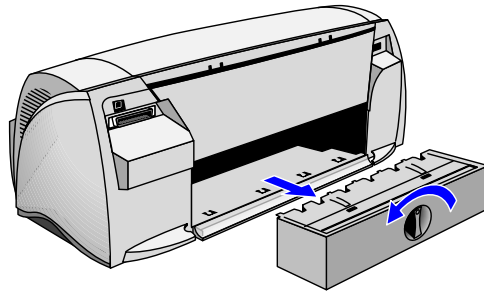

Figure 7.1 Removing the Output Tray and Stopper Assembly

Stopper Assembly

- 1 Fully extend the Stopper Assembly (see number two in illustration above).
- 2 Pull the Stopper Assembly slightly upwards and remove.

Cleanout Trough Assembly



- 1 Turn the printer around to access the Cleanout Trough Assembly on the back of the printer.
- 2 To unlock panel, turn knob counterclockwise.
- 3 Pull panel straight out to remove.

Figure 7.2 Removing the Cleanout Trough Assembly

Note

The Cleanout Trough Assembly must be locked in place for the printer to print. If the Cleanout Trough is left in the unlocked position, the printer will power off.

For instructions on further disassembly of the Cleanout Trough Assembly, see *Removal of Subassembly Parts* on page 7-35.

Parts Serviceable without Calibration

The following parts are Service Level 2 parts. They are serviceable by authorized service providers or HP Technical Support using the common tools listed in *Removal and Replacement Tools* on page 7-3. These parts can be removed and replaced without calibrating the printer.

Stopper Guides

First remove the following:

- 1 Cleanout Trough Assembly
- 2 Stopper Assembly
- 3 Output Tray

- 1 Place the printer on its back. From this position, you can see the Stopper Guides on the Base Plate.

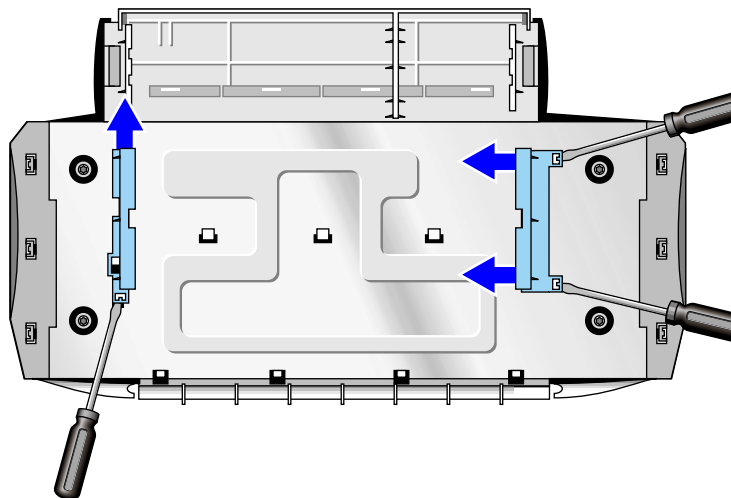

Figure 7.3 Removing the Stopper Guides

- 2 For the left Stopper Guide, use a small flathead screw driver to lift up and release the catch. To remove, slide the guide towards the front of the printer.
- 3 For the right Stopper Guide, use a flathead screwdriver to lift up and release the top catch. Slide the top of the Stopper Guide toward the center of the printer. Repeat for the bottom catch.

Rubber Feet

First remove the following:

- 1 Cleanout Trough Assembly
- 2 Stopper Assembly
- 3 Output Tray

- 1 Turn the printer over so you can see the Stopper Guides on the Base Plate.
- 2 For each Rubber Foot, remove the screw and pull the foot off the Base Plate.

Access Door Assembly

First remove the following:

- 1 Cleanout Trough Assembly
- 2 Stopper Assembly
- 3 Output Tray

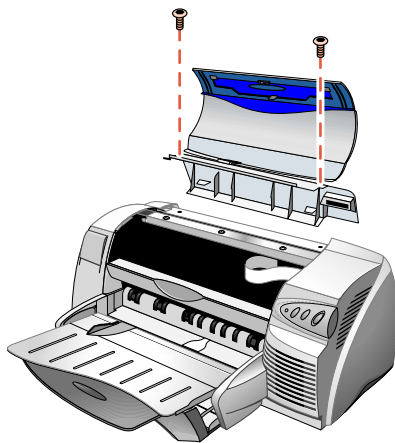

- 1 Facing the front of the printer, lift up the Access Door to expose the inside of printer.
- 2 Remove the two T-20 screws that connect the Access Door Assembly to the Right Support Assembly and the Left Support Assembly.
- 3 Lift assembly straight up; be careful of the catch on the right side.

Figure 7.4 Removing the Access Door Assembly

For instructions on further disassembling the Access Door Assembly, see *Removal of Subassembly Parts* on page 7-35.

Logic PCA Assembly

First remove the following:

- | | |
|----------------------------|------------------------|
| 1 Cleanout Trough Assembly | 3 Output Tray |
| 2 Stopper Assembly | 4 Access Door Assembly |

- 1 Turn the printer around so you are facing the back of the printer.

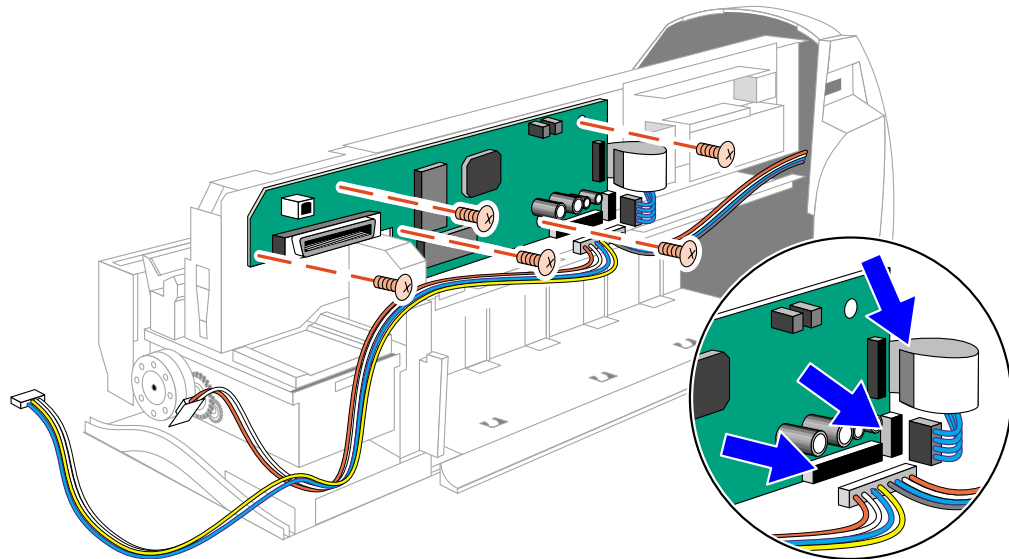

Figure 7.5 Removing the Logic PCA Assembly

- 2 Grasp the Flex Cable and gently pull to remove it from the Logic PCA Assembly.
- 3 Unplug the Main Logic Harness Assembly and the Power Supply Harness Assembly.
- 4 Remove the five T-10 screws that secure the Logic PCA Assembly to the Backbone Assembly.
- 5 Pull the PCA slightly toward you and lift upward to remove. You will need to lift the Right Case slightly to remove the Logic PCA Assembly.

Note

After replacing the Logic PCA Assembly with a new one, run the DeskJet 1220C Software Diagnostic Test to register the new Logic PCA. See *DeskJet 1220C Software Diagnostic Test Program* on page 6-72.

Left End Cap Assembly

First remove the following:

- | | |
|----------------------------|------------------------|
| 1 Cleanout Trough Assembly | 3 Output Tray |
| 2 Stopper Assembly | 4 Access Door Assembly |

- 1 Use a flathead screwdriver to release the two catches that secure the Left End Cap Assembly to the Input Tray Assembly.
- 2 From the bottom of the printer, use a flathead screwdriver to release the two catches that secure the Left End Cap Assembly to the Base Plate.

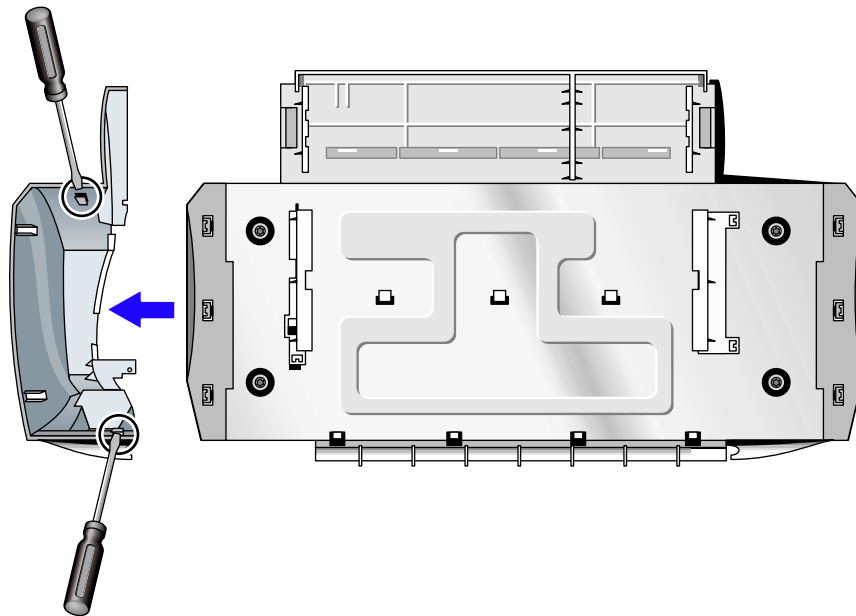

Figure 7.6 Removing the Left End Cap Assembly

- 3 Pull the Left End Cap Assembly outwards to remove.

Power Supply Assembly

First remove the following:

- | | |
|----------------------------|-------------------------|
| 1 Cleanout Trough Assembly | 3 Output Tray |
| 2 Stopper Assembly | 4 Access Door Assembly |
| | 5 Left End Cap Assembly |

- 1 Turn the printer around so you are facing the back of the printer.
- 2 Open the Power Insulator.

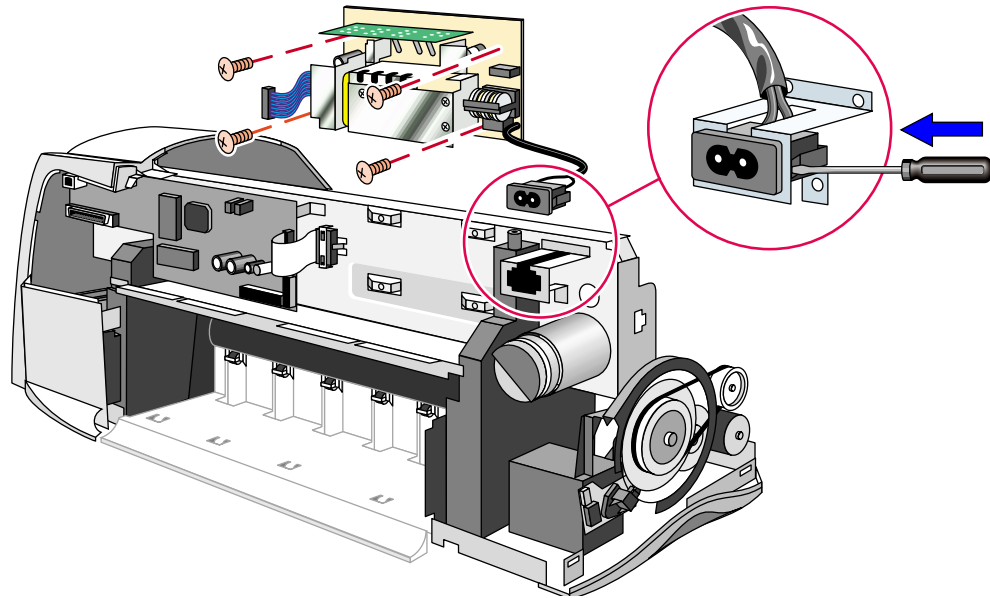

Figure 7.7 Removing the Power Supply Assembly

- 3 Use a flathead screwdriver to release the catches on both sides of the input power connector socket.
- 4 Remove the AC input plug from its bracket.
- 5 Remove the four T-10 screws that secure the Power Supply Assembly to the Backbone Assembly.
- 6 Disconnect the Power Switch Harness.
- 7 Remove the Power Supply Assembly with its AC input plug.

For instructions on further disassembling the Power Supply Assembly, see

Removal of Subassembly Parts on page 7-35.

Power Insulator

First remove the following:

- | | |
|----------------------------|-------------------------|
| 1 Cleanout Trough Assembly | 4 Access Door Assembly |
| 2 Stopper Assembly | 5 Left End Cap Assembly |
| 3 Output Tray | 6 Power Supply Assembly |

- 1 Release the four tabs.
- 2 Remove the Power Insulator from the Power Supply Assembly.

Right End Cap Assembly

First remove the following:

- | | |
|----------------------------|------------------------|
| 1 Cleanout Trough Assembly | 3 Output Tray |
| 2 Stopper Assembly | 4 Access Door Assembly |

- 1 Use a flathead screwdriver to release the catch that attaches the Right End Cap Assembly to the Input Tray.
- 2 Lift the printer slightly and gently remove the cover. At this point, the Right End Cap Assembly is still attached to the printer by two cables connected to the Keypanel PCA.

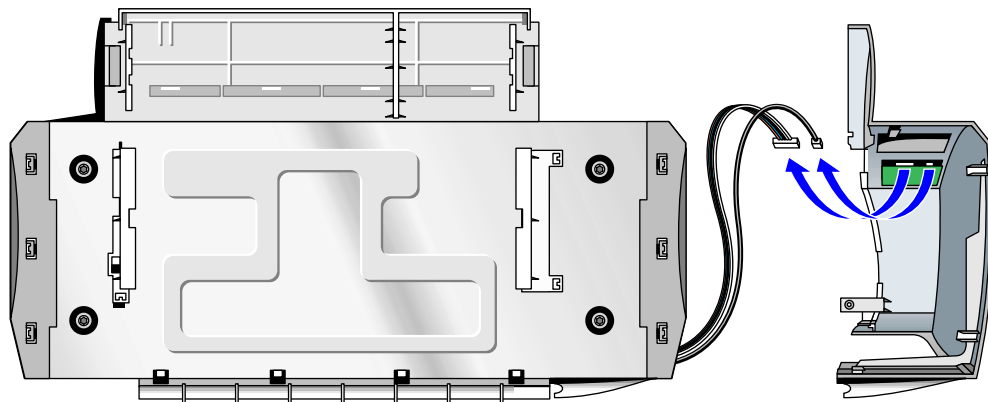

Figure 7.8 Removing the Right End Cap Assembly

- 3 Unplug the two connectors from the Keypanel PCA.

Keypanel PCA

First remove the following:

- | | |
|----------------------------|--------------------------|
| 1 Cleanout Trough Assembly | 3 Output Tray |
| 2 Stopper Assembly | 4 Access Door Assembly |
| | 5 Right End Cap Assembly |

- 1 Remove the two T-10 screws.

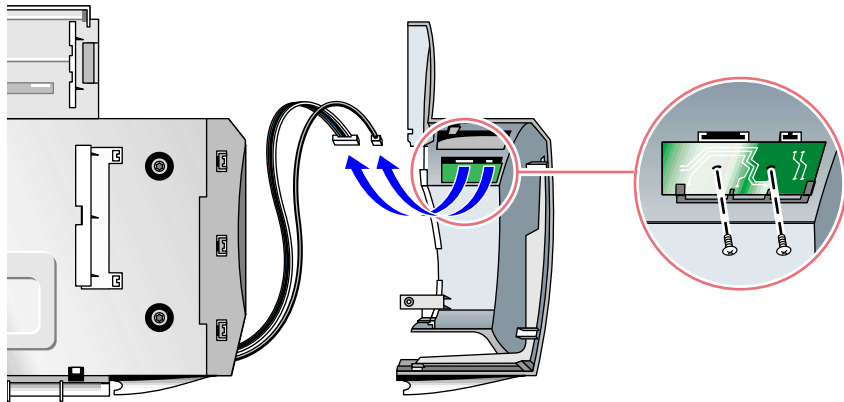

Figure 7.9 Removing the Keypanel PCA

Main Logic Harness Assembly

First remove the following:

- | | |
|----------------------------|--------------------------|
| 1 Cleanout Trough Assembly | 4 Access Door Assembly |
| 2 Stopper Assembly | 5 Right End Cap Assembly |
| 3 Output Tray | 6 Left End Cap Assembly |

- 1 Use needle nose pliers to remove the cable fasteners along the path.
- 2 Disconnect the Main Logic Harness Assembly from the following: Carriage Motor Assembly, Linefeed/Encoder PCA, Index Sensor, Output Motor, Line Feed Motor, and Service Station Motor.
- 3 Remove the Main Logic Harness Assembly.

Power Switch Harness

First remove the following:

- | | |
|----------------------------|--------------------------|
| 1 Cleanout Trough Assembly | 4 Access Door Assembly |
| 2 Stopper Assembly | 5 Right End Cap Assembly |
| 3 Output Tray | |

- 1 Turn the printer around so you are facing the back of the printer.
- 2 If still connected, disconnect the Power Switch Harness from the Power Supply Assembly and Keypanel PCA.
- 3 Use needle nose pliers to remove the cable fastener.
- 4 Remove the Power Switch Harness.

Hand Grabs

First remove the following:

- | | |
|----------------------------|--------------------------|
| 1 Cleanout Trough Assembly | 4 Access Door Assembly |
| 2 Stopper Assembly | 5 Right End Cap Assembly |
| 3 Output Tray | 6 Left End Cap Assembly |

- 1 On each side of the Base Plate, release the three catches and remove the Hand Grab.

Linefeed/Encoder PCA

First remove the following:

- | | |
|----------------------------|-------------------------|
| 1 Cleanout Trough Assembly | 4 Access Door Assembly |
| 2 Stopper Assembly | 5 Left End Cap Assembly |
| 3 Output Tray | |

- 1 Disconnect the Main Logic Harness Assembly from the Linefeed/Encoder PCA.
- 2 Remove the T-10 screw and the Encoder Guide.
- 3 Remove the Linefeed/Encoder PCA.

Encoder Disk Assembly

First remove the following:

- | | | | |
|---|--------------------------|---|-----------------------|
| 1 | Cleanout Trough Assembly | 4 | Access Door Assembly |
| 2 | Stopper Assembly | 5 | Left End Cap Assembly |
| 3 | Output Tray | | |

- 1 Gently pull on the Encoder Disk to remove.

Note

When you remove the Encoder Disk, always replace it with a new one. Do not reuse the Encoder Disk because the adhesive tape may no longer be effective.

Output Belt

First remove the following:

- | | | | |
|---|--------------------------|---|-----------------------|
| 1 | Cleanout Trough Assembly | 4 | Access Door Assembly |
| 2 | Stopper Assembly | 5 | Left End Cap Assembly |
| 3 | Output Tray | 6 | Encoder Disk Assembly |

- 1 Remove the Output Belt.

Encoder Strip

Caution

Do not touch the encoded parts of the strip. Always hold the Encoder Strip by the ends.

First remove the following:

- | | |
|----------------------------|--------------------------|
| 1 Cleanout Trough Assembly | 4 Access Door Assembly |
| 2 Stopper Assembly | 5 Left End Cap Assembly |
| 3 Output Tray | 6 Right End Cap Assembly |

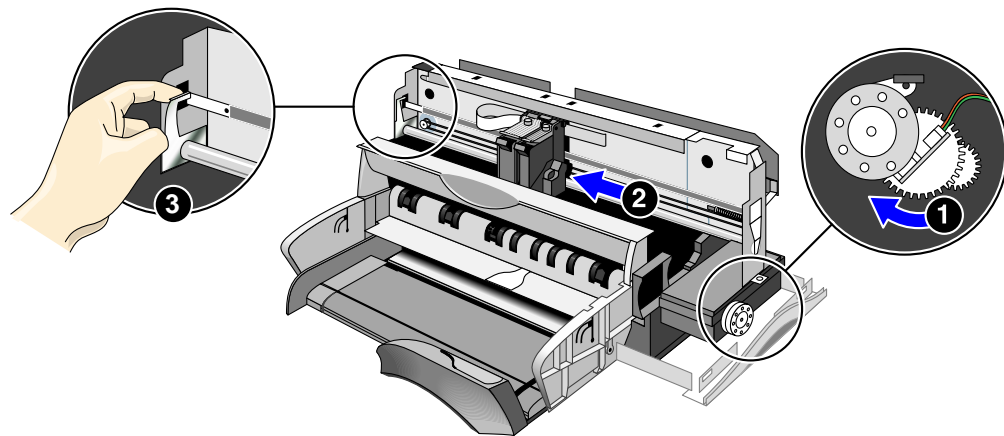

Figure 7.10 Removing the Encoder Strip

- 1 Locate the gear on the right side of the Service Station. To unlock the Carriage, turn the gear clockwise three revolutions.
- 2 Slide the Carriage to the middle of the printer.
- 3 To remove the left end of the Encoder Strip, push the spring (Encoder Spring) towards the center of the printer and unhook the Encoder Strip.
- 4 Release the hook on the right end of the Encoder Strip.
- 5 Slide the strip out of the Carriage and remove it from the printer.

Note

When reinstalling the Encoder Strip, attach one end and then, give the strip a 180° twist towards the back of the printer before hooking the other end in place. When properly reinstalled, the part number on the Encoder Strip faces the front of the printer.

Carriage Motor Assembly

First remove the following:

- 1 Cleanout Trough Assembly
- 2 Stopper Assembly
- 3 Output Tray
- 4 Access Door Assembly
- 5 Left End Cap Assembly

- 1 Disconnect the Main Logic Harness Assembly from the Carriage Motor Assembly.

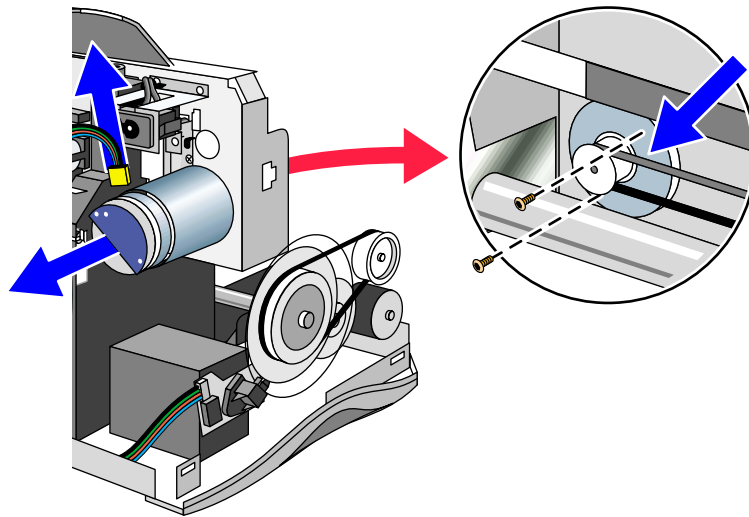

Figure 7.11 Removing the Carriage Motor Assembly

- 2 Unhook the Carriage Belt from the Carriage Motor Assembly.
 - a To release tension on the Carriage Belt, locate the lever on the back of the printer that operates the Turnaround Pulley.
 - b Push the lever towards the center of the printer and remove Carriage Belt.
- 3 Support the motor with your hand while you remove the two T-10 screws that attach the Carriage Motor Assembly to the Backbone Assembly.
- 4 Remove the Carriage Motor Assembly.

Service Station Mechanism Assembly

First remove the following:

- | | |
|----------------------------|--------------------------|
| 1 Cleanout Trough Assembly | 4 Access Door Assembly |
| 2 Stopper Assembly | 5 Right End Cap Assembly |
| 3 Output Tray | |

- 1 Remove the two T-10 screws; take care with the ESD clip.
- 2 Slide the Service Station Mechanism Assembly toward the back of the printer to remove.

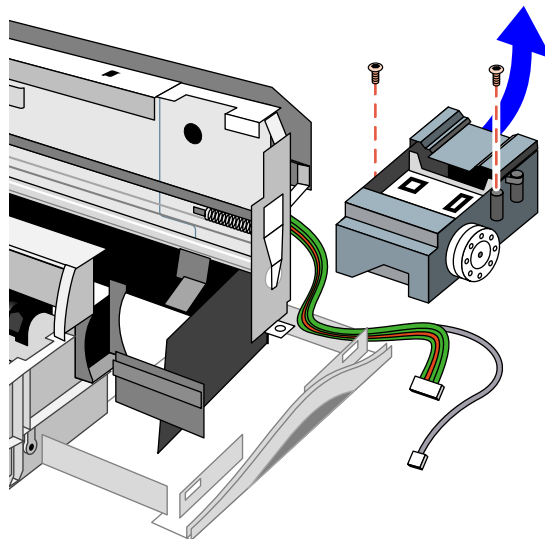

Figure 7.12 Removing the Service Station Mechanism Assembly

For instructions on further disassembly of the Service Station Mechanism Assembly, see *Removal of Subassembly Parts* on page 7-35.

Spot Sensor Assembly

First remove the following:

- | | |
|----------------------------|--------------------|
| 1 Cleanout Trough Assembly | 2 Stopper Assembly |
| | 3 Output Tray |

- 1 Remove the screw that attaches the Spot Sensor Assembly to the Carriage.

- 2 Remove the ESD Cover from the Spot Sensor.
- 3 Disconnect the Spot Sensor Cable Assembly from the Carriage and remove the Spot Sensor Assembly.
- 4 Disconnect the cable from the Spot Sensor.

Pivot Spring and Rocker Plate Spring

First remove the following:

- | | |
|----------------------------|------------------------|
| 1 Cleanout Trough Assembly | 3 Output Tray |
| 2 Stopper Assembly | 4 Access Door Assembly |

- 1 Turn the printer around so you are facing the back of the printer.

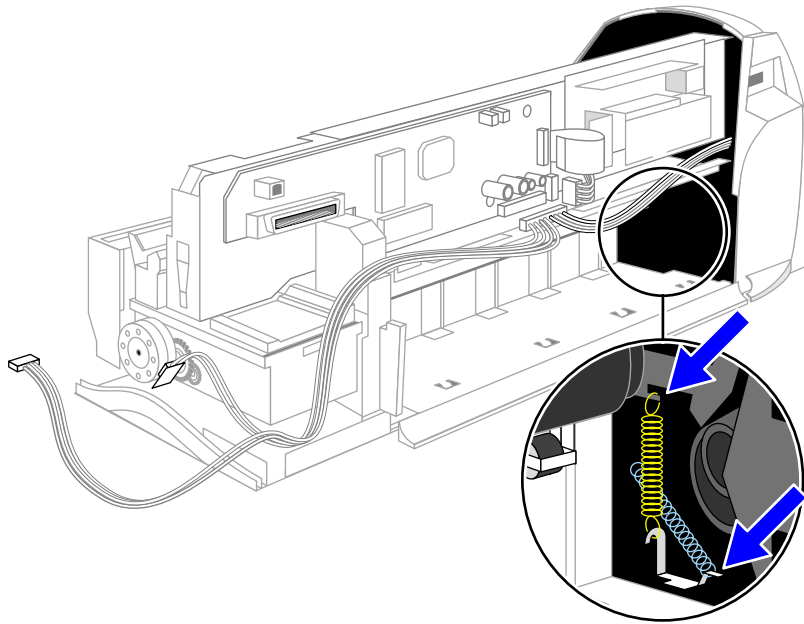

Figure 7.13 Removing the Pivot Spring and Rocker Plate Spring

- 2 Use needle nose pliers to remove each spring.

Rail Cover

First remove the following:

- | | | | |
|---|--------------------------|---|------------------------|
| 1 | Cleanout Trough Assembly | 4 | Access Door Assembly |
| 2 | Stopper Assembly | 5 | Right End Cap Assembly |
| 3 | Output Tray | 6 | Left End Cap Assembly |

- 1 Release the three snap clips (see number one in illustration below).
- 2 Remove the Rail Cover.

Starwheels Assembly

First remove the following:

- | | | | |
|---|--------------------------|---|------------------------|
| 1 | Cleanout Trough Assembly | 4 | Access Door Assembly |
| 2 | Stopper Assembly | 5 | Right End Cap Assembly |
| 3 | Output Tray | 6 | Left End Cap Assembly |
| | | 7 | Rail Cover |

- 1 Remove the three screws that secure the Starwheels Assembly to the Left Support Assembly and Right Support Assembly (see number two in illustration below).
- 2 Lift the Starwheels Assembly to remove it from the printer.

Caution

Do not rest the Starwheels Assembly on the starwheels; the weight of the assembly may damage them.

Output Mechanism Assembly

First remove the following:

- | | |
|----------------------------|--------------------------|
| 1 Cleanout Trough Assembly | 5 Right End Cap Assembly |
| 2 Stopper Assembly | 6 Left End Cap Assembly |
| 3 Output Tray | 7 Rail Cover |
| 4 Access Door Assembly | 8 Starwheels Assembly |

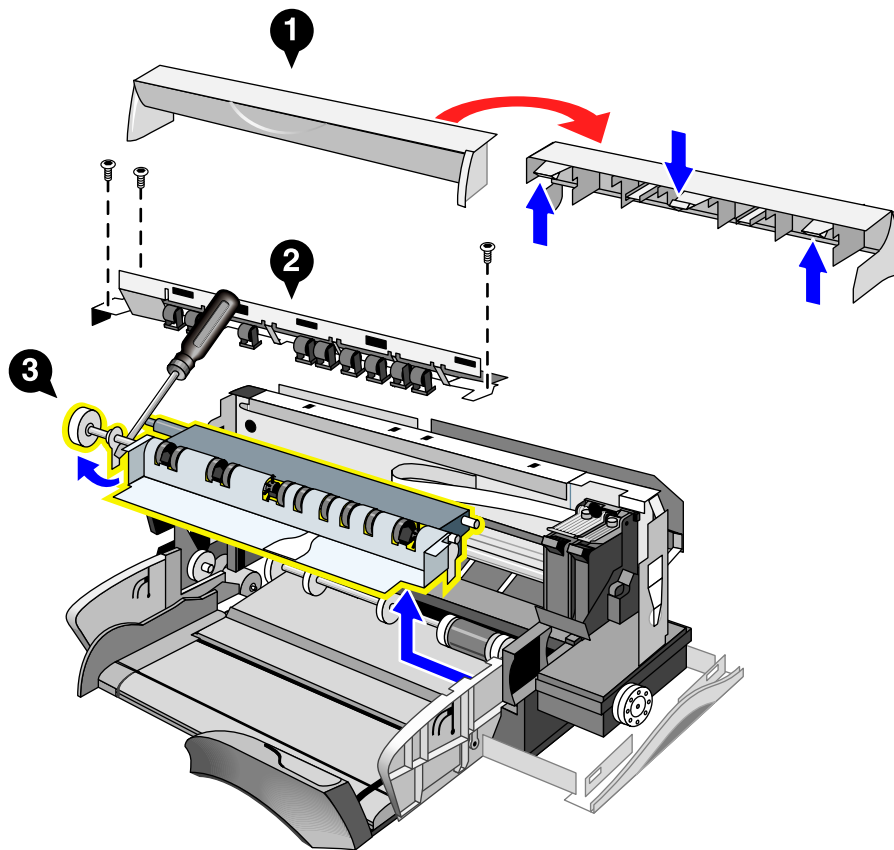

Figure 7.14 Removing the Rail Cover, Starwheels Assembly, and Output Mechanism Assembly

- 1 Use a flathead screwdriver to unlock the plastic bearing on the left side of the assembly. Rotate the bearing until it is in a position that allows you to slide it toward the center of the printer. (See number three in illustration above.)
- 2 Lift and rotate the plastic bearing (Output Bearing) on the right end of the Output Mechanism Assembly. Pull to remove the bearing.

- 3 Pull the Output Mechanism Assembly toward you and lift up to remove.

Note

To reinstall, position the Output Mechanism Assembly with the back of it pointing down, then rotate up as you set it into place.

Output Motor Assembly

First remove the following:

- | | |
|----------------------------|-----------------------------|
| 1 Cleanout Trough Assembly | 5 Right End Cap Assembly |
| 2 Stopper Assembly | 6 Left End Cap Assembly |
| 3 Output Tray | 7 Rail Cover |
| 4 Access Door Assembly | 8 Starwheels Assembly |
| | 9 Output Mechanism Assembly |

- 1 Disconnect the Main Logic Harness Assembly from the Output Motor Assembly.
- 2 Remove the three T-20 screws that connect the motor to the Left Support Assembly.
- 3 Feed the cable under the routing clips.
- 4 Pull Output Motor Assembly out to remove.

Input Tray Assembly

First remove the following:

- | | |
|----------------------------|-----------------------------|
| 1 Cleanout Trough Assembly | 5 Right End Cap Assembly |
| 2 Stopper Assembly | 6 Left End Cap Assembly |
| 3 Output Tray | 7 Rail Cover |
| 4 Access Door Assembly | 8 Starwheels Assembly |
| | 9 Output Mechanism Assembly |

- 1 Remove the three T-20 screws that secure the Input Tray Assembly to the Base Plate. These are the longest T-20 screws in the printer.

- 2 Press the pressure plate down and pull the Input Tray Assembly up and toward you to remove.

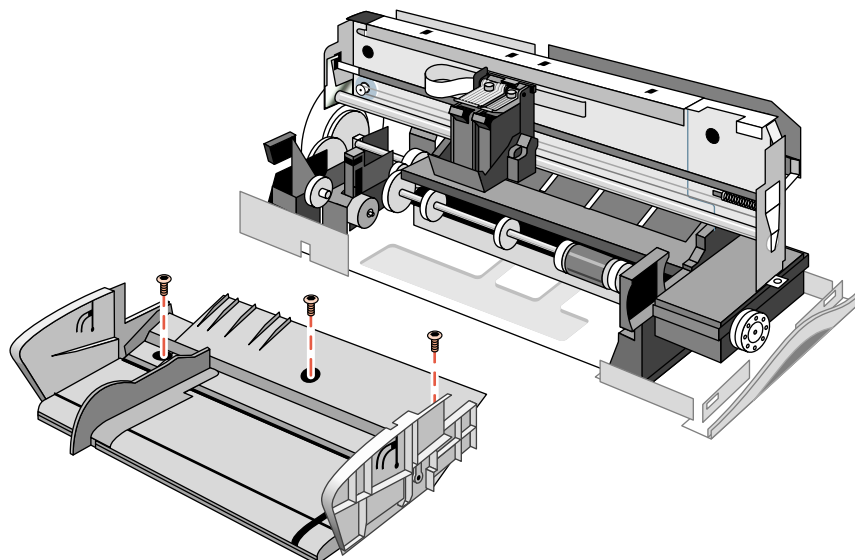

Figure 7.15 Removing the Input Tray Assembly

Pick Roller Assembly

First remove the following:

- | | |
|----------------------------|-----------------------------|
| 1 Cleanout Trough Assembly | 6 Left End Cap Assembly |
| 2 Stopper Assembly | 7 Rail Cover |
| 3 Output Tray | 8 Starwheels Assembly |
| 4 Access Door Assembly | 9 Output Mechanism Assembly |
| 5 Right End Cap Assembly | 10 Input Tray Assembly |

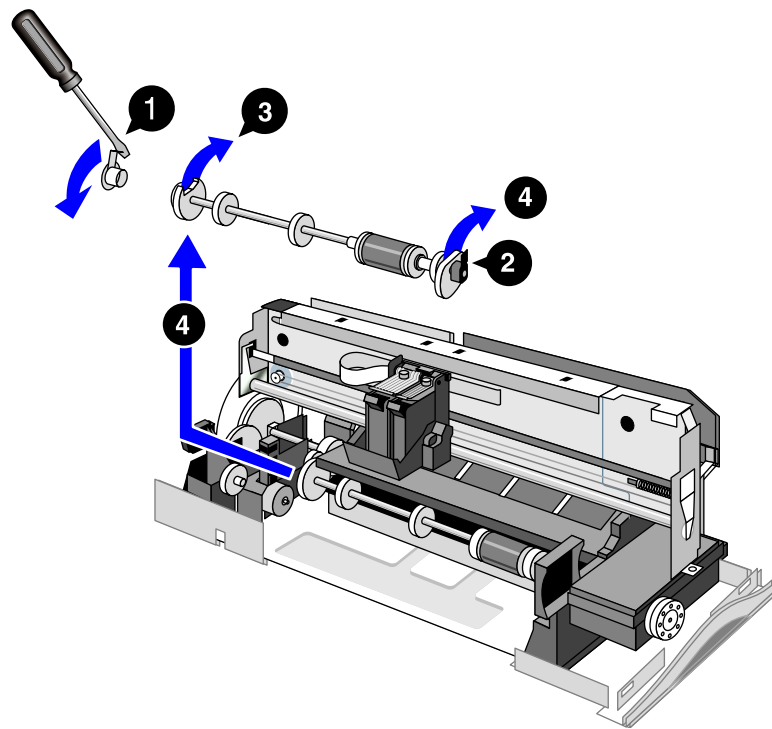

Figure 7.16 Removing the Pick Roller Assembly

- 1 On the left end, rotate the plastic bearing (Left Input Bearing) and then pull it off to remove.
- 2 On the right side, rotate the plastic bearing (Right Pick Roller Bearing) until the right end of the Pick Roller Assembly is released.
- 3 Rotate left end of the Pick Roller Assembly until it is free.

- 4 Rotate the D-cam on the right end of the Pick Roller Assembly and slide the assembly toward you to remove.

Note

When reinstalling, take care to rotate the Pick Roller Assembly so it fits properly.

Serviceable Parts that Require Calibration

The following parts are Service Level 3 parts, serviceable only by HP Technical Support. In addition to using the common tools listed in *Removal and Replacement Tools* on page 7-3, a specialized Pen-to-Paper Spacing Calibration Tool is required. When any of these parts are moved or replaced, the pen-to-paper spacing must be calibrated. For instructions on calibrating the printer, see *Calibrating the Printer* on page 7-37.

Carriage Assembly/Carriage Rod

First remove the following:

- | | | | |
|---|--------------------------|---|------------------------|
| 1 | Cleanout Trough Assembly | 4 | Access Door Assembly |
| 2 | Stopper Assembly | 5 | Right End Cap Assembly |
| 3 | Output Tray | 6 | Left End Cap Assembly |
| | | 7 | Encoder Strip |

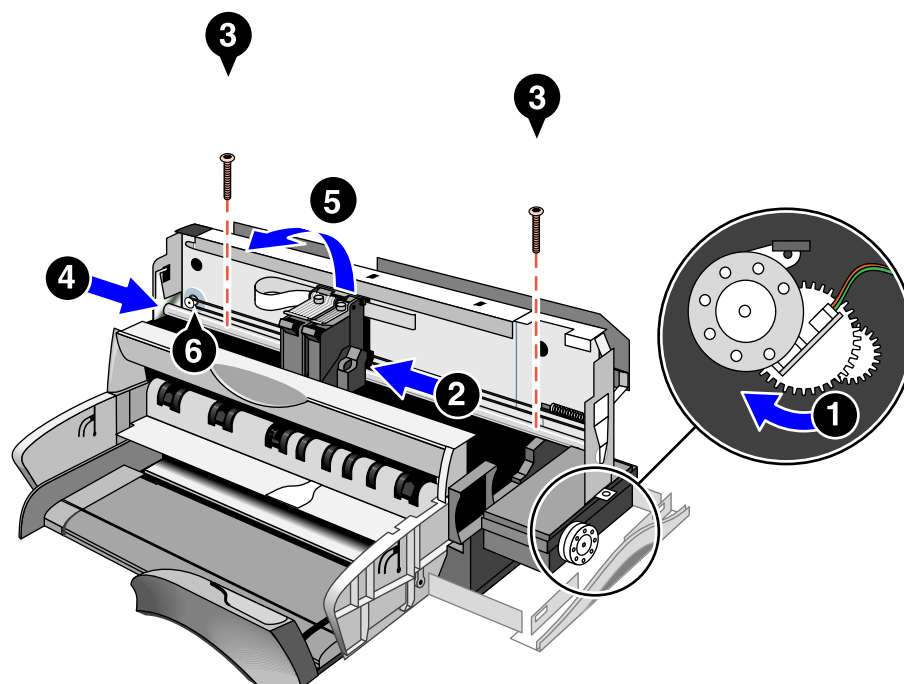

Figure 7.17 Removing the Carriage Assembly/Carriage Rod

- 1 Locate the gear on the right side of the Service Station. To unlock the Carriage, turn the gear clockwise three revolutions.

- 2 Slide the Carriage toward the center of the printer.
- 3 Remove the two T-10 screws that attach the Carriage Rod to the Right Support Assembly and the Left Support Assembly.
- 4 Push the Carriage Rod toward the right and then pull the left end of Carriage Rod out of bracket.
- 5 Tilt the Carriage towards you and then pull it up to remove it from the printer. At this point, it is still attached to the printer by the Flex Cable and the Carriage Belt.
- 6 Unhook the Carriage Belt from the back of the Carriage.
- 7 The Flex Cable is attached to the Carriage PCA by means of an interlocking catch. Press the Flex Cable toward the openings of the interlocking catch until it releases and pull to remove.
- 8 Slide the Carriage Rod out of the Carriage.

Note

Before reinstalling the Carriage Assembly:

- Reinsert the Flex Cable into the Carriage PCA. Make sure the plastic guides on the Flex Cable are properly reinserted into the interlocking catch.
- Make sure the Carriage Belt is attached to the Carriage and is properly positioned behind the Carriage Rod.

Flex Cable

First remove the following:

- | | |
|----------------------------|----------------------------------|
| 1 Cleanout Trough Assembly | 5 Right End Cap Assembly |
| 2 Stopper Assembly | 6 Left End Cap Assembly |
| 3 Output Tray | 7 Encoder Strip |
| 4 Access Door Assembly | 8 Carriage Assembly/Carriage Rod |

- 1 Turn the printer around so you are facing the back of the printer.
- 2 Pinch bottom of the Ferrite Clip to release bracket.
- 3 Remove the Ferrite Clip and Ferrite.
- 4 Release the tabs on the Flex Cable and remove.

Backbone Assembly

First remove the following:

- | | |
|----------------------------|----------------------------------|
| 1 Cleanout Trough Assembly | 5 Right End Cap Assembly |
| 2 Stopper Assembly | 6 Left End Cap Assembly |
| 3 Output Tray | 7 Encoder Strip |
| 4 Access Door Assembly | 8 Carriage Assembly/Carriage Rod |

- 1 From the front of the printer, remove the four T-20 screws that secure the Backbone Assembly to the Left Support Assembly and Right Support Assembly.
- 2 Pull Backbone Assembly toward you to remove.

Upper Paper Guide Assembly

First remove the following:

- | | |
|----------------------------|----------------------------------|
| 1 Cleanout Trough Assembly | 5 Right End Cap Assembly |
| 2 Stopper Assembly | 6 Left End Cap Assembly |
| 3 Output Tray | 7 Encoder Strip |
| 4 Access Door Assembly | 8 Carriage Assembly/Carriage Rod |
| | 9 Backbone Assembly |

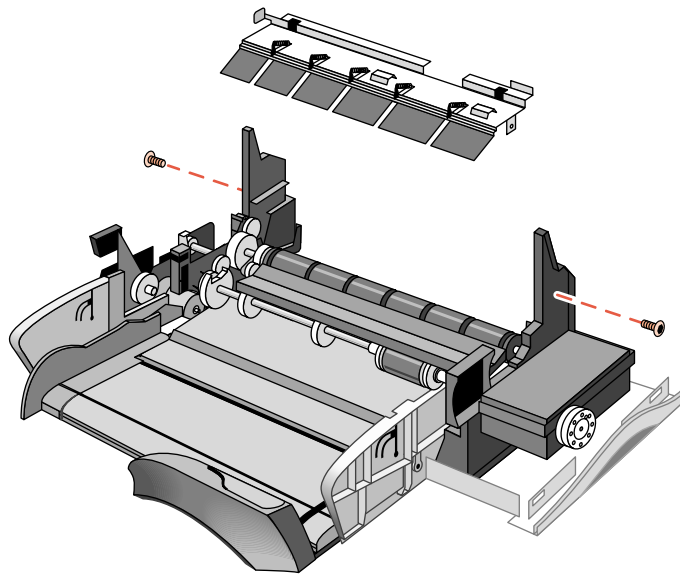

Figure 7.18 Removing the Upper Paper Guide Assembly

- 1 In both the Left Support Assembly and Right Support Assembly there is a recessed T-10 screw that secures the Upper Paper Guide Assembly. Remove these two screws.
- 2 The Upper Paper Guide Assembly is spring loaded. Tilt plate up and pull plate toward the front of the printer. The plate will release.

Note

The Upper Paper Guide Assembly fits into slots on the Left and Right Support Assemblies. To reassemble, push down on the Upper Paper Guide Assembly and slide the left side of the roller plate into the slots first. Ensure all pinch rollers are in place.

Drive Roller Assembly

First remove the following:

- | | |
|---|----------------------------------|
| 1 Cleanout Trough Assembly | 7 Left End Cap Assembly |
| 2 Rocker Plate Spring and
Pivot Spring | 8 Encoder Strip |
| 3 Stopper Assembly | 9 Carriage Assembly/Carriage Rod |
| 4 Output Tray | 10 Backbone Assembly |
| 5 Access Door Assembly | 11 Upper Paper Guide Assembly |
| 6 Right End Cap Assembly | |

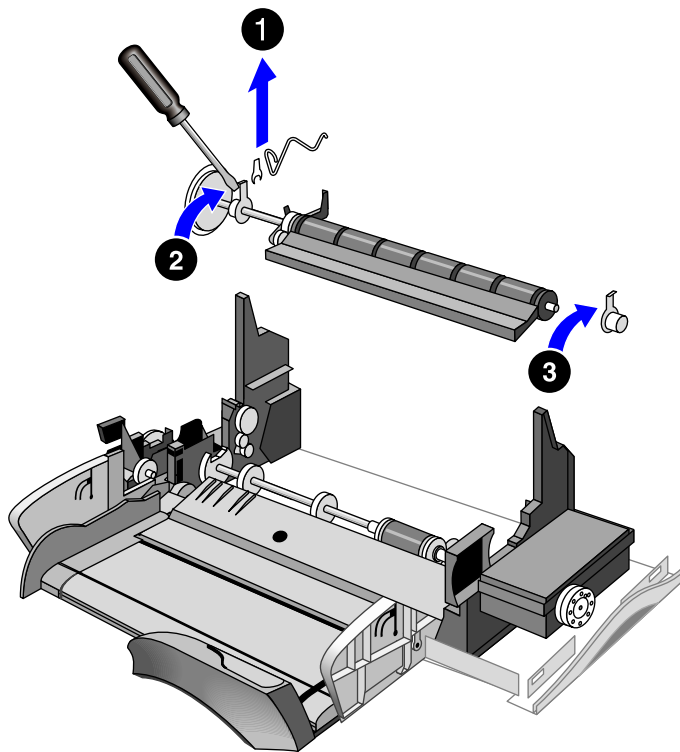

Figure 7.19 Removing the Drive Roller Assembly

- 1 Remove the spring (Preloader Spring) and clip (Drive Sleeve) from the left side of the Drive Roller Assembly.
- 2 On the left side, lift and rotate the plastic locking bearing until you can slide it toward the center of the printer.

- 3 On the right side of the Drive Roller Assembly, lift up and rotate the locking plastic bearing (Right Drive Bearing) until you are able to pull it out and remove it.
- 4 Lift platen and remove the Drive Roller Assembly.

Note

When reassembling, make sure that:

- All gears are properly realigned.
- The Encoder Disk is properly seated on the Base Plate.
- The Output Belt is reattached to the Encoder Disk (it will hang loosely until the printer is further reassembled).

Trough-1 Assembly

First remove the following:

- | | |
|---|----------------------------------|
| 1 Cleanout Trough Assembly | 7 Left End Cap Assembly |
| 2 Rocker Plate Spring and
Pivot Spring | 8 Encoder Strip |
| 3 Stopper Assembly | 9 Carriage Assembly/Carriage Rod |
| 4 Output Tray | 10 Backbone Assembly |
| 5 Access Door Assembly | 11 Upper Paper Guide Assembly |
| 6 Right End Cap Assembly | 12 Drive Roller Assembly |

- 1 Facing the back of the printer, remove the two T-20 screws that secure the Trough-1 Assembly to the Base Plate.
- 2 Use a flathead screwdriver to press and release the four catches.
- 3 Lift the back of the Trough-1 Assembly upward and remove the Trough-1 Assembly.

Right Support Assembly

First remove the following:

- | | |
|---|-------------------------------|
| 1 Cleanout Trough Assembly | 10 Backbone Assembly |
| 2 Rocker Plate Spring and
Pivot Spring | 11 Rail Cover |
| 3 Stopper Assembly | 12 Starwheels Assembly |
| 4 Output Tray | 13 Output Mechanism Assembly |
| 5 Access Door Assembly | 14 Upper Paper Guide Assembly |
| 6 Right End Cap Assembly | 15 Drive Roller Assembly |
| 7 Left End Cap Assembly | 16 Input Tray Assembly |
| 8 Encoder Strip | 17 Pick Roller Assembly |
| 9 Carriage Assembly/Car-
riage Rod | 18 Trough-1 Assembly |

- 1 Remove the three T-20 screws that attach the Right Support Assembly to the Base Plate.

Note

The Left Support and Right Support Assemblies each contain a Rod Mount that is used to secure the Carriage Rod in place. Make sure these Rod Mounts are in place when the Left Support and Right Support Assemblies are reinstalled; they are difficult to replace later on in the reassembly process.

Left Support Assembly

First remove the following:

- | | |
|---|-------------------------------|
| 1 Cleanout Trough Assembly | 10 Backbone Assembly |
| 2 Rocker Plate Spring and
Pivot Spring | 11 Rail Cover |
| 3 Stopper Assembly | 12 Starwheels Assembly |
| 4 Output Tray | 13 Output Mechanism Assembly |
| 5 Access Door Assembly | 14 Upper Paper Guide Assembly |
| 6 Right End Cap Assembly | 15 Drive Roller Assembly |
| 7 Left End Cap Assembly | 16 Input Tray Assembly |
| 8 Encoder Strip | 17 Pick Roller Assembly |
| 9 Carriage Assembly/
Carriage Rod | 18 Trough-1 Assembly |

- 1 Remove the five T-20 screws that attach the Left Support Assembly to the Base Plate.

Note

Do not remove the Line Feed Motor or the Transmission Belt. Removing these parts will require you to adjust the belt tension.

Base Plate Assembly

First remove the following:

- | | |
|---|-------------------------------|
| 1 Cleanout Trough Assembly | 10 Backbone Assembly |
| 2 Rocker Plate Spring and
Pivot Spring | 11 Rail Cover |
| 3 Stopper Assembly | 12 Starwheels Assembly |
| 4 Output Tray | 13 Output Mechanism Assembly |
| 5 Access Door Assembly | 14 Upper Paper Guide Assembly |
| 6 Right End Cap Assembly | 15 Drive Roller Assembly |
| 7 Left End Cap Assembly | 16 Input Tray Assembly |
| 8 Encoder Strip | 17 Pick Roller Assembly |
| 9 Carriage Assembly/
Carriage Rod | 18 Trough-1 Assembly |
| | 19 Right Support Assembly |
| | 20 Left Support Assembly |

- 1 If necessary, you may also remove the Rubber Feet and Hands Grabs from the Base Plate Assembly.

Removal of Subassembly Parts

Table 7.1 Removal of Subassembly Parts

Assembly	Subassembly Part	Service Level*	Removal Instructions
Cleanout Trough	Rear Roller Springs and Trough Rollers	2	Remove each pair of springs and rollers and then remove the spring from the roller.
Access Door	Main Back Panel and Access Door	2	Pull to separate.
Power Supply	Power Supply Harness Assembly	2	Disconnect from the Logic PCA and Power Supply Assemblies.
Service Station Mechanism	Service Station Motor Assembly	3	Remove the T-10 screw from the motor. Tilt the motor up and then pull it off.
	Wiper Assembly	3	Use a flathead screwdriver to release the two catches and remove.
	Sponge	3	Remove the two T-10 screws from the top of the Service Station Mechanism. Use a flathead screwdriver to release the two catches and remove the top of the Service Station Mechanism Assembly. Remove the Pallet Assembly and Service Station Drive Shaft to access the Sponge.

Table 7.1 Removal of Subassembly Parts

Carriage	Carriage PCA	3	Remove the five T-10 screws, and the slider and belt attach plastics from the back of the Carriage.
	ESD Springs and ESD Blades	3	Ensure the springs and blades are properly seated before replacing the Carriage PCA.
Backbone	Rod Spring and Encoder Spring	3	Use needle nose pliers to remove.
Drive Roller	Pivot Guides and Pivot	3	Release the clip ends and remove.
Trough-1	Rear Roller Springs and Trough Rollers	3	Remove each pair of springs and rollers and then remove the spring from the roller.
	Input Kicker Spring	3	
	Pick Separator Assembly	3	Use a flathead screwdriver to release the two catches. Remove Pick Separator and Separator Spring.
Left Support	Index Sensor and Index Sensor Harness	3	Use a flathead screwdriver to remove plastic clip and disconnect the cable harness.

* Service Levels: 2=Authorized Service Providers and above; 3=HP Technical Support only.

Calibrating the Printer

The only calibration the HP 1220C printer requires is the pen-to-paper spacing. When properly calibrated, the printer provides optimum print quality without compromising media handling capabilities. Print quality improves as the print cartridges move closer to the media. However, if the cartridges are too close to the media, paper jams, print skew or print smear may occur.

To maintain accurate pen-to-paper spacing, you must calibrate the printer whenever the Carriage Rod is moved or removed. Removal and replacement of the following printer parts affect pen-to-paper spacing and require calibration:

- Carriage Assembly/Carriage Rod
- Backbone Assembly
- Upper Paper Guide Assembly
- Drive Roller Assembly
- Trough-1 Assembly
- Right Support Assembly
- Left Support Assembly

Calibration Tool

To calibrate the pen-to-paper spacing, use the Pen-to-Paper Spacing Calibration tool (PPS Calibration tool). The recommended tool is the HP Desk Jet PPS Test Tool, part number C6569A. However, you can also use the older models of the PPS Calibration tool that have a dial with a pointer hand. Calibration procedures for both tools are described below.

How to Calibrate

Before You Begin

- 1 Remove the Cleanout Trough Assembly.
- 2 Ensure the Pivot is fully raised; this is its normal position.
- 3 Locate the gear on the right side of the Service Station. To unlock the Carriage, turn the gear clockwise three revolutions.

- 4 Remove the black and color print cartridges.

Using PPS Calibration Tool (part number C6569A)

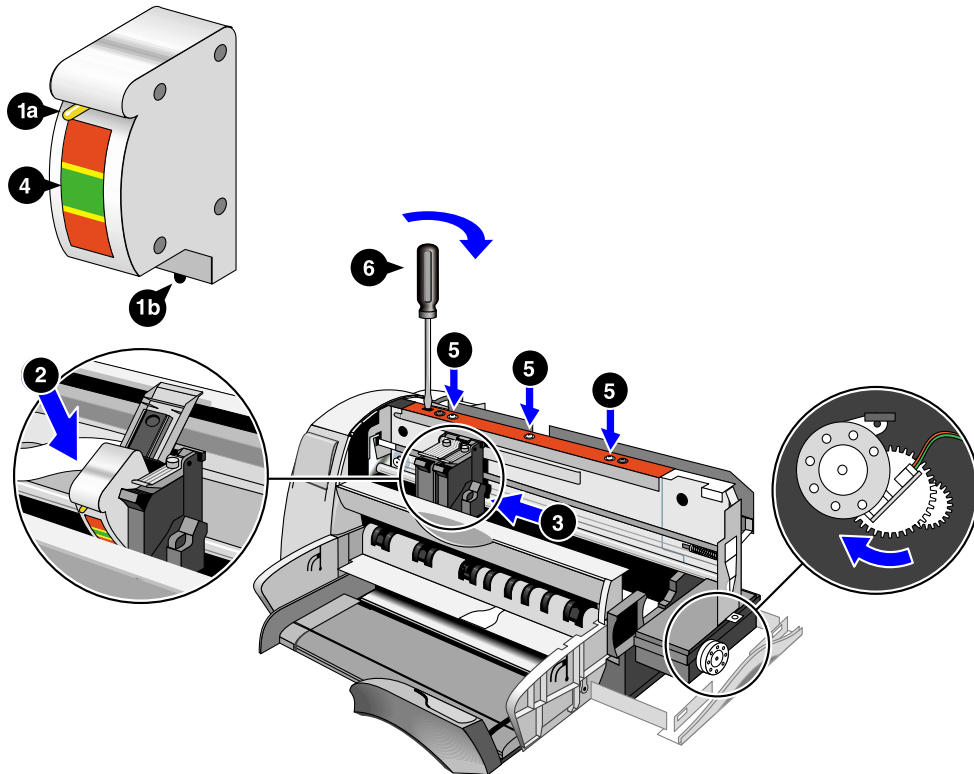

Figure 7.20 Calibrating the Printer

- 1 Pull out the latch (1a) on the PPS Calibration Tool; this will retract the tool's probe tip (1b) and prevent damage to the tool and the printer.
- 2 Insert the PPS Calibration Tool into the color cartridge cradle and close the print cartridge latches. Make sure the Carriage can move freely.
- 3 Move the Carriage to align the ESD clip on the color cartridge cradle with the fifth cockle rib to the left of the pivot. The Carriage will now be near the left end of the Carriage Rod.
- 4 Gently push the latch on the PPS Calibration Tool to release the probe and measure the pen-to-paper spacing. It should read 55 +/- 10 mils.
- 5 To adjust PPS, loosen the three silver screws that secure the Upper Rail to the Backbone Assembly. Insert a flathead screwdriver into the slot on the

Upper Rail that is closest to the Carriage. Turn the screwdriver until the tool reads 55 +/- 10 mils.

Caution

Do not loosen the black screws that secure the Upper Rail to the Backbone Assembly. The black screws have been specifically torqued to provide proper tension for PPS adjustments.

- 6 Raise the PPS Tool latch and move the Carriage to align the ESD clip on the color cartridge cradle with the third cockle rib to the right of the pivot. The Carriage will now be near the right end of the Carriage Rod.
- 7 Repeat steps four and five.
- 8 Recheck your first measurement near the left end of the Carriage Rod; adjusting the right end of the Carriage Rod can affect the left side. Readjust the left end if necessary.
- 9 Tighten the silver screws.

Using the LVDT Calibration Tool

- 1 Move the Carriage to align the ESD clip on the black cartridge cradle with the fifth cockle rib to the left of the pivot. The Carriage will now be near the left end of the Carriage Rod.
- 2 Insert the LVDT Calibration Tool into the black cartridge cradle and close the print cartridge latches.

Caution

Do not move the Carriage while the LVDT Calibration Tool is in the printer; you will damage the tool and the cockle rib.

- 3 Ensure the probe tip of the tool is resting on the cockle rib and check the PPS measurement. The MP-1000 should read 55 mil +/- 10.
- 4 To adjust PPS, loosen the three silver screws that secure the Upper Rail to the Backbone Assembly. Insert a flathead screwdriver into the slot on the Upper Rail that is closest to the Carriage. Turn the screwdriver until the MP-1000 reads 55 mil +/- 10.

Caution

Do not loosen the black screws that secure the Upper Rail to the Backbone Assembly. The black screws have been specifically torqued to provide proper tension for PPS adjustments.

- 5 Lift the trigger on the LVDT Calibration Tool and move the Carriage to align the ESD clip on the black cartridge cradle with the third cockle rib to

the right of the pivot. The Carriage will now be near the right end of the Carriage Rod.

Note

Make sure the trigger of the LVDT tool is lifted up when moving the Carriage.

- 6** Repeat steps two through four.
- 7** Recheck your first measurement near the left end of the Carriage Rod; adjusting the right end of the Carriage Rod can affect the left side. Readjust the left end if necessary.
- 8** Tighten the silver screws.

Parts and Diagrams

Exploded View	8-2
Exploded View Parts List	8-3
Subassembly Exploded Views	8-7
Subassembly Exploded Views Parts List	8-11
Alphabetical Parts List	8-13
Numerical Parts List	8-17
Low Usage Kits	8-21

Exploded View

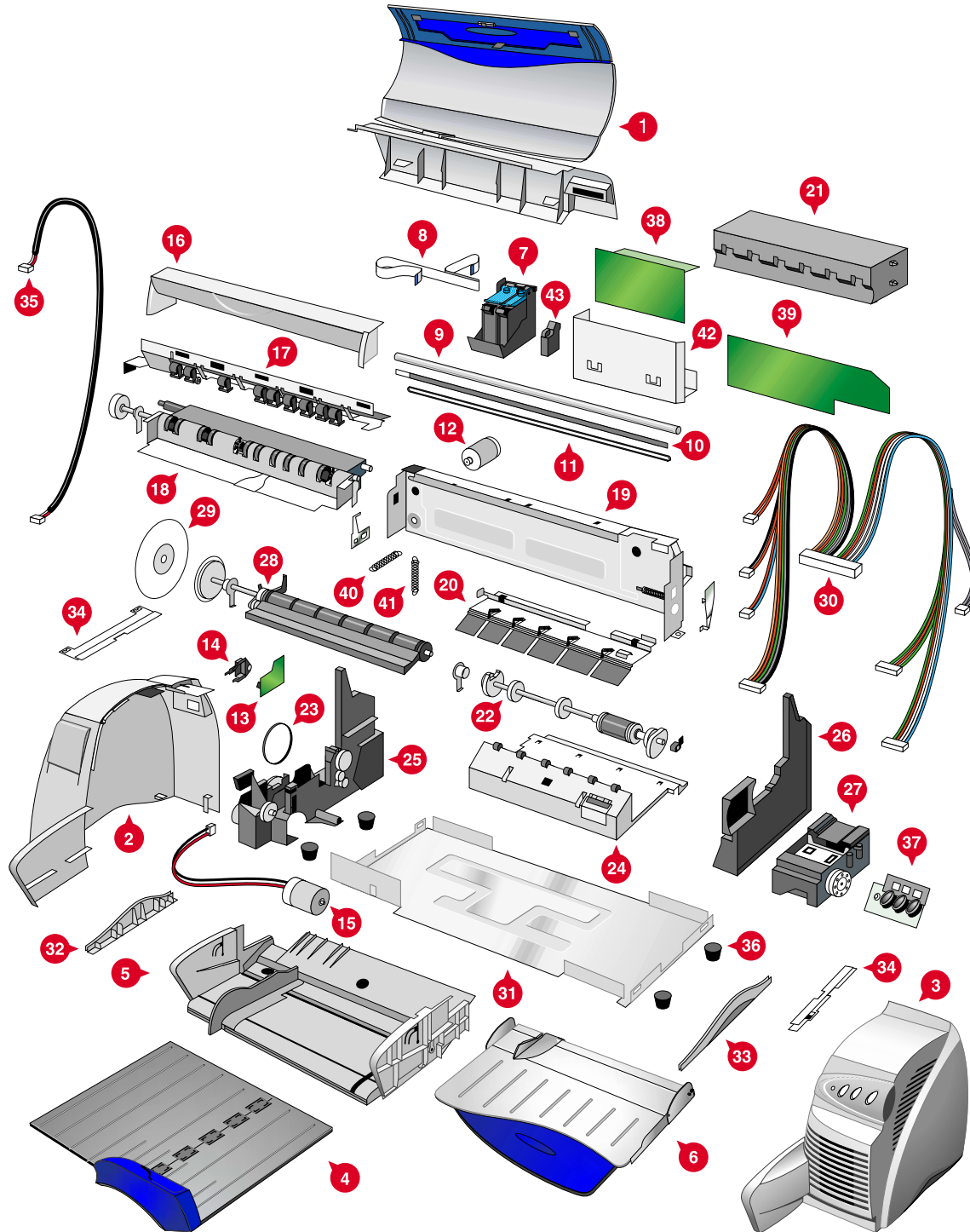

Figure 8.1 Exploded View

Exploded View Parts List

Table 8.1 Exploded View Parts List

















Exploded Views	Part Description	Service Level*	Bar Code with Part Number	For repair information, see
1, A	Access Door Assembly	2	 C2693-67008	page 7-9
2	Left End Cap Assembly	2	 C2693-67004	page 7-11
3	Right End Cap Assembly	2	 C2693-67005	page 7-13
4	Stopper Assembly	1	 C2693-67001	page 7-6
5	Input Tray Assembly	2	 C2693-67019	page 7-23
6	Output Tray Assembly	1	 C2693-67002	page 7-6
7, E	Carriage Assembly	3	 C2693-67035	page 7-27
8	Flex Cable	3	 C2693-67026	page 7-28
10	Encoder Strip	2	 C2693-67015	page 7-17
11	Carriage Belt	3	 C2693-67016	page 7-28
12	Carriage Motor Assembly	2	 C2693-67017	page 7-18
13	Linefeed/Encoder PCA	2	 C2693-67045	page 7-15
14	Encoder Guide	3	 C2693-67050	page 7-15
15	Output Motor Assembly	2	 C2693-67044	page 7-23
16	Rail Cover	2	 C2693-67029	page 7-21
17	Starwheels Assembly	2	 C2693-67027	page 7-21

Table 8.1 Exploded View Parts List



















18	Output Mechanism Assembly	2	 C2693-67024	page 7-22
19, J	Backbone Assembly	3	 C2693-67048	page 7-29
20	Upper Paper Guide Assembly	3	 C2693-67023	page 7-29
21, A	Cleanout Trough Assembly	1	 C2693-67003	page 7-7
22	Pick Roller Assembly	2	 C2693-67018	page 7-25
23	Output Belt	2	 C2693-67025	page 7-16
24, G	Trough-1 Assembly	3	 C2693-67030	page 7-32
25, H	Left Support Assembly	3	 C2693-67043	page 7-34
26	Right Support Assembly	3	 C2693-67049	page 7-33
27, C	Service Station Mechanism Assembly	2	 C2693-67039	page 7-19
28, F	Drive Roller Assembly	3	 C2693-67020	page 7-31
29	Encoder Disk Assembly	2	 C2693-67031	page 7-16
30	Main Logic Harness Assembly	2	 C2693-67014	page 7-14
31	Base Plate Assembly	3	 C2693-67028	page 7-34
32, 33	Hand Grabs	2	 C2693-67033	page 7-15
34	Stopper Guides	2	 C2693-67034	page 7-8
35	Power Switch Harness	2	 C2693-67007	page 7-15
36	Rubber Feet	2	 C2693-67053	page 7-9
37	Keypanel PCA	2	 C2693-67006	page 7-14

Table 8.1 Exploded View Parts List























38, D	Power Supply Assembly	2	 C2693-67012	page 7-12
39	Logic PCA Assembly	2	 C2693-67010	page 7-10
42	Power Insulator	2	 C2693-67013	page 7-13
43	Spot Sensor Assembly	2	 C2693-67037	page 7-19
A	Main Back Panel	2	 C2693-67009	page 7-35
C	Service Station Motor Assembly	3	 C2693-67040	page 7-35
C	Wiper Assembly	3	 C2693-67041	page 7-35
C	Sponge	3	 C2693-67042	page 7-19
D	Power Supply Harness Assembly	2	 C2693-67011	page 7-35
E	Carriage PCA	3	 C2693-67036	page 7-28
F	Pivot	3	 C2693-67021	page 7-36
F	Pivot Guide	3	 C2693-67022	page 7-36
G	Pick Separator Assembly	3	 C2693-67032	page 7-36
H	Index Sensor Harness	2	 C2693-67046	page 7-35
H	Index Sensor	2	 C2693-67047	page 7-35
K	Spot Sensor Cable Assembly	2	 C2693-67038	page 7-20
K	ESD Cover	2	 C2693-67051	page 7-20
	Low Usage Kit 1	2	 C2693-67052	page 8-7
	Low Usage Kit 2	2	 C2693-67053	page 8-7

Table 8.1 Exploded View Parts List

Logic PCA Assembly - EEU	2	 C2693-67054	page 7-10
Printer Brick - AO	2	 C2693-67055	
Printer Brick - EEU	2	 C2693-67056	

Subassembly Exploded Views

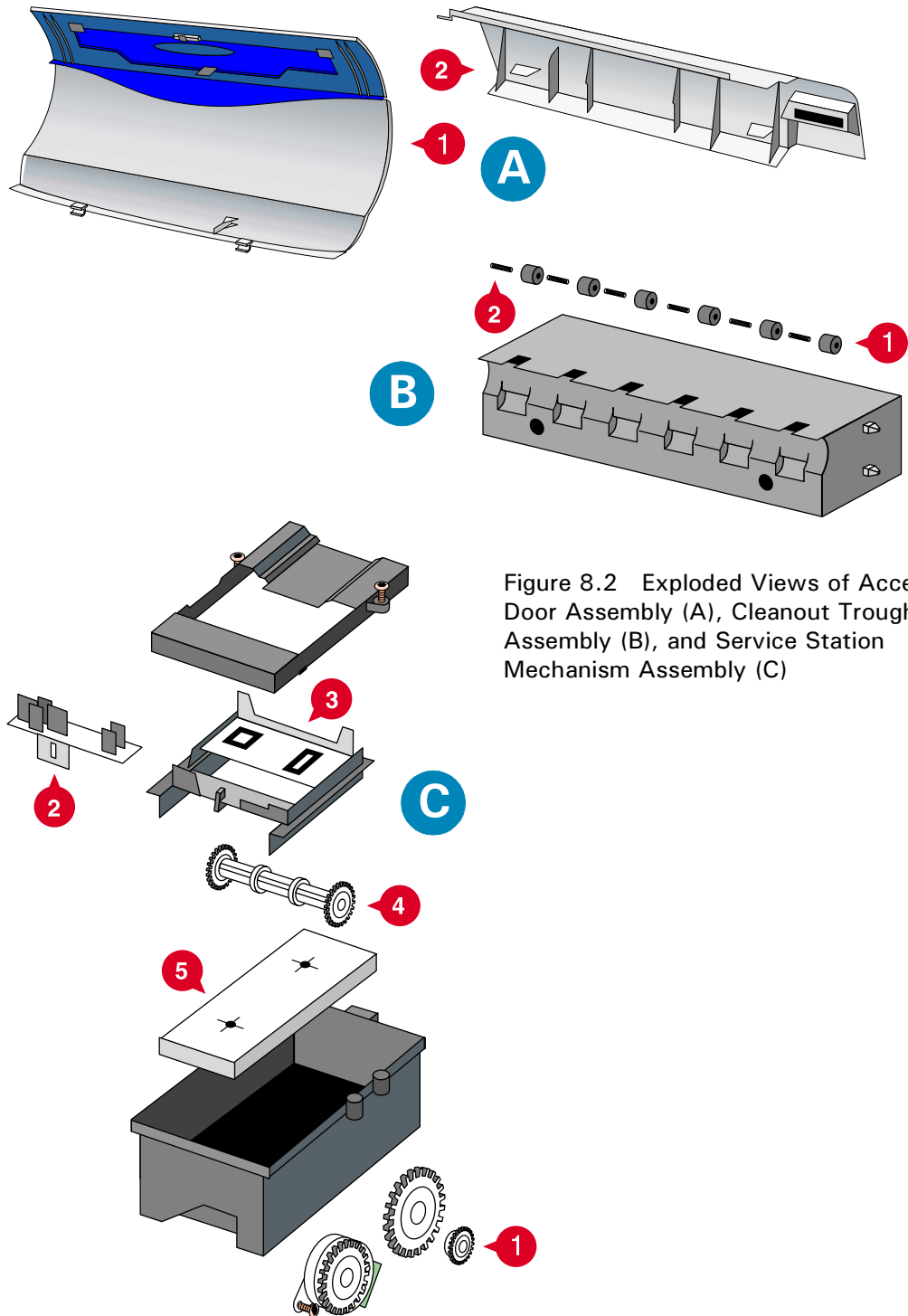

Figure 8.2 Exploded Views of Access Door Assembly (A), Cleanout Trough Assembly (B), and Service Station Mechanism Assembly (C)

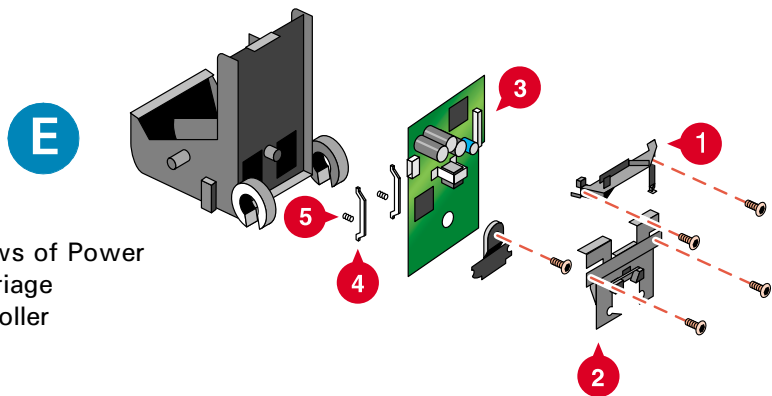
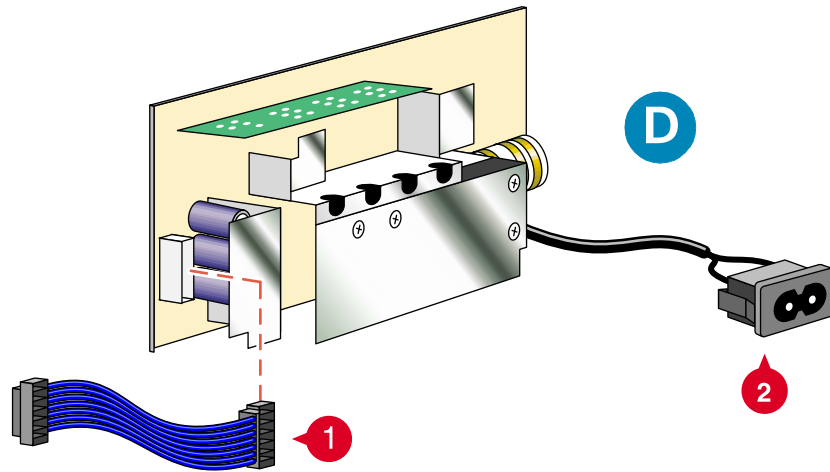
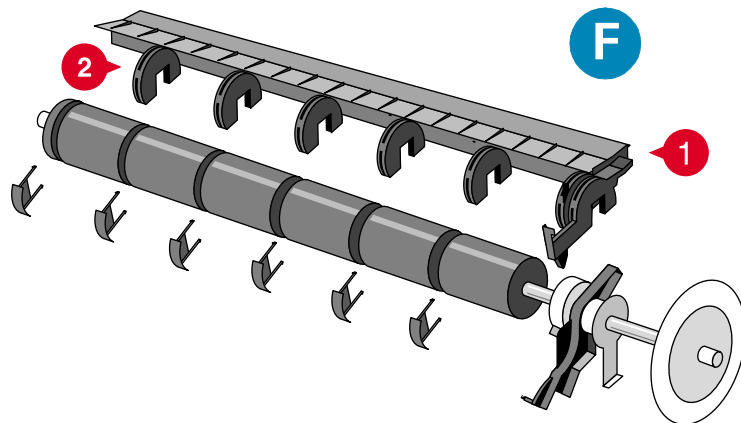

Figure 8.3 Exploded Views of Power Supply Assembly (D), Carriage Assembly (E), and Drive Roller Assembly (F)



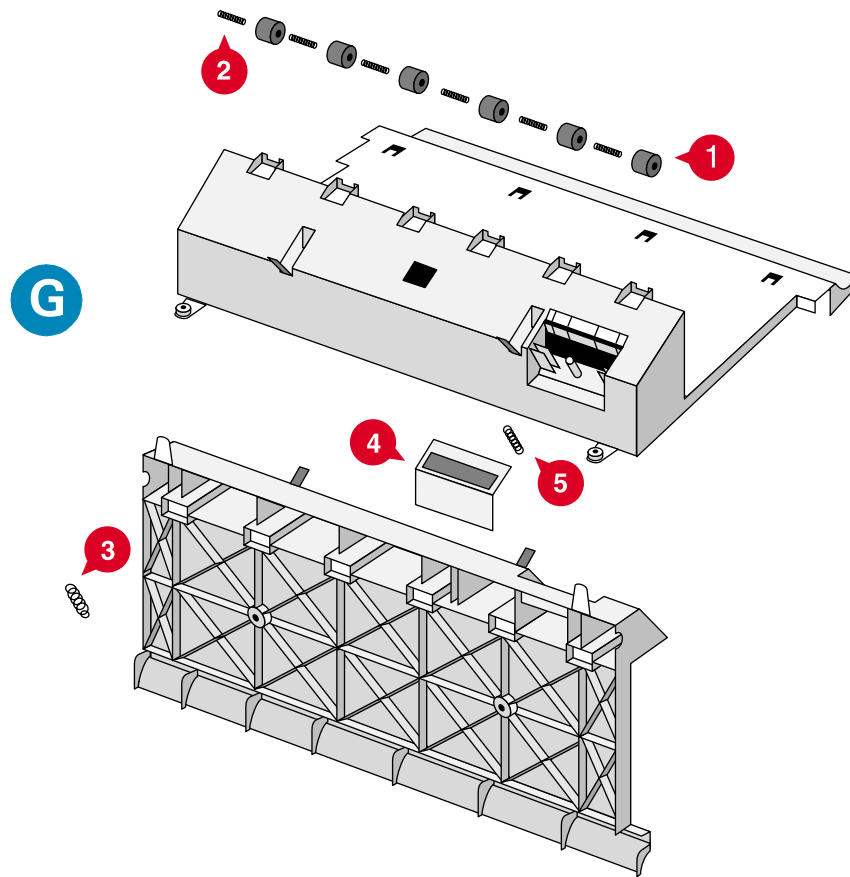
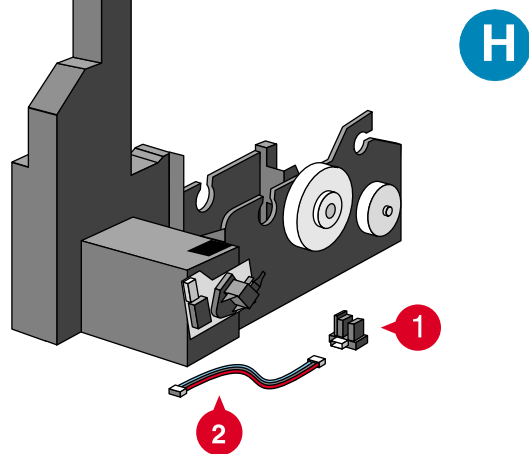

Figure 8.4 Exploded Views of Trough-1 Assembly (G) and Left Support Assembly (H)



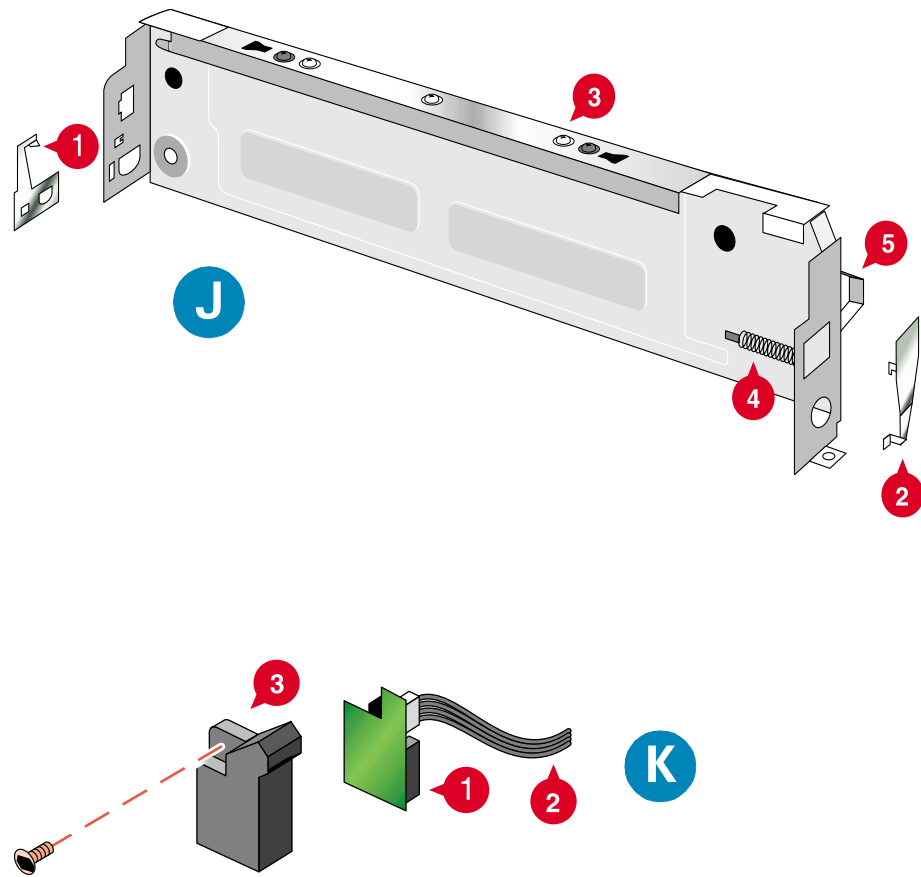

Figure 8.5 Exploded Views of Backbone Assembly (J) and Spot Sensor Assembly (K)

Subassembly Exploded Views Parts List

Table 8.2 Subassembly Exploded Views Parts List

Subassembly Exploded View	Part Number	Part	For repair information, see	Comments
A: Access Door Assembly	1	Access Door	page 7-35	To replace, order Access Door Assembly.
	2	Main Back Panel	page 7-35	
B: Cleanout Trough Assembly	1	Trough Roller	page 7-35	Parts located in Low Usage Kit 2.
	2	Rear Roller Spring	page 7-35	Parts located in Low Usage Kit 2.
C: Service Station Mechanism Assembly	1	Service Station Motor Assembly	page 7-35	
	2	Wiper Assembly	page 7-35	
	3	Pallet Assembly	page 7-35	To replace, order Service Station Mechanism Assembly.
	4	Service Station Drive Shaft	page 7-35	To replace, order Service Station Mechanism Assembly.
	5	Sponge	page 7-35	
D: Power Supply Assembly	1	Power Supply Harness Assembly	page 7-35	
	2	AC Input Plug	page 7-12	To replace, order Power Supply Assembly.
E: Carriage Assembly	1	Belt Attach	page 7-36	To replace, order Carriage Assembly.
	2	Slider Attach	page 7-36	To replace, order Carriage Assembly.
	3	Carriage PCA	page 7-36	
	4	ESD Blade	page 7-36	Parts located in Low Usage Kit 2.

Table 8.2 Subassembly Exploded Views Parts List

	5	ESD Spring	page 7-36	Parts located in Low Usage Kit 2.
F: Drive Roller Assembly	1	Pivot	page 7-36	
	2	Pivot Guides	page 7-36	
G: Trough-1 Assembly	1	Trough Roller	page 7-35	Parts located in Low Usage Kit 2.
	2	Rear Roller	page 7-35	Parts located in Low Usage Kit 2.
	3	Input Kicker Spring	page 7-36	Parts located in Low Usage Kit 2.
	4	Pick Separator	page 7-36	
	5	Separator Spring	page 7-36	
H: Left Support Assembly	1	Index Sensor	page 7-36	
	2	Index Sensor Harness	page 7-36	
J: Backbone Assembly	1	Encoder Spring	page 7-36	Parts located in Low Usage Kit 2.
	2	Rod Spring	page 7-36	Parts located in Low Usage Kit 2.
	3	Upper Rail	page 7-38	To replace, order Backbone Assembly.
	4	Belt Tension Spring	page 7-18	To replace, order Backbone Assembly.
	5	Turnaround Assembly	page 7-18	To replace, order Backbone Assembly.
K: Spot Sensor Assembly	1	Spot Sensor	page 7-21	
	2	Spot Sensor Harness Assembly	page 7-20	
	3	ESD Cover	page 7-20	

Alphabetical Parts List

Table 8.3 Alphabetical Parts List

















Part Description	Exploded Views	Service Level*	Bar Code with Part Number	For repair information, see
Access Door Assembly	1, A	2	 C2693-67008	page 7-9
Backbone Assembly	19, J	3	 C2693-67048	page 7-29
Base Plate Assembly	31	3	 C2693-67028	page 7-34
Carriage Assembly	7, E	3	 C2693-67035	page 7-27
Carriage Belt	11	3	 C2693-67016	page 7-28
Carriage Motor Assembly	12	2	 C2693-67017	page 7-18
Carriage PCA	E	3	 C2693-67036	page 7-28
Cleanout Trough Assembly	21, A	1	 C2693-67003	page 7-7
Drive Roller Assembly	28, F	3	 C2693-67020	page 7-31
Encoder Disk Assembly	29	2	 C2693-67031	page 7-16
Encoder Guide	14	3	 C2693-67050	page 7-15
Encoder Strip	10	2	 C2693-67015	page 7-17
ESD Cover	K	2	 C2693-67051	page 7-20
Flex Cable	8	3	 C2693-67026	page 7-28
Hand Grabs	32, 33	2	 C2693-67033	page 7-15
Index Sensor	H	2	 C2693-67047	page 7-35

Table 8.3 Alphabetical Parts List



















Index Sensor Harness	H	2	 C2693-67046	page 7-35
Input Tray Assembly	5	2	 C2693-67019	page 7-23
Keypanel PCA	37	2	 C2693-67006	page 7-14
Left End Cap Assembly	2	2	 C2693-67004	page 7-11
Left Support Assembly	25, H	3	 C2693-67043	page 7-34
Linefeed/Encoder PCA	13	2	 C2693-67045	page 7-15
Logic PCA Assembly	39	2	 C2693-67010	page 7-10
Logic PCA Assembly - EEU		2	 C2693-67054	page 7-10
Low Usage Kit 1		2	 C2693-67052	page 8-7
Low Usage Kit 2		2	 C2693-67053	page 8-7
Main Back Panel	A	2	 C2693-67009	page 7-35
Main Logic Harness Assembly	30	2	 C2693-67014	page 7-14
Output Belt	23	2	 C2693-67025	page 7-16
Output Mechanism Assembly	18	2	 C2693-67024	page 7-22
Output Motor Assembly	15	2	 C2693-67044	page 7-23
Output Tray Assembly	6	1	 C2693-67002	page 7-6
Pick Roller Assembly	22	2	 C2693-67018	page 7-25
Pick Separator Assembly	G	3	 C2693-67032	page 7-36
Pivot	F	3	 C2693-67021	page 7-36

Table 8.3 Alphabetical Parts List























Pivot Guide	F	3	 C2693-67022	page 7-36
Power Insulator	42	2	 C2693-67013	page 7-13
Power Supply Assembly	38, D	2	 C2693-67012	page 7-12
Power Supply Harness Assembly	D	2	 C2693-67011	page 7-35
Power Switch Harness	35	2	 C2693-67007	page 7-15
PPS Calibration Tool		3	 C6569A	page 7-37
Printer Brick - AO		2	 C2693-67055	
Printer Brick - EEU		2	 C2693-67056	
Rail Cover	16	2	 C2693-67029	page 7-21
Right End Cap Assembly	3	2	 C2693-67005	page 7-13
Right Support Assembly	26	3	 C2693-67049	page 7-33
Rubber Feet	36	2	 C2693-67053	page 7-9
Service Station Mechanism Assembly	27, C	2	 C2693-67039	page 7-19
Service Station Motor Assembly	C	3	 C2693-67040	page 7-35
Sponge	C	3	 C2693-67042	page 7-19
Spot Sensor Assembly	43	2	 C2693-67037	page 7-19
Spot Sensor Cable Assembly	K	2	 C2693-67038	page 7-20
Starwheels Assembly	17	2	 C2693-67027	page 7-21
Stopper Assembly	4	1	 C2693-67001	page 7-6

Table 8.3 Alphabetical Parts List

Stopper Guides	34	2	 C2693-67034	page 7-8
Trough-1 Assembly	24,G	3	 C2693-67030	page 7-32
Upper Paper Guide Assembly	20	3	 C2693-67023	page 7-29
Wiper Assembly	C	3	 C2693-67041	page 7-35

Numerical Parts List

Table 8.4 Numerical Parts List













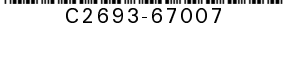
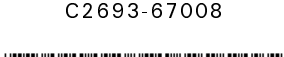

Bar Code with Part Number	Part Description	Exploded Views	Service Level*	For repair information, see
 C2693-67001	Stopper Assembly	4	1	page 7-6
 C2693-67002	Output Tray Assembly	6	1	page 7-6
 C2693-67003	Cleanout Trough Assembly	21, A	1	page 7-7
 C2693-67004	Left End Cap Assembly	2	2	page 7-11
 C2693-67005	Right End Cap Assembly	3	2	page 7-13
 C2693-67006	Keypanel PCA	37	2	page 7-14
 C2693-67007	Power Switch Harness	35	2	page 7-15
 C2693-67008	Access Door Assembly	1, A	2	page 7-9
 C2693-67009	Main Back Panel	A	2	page 7-35
 C2693-67010	Logic PCA Assembly	39	2	page 7-10
 C2693-67011	Power Supply Harness Assembly	D	2	page 7-35
 C2693-67012	Power Supply Assembly	38, D	2	page 7-12
 C2693-67013	Power Insulator	42	2	page 7-13
 C2693-67014	Main Logic Harness Assembly	30	2	page 7-14
 C2693-67015	Encoder Strip	10	2	page 7-17
 C2693-67016	Carriage Belt	11	3	page 7-28

Table 8.4 Numerical Parts List



















 C2693-67017	Carriage Motor Assembly	12	2	page 7-18
 C2693-67018	Pick Roller Assembly	22	2	page 7-25
 C2693-67019	Input Tray Assembly	5	2	page 7-23
 C2693-67020	Drive Roller Assembly	28, F	3	page 7-31
 C2693-67021	Pivot	F	3	page 7-36
 C2693-67022	Pivot Guide	F	3	page 7-36
 C2693-67023	Upper Paper Guide Assembly	20	3	page 7-29
 C2693-67024	Output Mechanism Assembly	18	2	page 7-22
 C2693-67025	Output Belt	23	2	page 7-16
 C2693-67026	Flex Cable	8	3	page 7-28
 C2693-67027	Starwheels Assembly	17	2	page 7-21
 C2693-67028	Base Plate Assembly	31	3	page 7-34
 C2693-67029	Rail Cover	16	2	page 7-21
 C2693-67030	Trough-1 Assembly	24,G	3	page 7-32
 C2693-67031	Encoder Disk Assembly	29	2	page 7-16
 C2693-67032	Pick Separator Assembly	G	3	page 7-36
 C2693-67033	Hand Grabs	32, 33	2	page 7-15
 C2693-67034	Stopper Guides	34	2	page 7-8
 C2693-67035	Carriage Assembly	7, E	3	page 7-27

Table 8.4 Numerical Parts List























 C2693-67036	Carriage PCA	E	3	page 7-28
 C2693-67037	Spot Sensor Assembly	43	2	page 7-19
 C2693-67038	Spot Sensor Cable Assembly	K	2	page 7-20
 C2693-67039	Service Station Mechanism Assembly	27, C	2	page 7-19
 C2693-67040	Service Station Motor Assembly	C	3	page 7-19
 C2693-67041	Wiper Assembly	C	3	page 7-35
 C2693-67042	Sponge	C	3	page 7-19
 C2693-67043	Left Support Assembly	25, H	3	page 7-34
 C2693-67044	Output Motor Assembly	15	2	page 7-23
 C2693-67045	Linefeed/Encoder PCA	13	2	page 7-15
 C2693-67046	Index Sensor Harness	H	2	page 7-35
 C2693-67047	Index Sensor	H	2	page 7-35
 C2693-67048	Backbone Assembly	19, J	3	page 7-29
 C2693-67049	Right Support Assembly	26	3	page 7-33
 C2693-67050	Encoder Guide	14	3	page 7-15
 C2693-67051	ESD Cover	K	2	page 7-20
 C2693-67052	Low Usage Kit 1		2	page 8-7
 C2693-67053	Low Usage Kit 2		2	page 8-7
 C2693-67053	Rubber Feet	36	2	page 7-9

Table 8.4 Numerical Parts List

 C2693-67054	Logic PCA Assembly - EEU	2	page 7-10
 C2693-67055	Printer Brick - AO	2	
 C2693-67056	Printer Brick - EEU	2	

Low Usage Kits

Table 8.5 Low Usage Kits

Low Usage Kit 1	Quantity	Low Usage Kit 2	Quantity	For repair information see
Screw – Carriage Rod	50	Bearing – Right Drive	10	page 7-32
Screw – Mach M3x.57mm	50	Bearing – Left Input	10	page 7-25
Screw – MC M4x8 mm	50	Bearing – Output	10	page 7-22
Screw – MS M4X12 mm	50	Bearing – Right Pick Roller	10	page 7-25
Screw – MS M4x6 mm	50	Blade – ESD	20	page 7-35
Screw – PT M3x9 mm	50	Clip – Ferrite	20	page 7-28
Screw – PT M3x8 mm	50	Foot – Rubber	40	page 7-9
Screw – Lock Down Rail	50	Mount – Rod	50	page 7-33
Screw – Shoulder, M3X0.5 mm	50	Roller – Trough	50	page 7-35
Screw – ST M4x10 mm	50	Sleeve – Drive	10	page 7-31
		Spring – Encoder	20	page 7-35
		Spring – ESD	20	page 7-35
		Spring – Input Kicker	20	page 7-35
		Spring – Pivot	20	page 7-20
		Spring – Preloader	20	page 7-31
		Spring – Rear Roller	50	page 7-35
		Spring – Rocker Plate	20	page 7-20
		Spring – Rod	20	page 7-35
		Spring – Separator	20	page 7-35

Appendix

Table A.1 Language Abbreviations

Language	Abbreviation
Arabic	ARA
Chinese (Simplified)	CHS
Chinese (Traditional)	CHT
Czech	CZE
Danish	DAN
Dutch	DUT
English (US and UK)	ENU
Finnish	FIN
French (European)	FRE
German	GER
Greek	GRE
Hebrew	HEB
Italian	ITA
Japanese	JAP
Korean	KOR
Norwegian	NOR
Polish	POL
Portuguese (European)	POR
Russian	RUS
Spanish	SPA
Swedish	SWE
Turkish	TUR

Index

A

- access door 1-9, 7-9, 7-35
 - subassembly parts 7-35
- accessories and supplies 1-17
- acoustic specifications 1-7
- alcohol caution 5-2
- aligning print cartridges 5-9
- alignment mark 4-6
- Apple
 - see Macintosh.*
- area, printable 1-11

B

- backbone assembly
 - removal 7-29
 - subassembly parts 7-36
- base plate assembly 7-34
- blank pages print 6-13, 6-14
- bleeding colors 6-18
- blinking lights 6-9
- born-on date 6-61
- built-in fonts 1-5
- bypass stopper 1-9, 4-5

C

- cable
 - checking the interface 2-9
 - connecting the interface 2-3
 - part numbers 1-17
 - poor connection 6-23
 - specifications 1-7
- calibration 7-37
 - caution 7-39
 - diagnostic test 6-64
- cancel button 3-2
- cards 4-3
- carriage
 - does not move 6-34

- unlocking 7-27
- carriage assembly
 - removal 7-27
 - subassembly parts 7-36
- carriage motor assembly 7-18
- carriage PCA 7-36
- carriage rod 7-27
- carriage stall 6-9, 6-38
- cartridge
 - see print cartridges.*
- cartridge-to-paper spacing
 - see pen-to-paper spacing.*
- cautions
 - calibration 7-39
 - damage of alcohol or other cleaners 5-2
 - electrostatic discharge 7-4
 - encoder strip 7-17
 - refilling print cartridges
 - print cartridges
 - caution 6-51
 - starwheels 7-21
 - starwheels assembly 7-21
- centronics parallel interface
 - cable 1-7
 - cable part number 1-17
- cleaning
 - electrical contacts 5-6
 - print cartridges 5-4
 - printer exterior 5-2
- cleaning the print cartridges 5-4
- cleanout trough
 - removal 7-7
 - subassembly parts 7-35
 - unlocking 7-7
- clearing
 - clogged print cartridge nozzles 6-62

- paper jams 4-7
- color
 - bleeding 6-18
 - fading 6-17
 - fill problems 6-19
 - hues change 6-24
 - prints as shades of gray 6-25
 - smearing 6-18
- ColorSmart III technology 1-3
- computer configuration
 - minimum for printer driver 1-8
 - recommended for printer driver 1-8
- configuration of computer
 - hard disk space 1-8
 - minimum system 1-8
 - printer software 2-6
- consumer removable parts 7-6
- contacts
 - cleaning, print cartridge 6-34
- control panel
 - changing default print settings 3-2, 3-4
 - DOS 3-6
 - restoring factory defaults 3-4
- custom paper 4-2
- customer support 1-23

D

- damaged file or software 6-7
- data sheet, material safety 1-13
- D-cam 7-26
- declaration of conformity 1-15
- deskjet 1220C software diagnostic test 6-72, 7-10
- diagnostic tools 6-27, 6-59
 - calibration diagnostic test 6-64
 - deskjet 1220C software diagnostic test 6-72, 7-10
 - extended diagnostic test 6-66
 - infinite Hs diagnostic test 6-69
 - nozzle pattern diagnostic test 6-51, 6-62
 - page alignment diagnostic test 6-70
 - pen ID diagnostic test 6-68
 - pen recovery diagnostic test 5-4, 6-51, 6-63
 - sample page 6-60
 - self-test 6-59
 - single diagnostic test 6-61

- dimensions 1-7
- disassembly sequence 7-5
- DOS
 - HP DeskJet Control Panel 3-6
 - printer drivers 3-6
 - support 3-6
- dots per inch
 - high resolution mode 1-4
 - print cartridges 1-11
 - resolution 1-4
- draft mode
 - see EconoFast print mode.*
- drive roller assembly
 - removal 7-31
 - subassembly parts 7-36
- drive sleeve 7-31

E

- EconoFast print mode 6-17
- ejecting paper 6-55
- electrical shock warning 7-3
- electrical specifications 1-7
- electrostatic discharge (ESD) 7-4
- encoder disk assembly
 - removal 7-16
- encoder guide 7-15
- encoder spring 7-36
- encoder strip
 - removal 7-17
- energy consumption 1-16
- envelopes 4-2
- environmental specifications 1-7
- error trap codes 6-9
 - decoding blinks 6-41
 - printing out 6-61
- ESD blades 7-36
- ESD cover
 - removal 7-20
- ESD springs 7-36
- estimated usage specifications 1-7
- expiration date, print cartridge 5-7
- exploded views 8-2
- Express Exchange 1-24
- extended diagnostic test 6-66
- external print servers 2-10
 - part number 1-17
- extra time for drying 4-3

F

- factory default settings 3-4
- faded or dull colored printouts 6-17
- fax retrieval system, HP FIRST 1-24
- FCC regulations 1-13
- feeding
 - does not work 6-10, 6-47
 - sheets by hand 4-6
- ferrite 7-28
- ferrite clip 7-28
- firing chamber, of print cartridge 1-2
- firmware revision 6-61, 6-72
- firmware version 6-61, 6-72
- flex cable
 - removal 7-28
- fonts 1-5
 - internal 1-5
 - jagged 6-20
 - PCL default symbol set 6-61
 - print incorrectly 6-24
 - TrueType 6-20, 6-24

H

- hand grabs
 - removal 7-15
- Health Line, HP 1-12
- help, ToolBox 3-7
- home, position of carriage 6-34
- HP 1220C ToolBox 3-7
- HP ASAP 1-24
- HP customer care center 1-21
- HP DeskJet 1220C Quick Checkup 6-28
- HP DeskJet 1220Cse printer 1-17
- HP DeskJet 1220Cxi printer 1-17
- HP DeskJet Control Panel for DOS 3-4, 3-6
- HP Express Exchange 1-24
- HP FIRST 1-24
- HP Health Line 1-12
- HP JetDirect 2-10
- HP telephone support 1-21
- HP web support 1-21
- humid conditions 1-7

I

- I/O stall 6-9, 6-37
- icons, print cartridges 5-3

- incomplete text on printouts 6-19
- index sensor 7-36
- index sensor harness 7-36
- infinite Hs diagnostic test 6-69
- ink buildup 6-19
- ink coverage, affects cartridge life 5-7, 6-53
- ink smear 6-18
- InkJet technology 1-2
- input kicker spring 7-36
- input tray assembly
 - removal 7-23
- installing printer software 2-6
- interface cable
 - connecting 2-3
 - part numbers 1-17
 - verifying connection 2-8
- interface specifications 1-7
- internal fonts 1-5

J

- jagged text on printouts 6-20
- jammed paper
 - clearing 4-7
 - tips 4-7
- JetDirect 2-10

K

- keypanel
 - buttons 3-2
 - LEDs 3-2
 - troubleshooting printer lights 6-9
- keypanel PCA
 - removal 7-14

L

- labels 4-3
- LED safety 1-12, 1-13
- left end cap assembly
 - removal 7-11
- left input bearing
 - removal 7-25
- left support assembly
 - removal 7-34
 - subassembly parts 7-36
- lights blinking 6-9

- linefeed motor 7-14, 7-34
- linefeed/encoder PCA
 - removal 7-15
- loading paper
 - alternative media feed 4-4, 4-5
 - main media tray 4-4
 - rear media feed 4-6
- logic PCA
 - deskjet 1220C software diagnostic test 7-10
 - removal 7-10
- low usage kits 8-21

M

- Macintosh
 - connecting interface cable 2-4
 - control panel 3-4
 - installing printer software 2-7
 - uninstalling printer software 2-13
- main back panel 7-35
- main logic harness assembly
 - removal 7-14
- main paper tray 1-9
- maintenance
 - cleaning the printer 5-2
 - print cartridges 5-3–5-9
 - warning 5-2
- manual feed 1-9
- manufacturing tracking code 6-61
- margins 1-11
- Material Safety Data Sheet 1-13
- media
 - capacity 1-6, 4-7
 - cards 4-3
 - custom paper 4-2
 - envelopes 4-2
 - handling 1-6
 - labels 4-3
 - ordering information 1-19
 - recommended weight 1-7
 - sizes 1-6, 4-2
 - sizes supported 1-6
 - slides 4-3
 - thick cards 4-3
 - tips for selecting 4-2
 - transparencies 4-3
 - types 4-2

- types supported 1-6
- weight 1-7

memory, of printer 1-7

N

- networking
 - external print servers 2-10
 - printer sharing 2-11
 - troubleshooting network printers 6-4
- noise level specifications 1-7
- non-volatile random access memory 6-66, 6-72
- nozzle pattern diagnostic test 6-51, 6-62
- NVRAM 6-66, 6-72

O

- obtaining printer software 1-21
- operating environment 1-7
- optical turn-on energy (OTOE) 6-65
- ordering information 1-17
- out-of-paper, OOPs 6-40
- output bearing
 - removal 7-22
- output belt
 - removal 7-16
- output mechanism assembly
 - removal 7-22
- output motor assembly
 - removal 7-23
- output tray 1-9
 - removal 7-6

P

- page alignment diagnostic test 6-70
- page count 6-61
- pages per month 1-7
- pallet assembly 7-35
- paper
 - cards 4-3
 - custom sizes 4-2
 - eject problems 6-55
 - envelopes 4-2
 - feed problems 6-10, 6-47
 - labels 4-3
 - ordering information 1-19
 - sizes 4-2

- skew problems 6-13
- slides 4-3
- thick cards 4-3
- tips for selecting 4-2
- transparencies 4-3
- types 4-2
- width adjusters 4-4, 4-5
- wrinkling when printed 6-19
- paper guides 1-9
- paper jams
 - clearing 4-7
 - tips 4-7
- paper loading
 - alternative media feed 4-4, 4-5
 - main media tray 4-4
 - rear media feed 4-6
- paper motor stall 6-9
- part numbers
 - HP 1220C printer 1-17
 - interface cable 1-17
 - JetDirect 1-17
 - list 8-3
 - parallel cable 1-17
 - power cord 1-17
 - PPS calibration tool 7-38
 - print cartridges 1-17
 - USB 1-17
- parts
 - access door 1-9
 - bypass stopper 1-9
 - consumer removable 7-6
 - disassembly sequence 7-5
 - exploded views 8-2
 - external view 1-9
 - list of part numbers 8-3
 - main paper tray 1-9
 - output tray 1-9
 - postcard guide 1-9
 - power input 1-10
 - pressure plate 6-48
 - rear media feed 1-9
 - service level 2 7-8
 - service level 3 7-27
- PCA removal 7-4
- PCL 1-5
- PCL default symbol set 6-61
- pen ID diagnostic test 6-68
- pen recovery diagnostic test 5-4, 6-51, 6-63
- pen-to-paper spacing (PPS) 4-3, 7-37
- PhotoREt III 1-2, 6-26
 - and high resolution mode 1-4
- pick roller assembly
 - removal 7-25
- pick separator assembly 7-36
- pivot 7-36, 7-37
- pivot guides 7-36
- pivot spring
 - removal 7-20
- poor print quality 6-16
- port
 - parallel 1-9
 - USB 1-9
- postcard guide 1-9
- power
 - connecting to printer 2-2
 - cord safety 1-14
 - input 1-10
 - printer won't power on 6-30
 - requirements 1-7
 - specifications 1-7
- power button 3-2
- power cord
 - connecting to printer 2-2
 - faulty 6-31
 - part numbers 1-17
- power insulator
 - removal 7-13
- power supply assembly
 - removal 7-12
 - subassembly parts 7-35
- power supply harness assembly 7-35
- power switch harness
 - removal 7-15
- PPS tool 7-38
- preloader spring 7-31
- pressure plate 6-48, 7-24
- print
 - drying time 4-3
 - resolution 1-4
 - side down for loading 4-4
 - speed 1-4
- print cartridges 5-3
 - aligning 5-9

- cleaning 5-4
 - icons 5-3, 6-28
 - identification number 6-68
 - identifying expiration date 5-7
 - ink buildup 6-19
 - ink volume 1-11
 - ink warning 1-12
 - MSDS 1-12
 - nozzles 1-11
 - part numbers 1-11, 1-17
 - pen ID diagnostic test 6-68
 - pen recovery diagnostic test 5-4, 6-63
 - percent ink remaining 6-68
 - poor contact 6-19
 - protective tape 6-50
 - refilling 6-18
 - safety 1-12
 - short print cartridge life 6-53
 - specifications 1-11
 - storing 7-3
 - tips 5-6
 - vertical resolution 1-11
 - warnings 1-12
 - print quality
 - bleeding colors 6-18
 - faded or dull colors 6-17
 - incomplete text 6-19
 - ink smear 6-18
 - jagged text 6-20
 - meaningless characters printed 6-22
 - poor 6-16
 - slow printing 6-25
 - text or graphics cut off 6-22
 - wrong colors 6-24
 - wrong fonts 6-24
 - printable area specifications 1-11
 - printer
 - command language 1-5
 - external view 1-9
 - model 6-61
 - selecting 6-23
 - settings, changing 3-4
 - sharing 2-11
 - printer driver
 - installing 2-6
 - obtaining 1-21
 - uninstalling 2-13
 - verifying installation 2-8
 - printer lights
 - advanced error patterns 6-39
 - basic error patterns 6-37
 - blinking 6-9
 - during normal printing 3-3
 - troubleshooting 6-36
 - printing
 - photographs 4-3
 - sample page 2-2
 - product
 - certifications 1-8
 - positioning 1-2
- R**
- rail cover 7-21
 - RAM
 - specifications 1-8
 - rear media feed 1-9
 - rear roller springs 7-35, 7-36
 - reliability specifications 1-7
 - removable panel
 - see cleanout trough.*
 - removal and replacement
 - consumer removable parts 7-6
 - disassembly sequence 7-5
 - parts serviceable without calibration 7-8
 - serviceable parts that require calibration 7-27
 - strategy 7-3
 - repair strategy 7-3
 - resolution
 - enhancement technology, REt III 1-2
 - of print modes 1-4
 - resume button 3-2
 - right drive bearing 7-31
 - right end cap assembly 7-13
 - right pick roller bearing 7-25
 - right support assembly 7-33
 - rocker plate spring 7-20
 - rod mount 7-33
 - rod spring 7-36
 - rubber feet 7-9

S

- safety
 - declaration of conformity 1-15
 - LED 1-12, 1-13
 - power cord 1-14
 - precautions 1-12
 - print cartridges 1-12
 - Sample page
 - quick checkup 6-28
 - sample page 6-60
 - printing 2-2
 - Self-Test
 - troubleshooting 6-49
 - self-test 2-8, 6-59
 - separator spring 7-36
 - serial number 6-61, 6-72
 - Service 6-34
 - service and support 1-17
 - customer support 1-23
 - HP ASAP 1-24
 - HP Express Exchange 1-24
 - HP media products 1-19
 - HP telephone support 1-21
 - HP web support 1-21
 - ordering information 1-19
 - service station drive shaft 7-35
 - service station mechanism assembly
 - removal 7-19
 - subassembly parts 7-35
 - service station motor assembly 7-35
 - single diagnostic test 6-61
 - skew 6-13
 - slides 4-3
 - drying time 4-3
 - slow printing 6-25
 - special paper 4-3
 - specifications 1-4
 - dimensions 1-7
 - electrical 1-7
 - energy consumption 1-16
 - fonts 1-5
 - humidity 1-7
 - I/O interface 1-7
 - media capacity 1-6
 - media sizes supported 1-6
 - media types supported 1-6
 - noise 1-7
 - operating environment 1-7
 - power 1-7
 - print cartridges 1-11
 - print method 1-4
 - print speed 1-4
 - printable area 1-11
 - printer command language 1-4
 - printer memory 1-7
 - printer weight 1-7
 - product certifications 1-8
 - recommended media weight 1-7
 - reliability and estimated usage 1-7
 - resolution 1-4
 - safety 1-15
 - smart software features 1-5
 - software compatibility 1-5
 - system requirements 1-8
 - temperature 1-7
 - warranty 1-8
 - speed of printing 1-4
 - sponge 7-35
 - spot sensor assembly 7-19
 - spot sensor cable assembly 7-20
 - springs
 - encoder 7-17, 7-36
 - input kicker 7-36
 - rear roller 7-36
 - rod 7-36
 - separator 7-36
 - starter CD 2-6
 - starwheels assembly 7-21
 - stopper assembly 7-6
 - stopper guides 7-8
 - straight paper path 4-6
 - subassembly parts removal 7-35
 - supplies 1-19
 - system configuration
 - minimum for printer 1-8
 - recommended for printer 1-8
- ## T
- telephone support 1-21
 - temperature specifications 1-7
 - text or graphics cut off 6-22
 - Thermal InkJet Technology 1-2
 - ToolBox 3-7
 - tools

- removal and replacement 7-3
- total engine page count 6-61
- transmission belt 7-34
- transparencies 4-3
 - drying time 4-3
- troubleshooting
 - blank pages print 6-13, 6-14
 - diagnostic tools 6-27
 - hardware problems 6-27, 6-29
 - HP DeskJet 1220C Quick Checkup 6-28
 - initialization problems 6-33
 - network printers 6-4
 - paper eject problems 6-55
 - paper feed 6-47
 - paper feed problems 6-10
 - paper skew 6-13
 - poor print quality 6-16
 - power on problems 6-30
 - print cartridges 5-3
 - printer lights blink 6-9
 - printer not responding 6-6
 - Self-Test 6-49
 - slow printing 6-25
 - software problems 6-3
 - strategy 6-2
 - ToolBox 3-7
 - tools 6-27
 - unexpected results on printouts 6-21
 - unusual noises 6-57
 - using LEDs 6-36
- trough rollers 7-35, 7-36
- trough-1 assembly
 - removal 7-32
 - subassembly removal 7-36

U

- unexpected results
 - meaningless characters printed 6-22
 - text or graphics cut off 6-22
 - wrong colors 6-24
 - wrong fonts 6-24
- uninstalling printer software 2-13
- unusual noises 6-57
- upper paper guide assembly
 - removal 7-29
- USB
 - connecting 2-3

- part number 1-17
- port 1-9

V

- vertical alignment 1-4
- voltage
 - logic PCA 6-31
 - power cord 6-31
 - power supply assembly 6-31

W

- warnings
 - cleaning the printer 5-2
 - electrical shock 7-3
 - print cartridge ink 1-12
 - print cartridges 1-12
 - printer maintenance 5-2
- warranty 1-24, 1-26
- weight, printer 1-7
- wiper assembly 7-35
- wrong colors print 6-24



© Copyright 2000
Hewlett-Packard Company

Manual Part no. C2693-67058

<http://bpd.sgp.hp.com/support>